

# Drawing UML with PlantUML

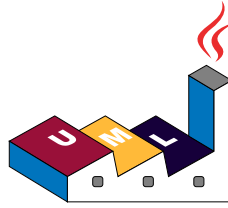

## PlantUML Language Reference Guide

(Version 1.2023.11)

**PlantUML** is a component that allows to quickly write :

- Sequence diagram
- Usecase diagram
- Class diagram
- Object diagram
- Activity diagram
- Component diagram
- Deployment diagram
- State diagram
- Timing diagram

The following non-UML diagrams are also supported:

- JSON Data
- YAML Data
- Network diagram (nwdiag)
- Wireframe graphical interface
- Archimate diagram
- Specification and Description Language (SDL)
- Dita diagram
- Gantt diagram
- MindMap diagram
- Work Breakdown Structure diagram
- Mathematic with AsciiMath or JLaTeXMath notation
- Entity Relationship diagram

Diagrams are defined using a simple and intuitive language.

# 1 Sequence Diagram

Creating sequence diagrams with PlantUML is remarkably straightforward. This ease of use is largely attributed to the user-friendly nature of its syntax, designed to be both intuitive and easy to remember.

- **Intuitive Syntax:**

First and foremost, users appreciate the straightforward and intuitive syntax that PlantUML employs. This well-thought-out design means that even those new to diagram creation find it easy to grasp the basics quickly and without hassle.

- **Text-to-Graphic Correlation:**

Another distinguishing feature is the close resemblance between the textual representation and the graphical output. This harmonious correlation ensures that the textual drafts translate quite accurately into graphical diagrams, providing a cohesive and predictable design experience without unpleasant surprises in the final output.

- **Efficient Crafting Process:**

The strong correlation between the text and the graphical result not only simplifies the crafting process but also significantly speeds it up. Users benefit from a more streamlined process with fewer requirements for time-consuming revisions and adjustments.

- **Visualization While Drafting:**

The ability to envisage the final graphical outcome while drafting the text is a feature that many find invaluable. It naturally fosters a smooth transition from initial draft to final presentation, enhancing productivity and reducing the likelihood of errors.

- **Easy Edits and Revisions:**

Importantly, editing existing diagrams is a hassle-free process. Since the diagrams are generated from text, users find that making adjustments is considerably easier and more precise than altering an image using graphical tools. It boils down to simply modifying the text, a process far more straightforward and less prone to errors than making changes through a graphical interface with a mouse.

PlantUML facilitates a straightforward and user-friendly approach to creating and editing sequence diagrams, meeting the needs of both novices and seasoned designers alike. It skillfully leverages the simplicity of textual inputs to craft visually descriptive and accurate diagrams, thereby establishing itself as a must-have tool in the diagram creation toolkit.

You can learn more about some of the common commands in PlantUML to enhance your diagram creation experience.

## 1.1 Basic Examples

In PlantUML sequence diagrams, the `->` sequence denotes a message sent between two participants, which are automatically recognized and do not need to be declared beforehand.

Utilize dotted arrows by employing the `-->` sequence, offering a distinct visualization in your diagrams.

To improve readability without affecting the visual representation, use reverse arrows like `<-` or `<--`. However, be aware that this is specifically for sequence diagrams and the rules differ for other diagram types.

```
@startuml
Alice -> Bob: Authentication Request
Bob --> Alice: Authentication Response

Alice -> Bob: Another authentication Request
Alice <-- Bob: Another authentication Response
@enduml
```



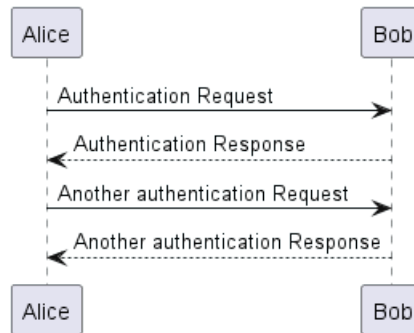

## 1.2 Declaring participant

If the keyword `participant` is used to declare a participant, more control on that participant is possible.

The order of declaration will be the (default) **order of display**.

Using these other keywords to declare participants will **change the shape** of the participant representation:

- actor
- boundary
- control
- entity
- database
- collections
- queue

```

@startuml
participant Participant as Foo
actor Actor as Foo1
boundary Boundary as Foo2
control Control as Foo3
entity Entity as Foo4
database Database as Foo5
collections Collections as Foo6
queue Queue as Foo7
Foo -> Foo1 : To actor
Foo -> Foo2 : To boundary
Foo -> Foo3 : To control
Foo -> Foo4 : To entity
Foo -> Foo5 : To database
Foo -> Foo6 : To collections
Foo -> Foo7: To queue
@enduml
  
```

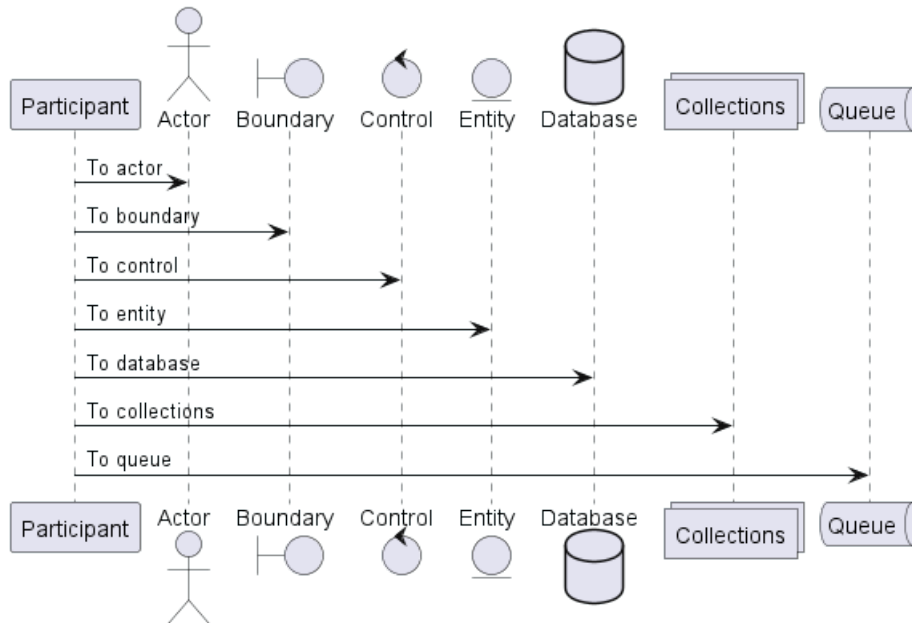

Rename a participant using the `as` keyword.

You can also change the background color of actor or participant.

```
@startuml
actor Bob #red
' The only difference between actor
'and participant is the drawing
participant Alice
participant "I have a really\nlong name" as L #99FF99
/' You can also declare:
    participant L as "I have a really\nlong name" #99FF99
  '/
```

```
Alice->Bob: Authentication Request
Bob->Alice: Authentication Response
Bob->L: Log transaction
@enduml
```

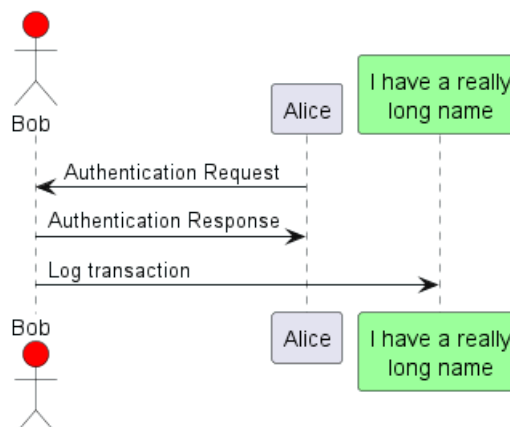

You can use the `order` keyword to customize the display order of participants.

```
@startuml
participant Last order 30
participant Middle order 20
participant First order 10
```



```
@enduml
```

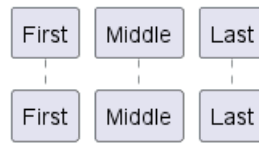

### 1.3 Declaring participant on multiline

You can declare participant on multi-line.

```
@startuml
participant Participant [
  =Title
  ----
  ""SubTitle""
]
```

```
participant Bob
```

```
Participant -> Bob
@enduml
```

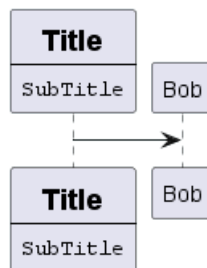

[Ref. QA-15232]

### 1.4 Use non-letters in participants

You can use quotes to define participants. And you can use the `as` keyword to give an alias to those participants.

```
@startuml
Alice -> "Bob()" : Hello
"Bob()" -> "This is very\nlong" as Long
' You can also declare:
' "Bob()" -> Long as "This is very\nlong"
Long --> "Bob()" : ok
@enduml
```

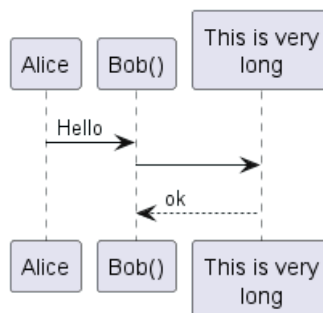

## 1.5 Message to Self

A participant can send a message to itself.

It is also possible to have multi-line using `.`

```
@startuml
Alice -> Alice: This is a signal to self.\nIt also demonstrates\nmultiline \ntext
@enduml
```

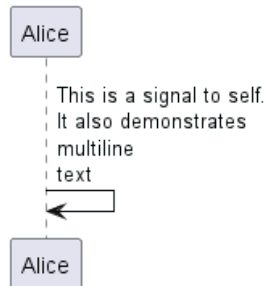

```
@startuml
Alice <- Alice: This is a signal to self.\nIt also demonstrates\nmultiline \ntext
@enduml
```

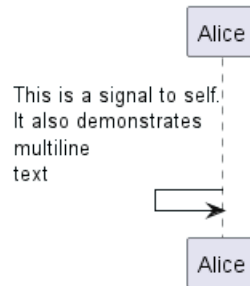

[Ref. QA-1361]

## 1.6 Text alignment

Text alignment on arrows can be set to `left`, `right` or `center` using skinparam `sequenceMessageAlign`.

You can also use `direction` or `reverseDirection` to align text depending on arrow direction. Further details and examples of this are available on the skinparam page.

```
@startuml
skinparam sequenceMessageAlign right
Bob -> Alice : Request
Alice -> Bob : Response
@enduml
```

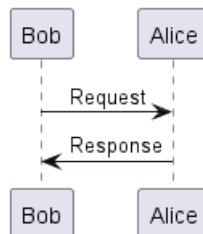

### 1.6.1 Text of response message below the arrow

You can put the text of the response message below the arrow, with the skinparam `responseMessageBelowArrow true` command.



```

@startuml
skinparam responseMessageBelowArrow true
Bob -> Alice : hello
Alice -> Bob : ok
@enduml

```

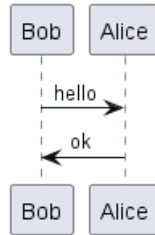

## 1.7 Change arrow style

You can change arrow style by several ways:

- add a final x to denote a lost message
- use \ or / instead of < or > to have only the bottom or top part of the arrow
- repeat the arrow head (for example, >> or //) head to have a thin drawing
- use -- instead of - to have a dotted arrow
- add a final "o" at arrow head
- use bidirectional arrow <->

```

@startuml
Bob ->x Alice
Bob -> Alice
Bob ->> Alice
Bob -\ Alice
Bob \\- Alice
Bob //-- Alice

Bob ->o Alice
Bob o\\-- Alice

Bob <-> Alice
Bob <->o Alice
@enduml

```

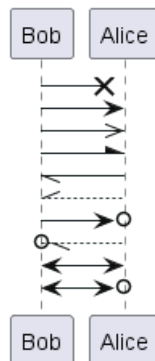

## 1.8 Change arrow color

You can change the color of individual arrows using the following notation:

```

@startuml

```



```

Bob -[#red]> Alice : hello
Alice -[#0000FF]->Bob : ok
@enduml

```

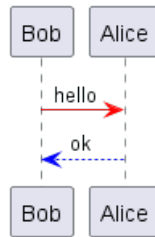

## 1.9 Message sequence numbering

The keyword `autonumber` is used to automatically add an incrementing number to messages.

```

@startuml
autonumber
Bob -> Alice : Authentication Request
Bob <- Alice : Authentication Response
@enduml

```



You can specify a startnumber with `autonumber <start>` , and also an increment with `autonumber <start> <increment>`.

```

@startuml
autonumber
Bob -> Alice : Authentication Request
Bob <- Alice : Authentication Response

autonumber 15
Bob -> Alice : Another authentication Request
Bob <- Alice : Another authentication Response

autonumber 40 10
Bob -> Alice : Yet another authentication Request
Bob <- Alice : Yet another authentication Response

@enduml

```



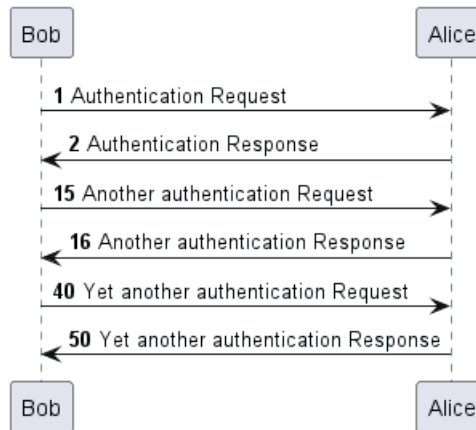

You can specify a format for your number by using between double-quote.

The formatting is done with the Java class `DecimalFormat` (0 means digit, # means digit and zero if absent).

You can use some html tag in the format.

```

@startuml
autonumber "<b>[000]"
Bob -> Alice : Authentication Request
Bob <- Alice : Authentication Response

autonumber 15 "<b>(<u>##</u>)"
Bob -> Alice : Another authentication Request
Bob <- Alice : Another authentication Response

autonumber 40 10 "<font color=red><b>Message 0 "
Bob -> Alice : Yet another authentication Request
Bob <- Alice : Yet another authentication Response

@enduml
  
```

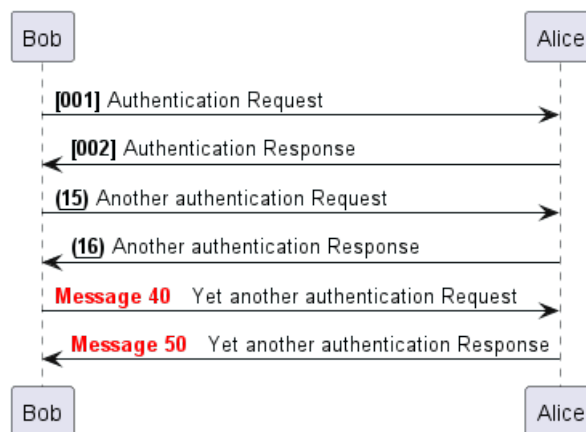

You can also use `autonumber stop` and `autonumber resume <increment> <format>` to respectively pause and resume automatic numbering.

```

@startuml
autonumber 10 10 "<b>[000]"
Bob -> Alice : Authentication Request
Bob <- Alice : Authentication Response

autonumber stop
Bob -> Alice : dummy
  
```



```

autonumber resume "<font color=red><b>Message 0 "
Bob -> Alice : Yet another authentication Request
Bob <- Alice : Yet another authentication Response

autonumber stop
Bob -> Alice : dummy

autonumber resume 1 "<font color=blue><b>Message 0 "
Bob -> Alice : Yet another authentication Request
Bob <- Alice : Yet another authentication Response
@enduml

```

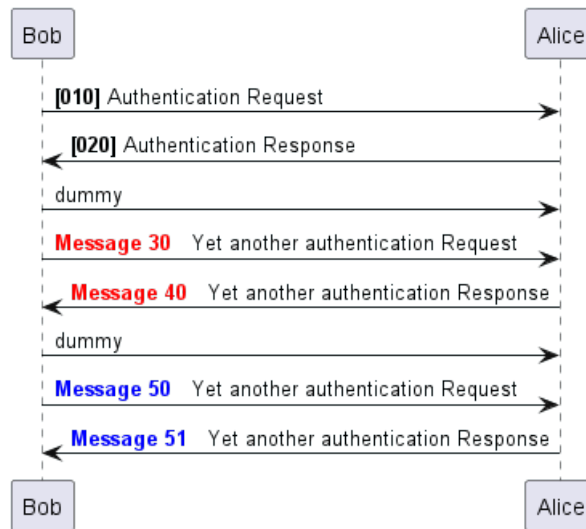

Your startnumber can also be a 2 or 3 digit sequence using a field delimiter such as ., ;, ,, : or a mix of these. For example: 1.1.1 or 1.1:1.

Automatically the last digit will increment.

To increment the first digit, use: `autonumber inc A`. To increment the second digit, use: `autonumber inc B`.

```

@startuml
autonumber 1.1.1
Alice -> Bob: Authentication request
Bob --> Alice: Response

autonumber inc A
'Now we have 2.1.1
Alice -> Bob: Another authentication request
Bob --> Alice: Response

autonumber inc B
'Now we have 2.2.1
Alice -> Bob: Another authentication request
Bob --> Alice: Response

autonumber inc A
'Now we have 3.1.1
Alice -> Bob: Another authentication request
autonumber inc B
'Now we have 3.2.1
Bob --> Alice: Response
@enduml

```





You can also use the value of autonumber with the `%autonumber%` variable:

```

@startuml
autonumber 10
Alice -> Bob
note right
  the <U+0025>autonumber<U+0025> works everywhere.
  Here, its value is ** %autonumber% **
end note
Bob --> Alice: //This is the response %autonumber%//
@enduml
  
```

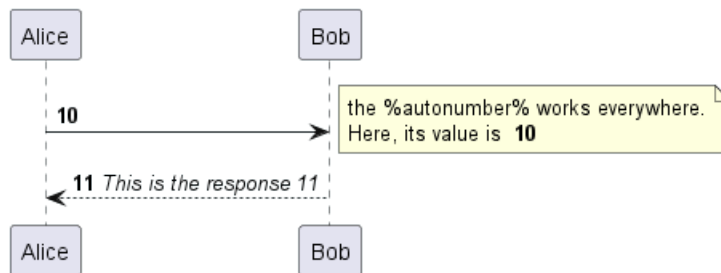

[Ref. QA-7119]

## 1.10 Page Title, Header and Footer

The `title` keyword is used to add a title to the page.

Pages can display headers and footers using `header` and `footer`.

```

@startuml

header Page Header
footer Page %page% of %lastpage%

title Example Title

Alice -> Bob : message 1
Alice -> Bob : message 2

@enduml
  
```



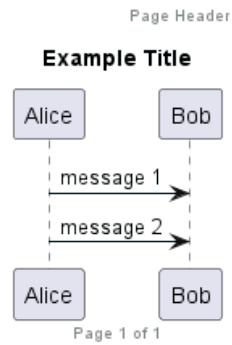

## 1.11 Splitting diagrams

The `newpage` keyword is used to split a diagram into several images.

You can put a title for the new page just after the `newpage` keyword. This title overrides the previously specified title if any.

This is very handy with `Word` to print long diagram on several pages.

(Note: this really does work. Only the first page is shown below, but it is a display artifact.)

```
@startuml
```

```
Alice -> Bob : message 1
Alice -> Bob : message 2
```

```
newpage
```

```
Alice -> Bob : message 3
Alice -> Bob : message 4
```

```
newpage A title for the\nlast page
```

```
Alice -> Bob : message 5
Alice -> Bob : message 6
@enduml
```

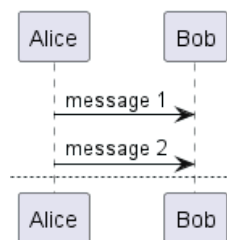

## 1.12 Grouping message

It is possible to group messages together using the following keywords:

- `alt/else`
- `opt`
- `loop`
- `par`
- `break`
- `critical`



- `group`, followed by a text to be displayed

It is possible to add a text that will be displayed into the header (for `group`, see next paragraph 'Secondary group label').

The `end` keyword is used to close the group.

Note that it is possible to nest groups.

```
@startuml
Alice -> Bob: Authentication Request

alt successful case

    Bob -> Alice: Authentication Accepted

else some kind of failure

    Bob -> Alice: Authentication Failure
    group My own label
    Alice -> Log : Log attack start
        loop 1000 times
            Alice -> Bob: DNS Attack
        end
    Alice -> Log : Log attack end
end

else Another type of failure

    Bob -> Alice: Please repeat

end
@enduml
```

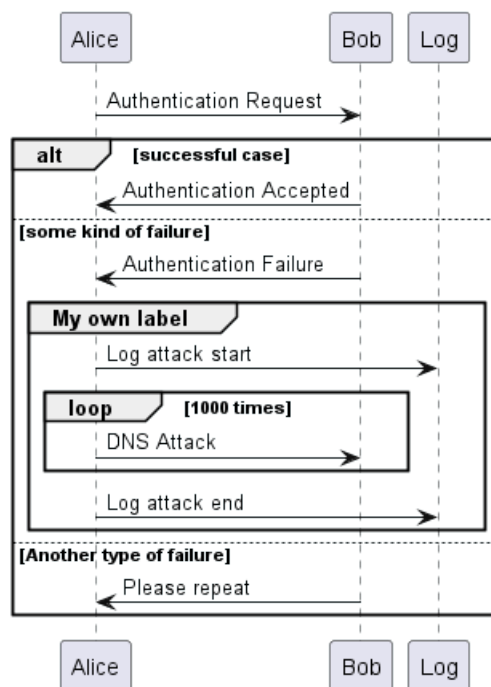

### 1.13 Secondary group label

For `group`, it is possible to add, between [ and ], a secondary text or label that will be displayed into the header.

```

@startuml
Alice -> Bob: Authentication Request
Bob -> Alice: Authentication Failure
group My own label [My own label 2]
  Alice -> Log : Log attack start
  loop 1000 times
    Alice -> Bob: DNS Attack
  end
  Alice -> Log : Log attack end
end
@enduml

```

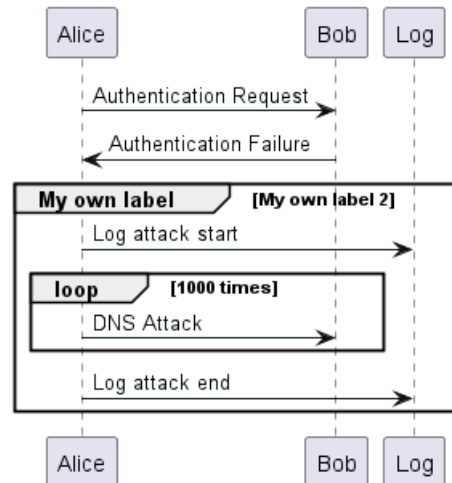

[Ref. QA-2503]

## 1.14 Notes on messages

It is possible to put notes on message using the `note left` or `note right` keywords *just after the message*.

You can have a multi-line note using the `end note` keywords.

```

@startuml
Alice->Bob : hello
note left: this is a first note

Bob->Alice : ok
note right: this is another note

Bob->Bob : I am thinking
note left
a note
can also be defined
on several lines
end note
@enduml

```



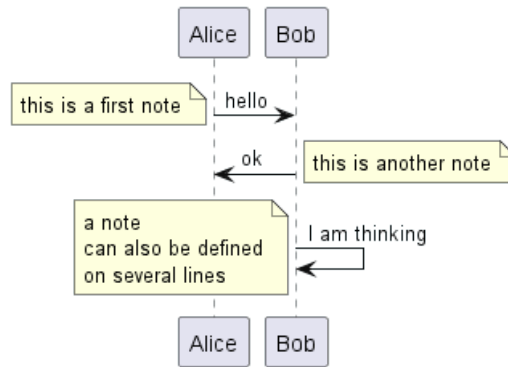

## 1.15 Some other notes

It is also possible to place notes relative to participant with `note left of`, `note right of` or `note over` keywords.

It is possible to highlight a note by changing its background color.

You can also have a multi-line note using the `end note` keywords.

```

@startuml
participant Alice
participant Bob
note left of Alice #aqua
This is displayed
left of Alice.
end note
  
```

```

note right of Alice: This is displayed right of Alice.
  
```

```

note over Alice: This is displayed over Alice.
  
```

```

note over Alice, Bob #FFAAAA: This is displayed\n over Bob and Alice.
  
```

```

note over Bob, Alice
This is yet another
example of
a long note.
end note
@enduml
  
```

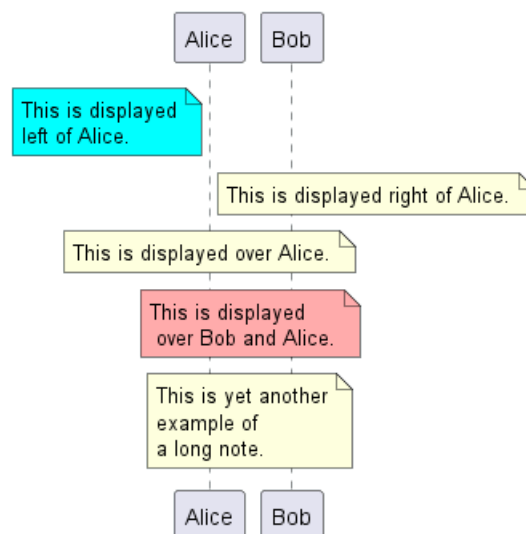

## 1.16 Changing notes shape [hnote, rnote]

You can use `hnote` and `rnote` keywords to change note shapes :

- `hnote` for hexagonal note;
- `rnote` for rectangle note.

```
@startuml
caller -> server : conReq
hnote over caller : idle
caller <- server : conConf
rnote over server
  "r" as rectangle
  "h" as hexagon
endrnote
rnote over server
  this is
  on several
  lines
endrnote
hnote over caller
  this is
  on several
  lines
endhnote
@enduml
```

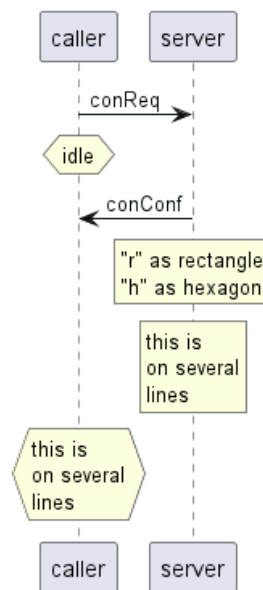

[Ref. QA-1765]

## 1.17 Note over all participants [across]

You can directly make a note over all participants, with the syntax:

- `note across: note_description`

```
@startuml
Alice->Bob:m1
Bob->Charlie:m2
note over Alice, Charlie: Old method for note over all part. with:\n ""note over //FirstPart, LastPart
note across: New method with:\n""note across""
Bob->Alice
hnote across:Note across all part.
```





```
@enduml
```

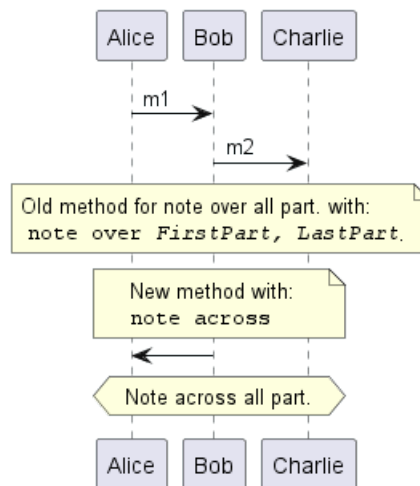

[Ref. QA-9738]

## 1.18 Several notes aligned at the same level [//]

You can make several notes aligned at the same level, with the syntax /:

- without / (by default, the notes are not aligned)

```
@startuml
note over Alice : initial state of Alice
note over Bob : initial state of Bob
Bob -> Alice : hello
@enduml
```

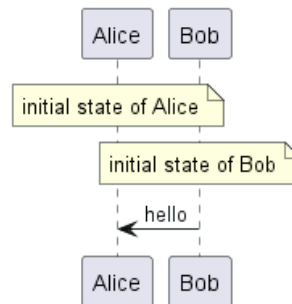

- with / (the notes are aligned)

```
@startuml
note over Alice : initial state of Alice
/ note over Bob : initial state of Bob
Bob -> Alice : hello
@enduml
```

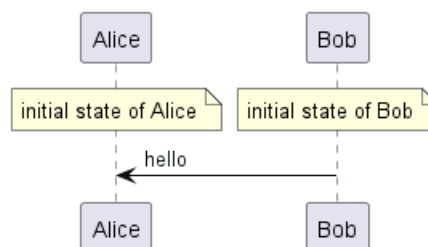

[Ref. QA-354]



## 1.19 Creole and HTML

It is also possible to use creole formatting:

```
@startuml
participant Alice
participant "The Famous Bob" as Bob

Alice -> Bob : hello --there--
... Some --long delay-- ...
Bob -> Alice : ok
note left
  This is bold
  This is italics
  This is "monospaced"
  This is --stroked--
  This is underlined
  This is ~waved~
end note

Alice -> Bob : A //well formatted// message
note right of Alice
  This is <back:cadetblue><size:18>displayed</size></back>
  __left of__ Alice.
end note
note left of Bob
  <u:red>This</u> is <color #118888>displayed</color>
  <color purple>left of</color> <s:red>Alice</strike> Bob</b>*.
end note
note over Alice, Bob
  <w:#FF33FF>This is hosted</w> by <img sourceforge.jpg>
end note
@enduml
```

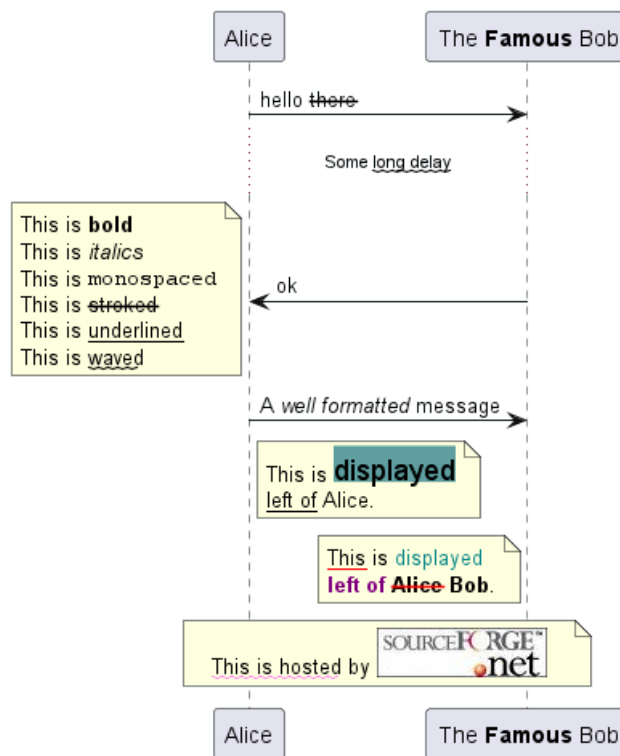

## 1.20 Divider or separator

If you want, you can split a diagram using == separator to divide your diagram into logical steps.

```
@startuml

== Initialization ==

Alice -> Bob: Authentication Request
Bob --> Alice: Authentication Response

== Repetition ==

Alice -> Bob: Another authentication Request
Alice <-- Bob: another authentication Response

@enduml
```

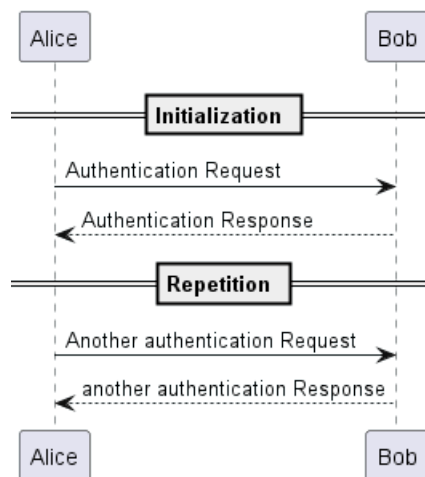

## 1.21 Reference

You can use reference in a diagram, using the keyword `ref over`.

```
@startuml
participant Alice
actor Bob

ref over Alice, Bob : init

Alice -> Bob : hello

ref over Bob
    This can be on
    several lines
end ref
@enduml
```

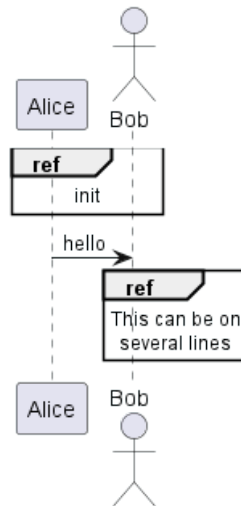

## 1.22 Delay

You can use ... to indicate a delay in the diagram. And it is also possible to put a message with this delay.

```
@startuml
```

```
Alice -> Bob: Authentication Request
```

```
...
```

```
Bob --> Alice: Authentication Response
```

```
...5 minutes later...
```

```
Bob --> Alice: Good Bye !
```

```
@enduml
```

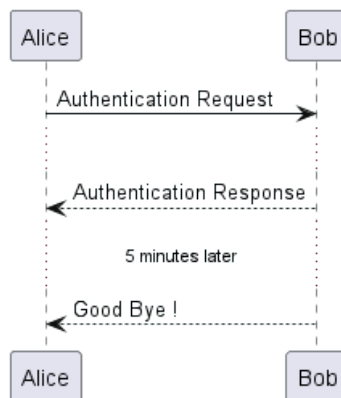

## 1.23 Text wrapping

To break long messages, you can manually add \n in your text.

Another option is to use maxMessageSize setting:

```
@startuml
```

```
skinparam maxMessageSize 50
```

```
participant a
```

```
participant b
```

```
a -> b :this\nis\nmanually\ndone
```

```
a -> b :this is a very long message on several words
```

```
@enduml
```



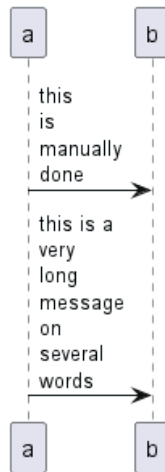

## 1.24 Space

You can use `|||` to indicate some spacing in the diagram.

It is also possible to specify a number of pixel to be used.

```

@startuml

Alice -> Bob: message 1
Bob --> Alice: ok
|||
Alice -> Bob: message 2
Bob --> Alice: ok
||45||
Alice -> Bob: message 3
Bob --> Alice: ok

@enduml
  
```

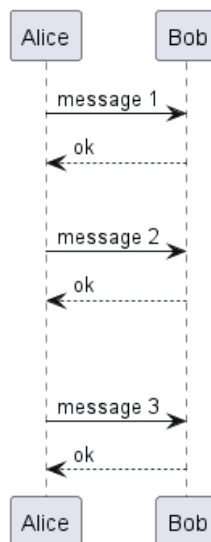

## 1.25 Lifeline Activation and Destruction

The `activate` and `deactivate` are used to denote participant activation.

Once a participant is activated, its lifeline appears.

The `activate` and `deactivate` apply on the previous message.



The destroy denote the end of the lifeline of a participant.

```

@startuml
participant User

User -> A: DoWork
activate A

A -> B: << createRequest >>
activate B

B -> C: DoWork
activate C
C --> B: WorkDone
destroy C

B --> A: RequestCreated
deactivate B

A -> User: Done
deactivate A

@enduml

```

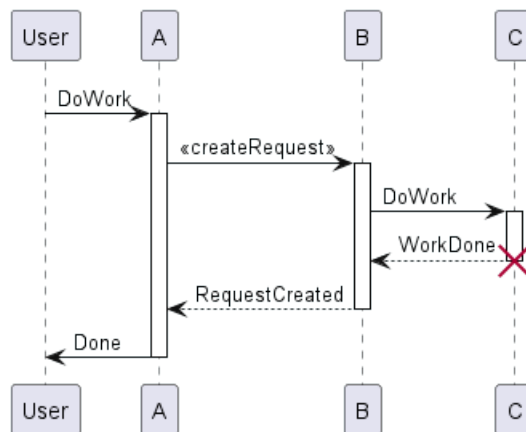

Nested lifeline can be used, and it is possible to add a color on the lifeline.

```

@startuml
participant User

User -> A: DoWork
activate A #FFBBBB

A -> A: Internal call
activate A #DarkSalmon

A -> B: << createRequest >>
activate B

B --> A: RequestCreated
deactivate B
deactivate A

A -> User: Done
deactivate A

@enduml

```



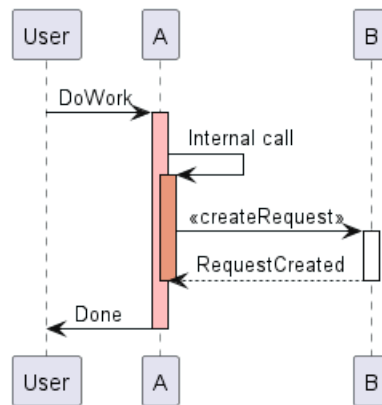

Autoactivation is possible and works with the return keywords:

```

@startuml
autoactivate on
alice -> bob : hello
bob -> bob : self call
bill -> bob #005500 : hello from thread 2
bob -> george ** : create
return done in thread 2
return rc
bob -> george !! : delete
return success
@enduml
  
```

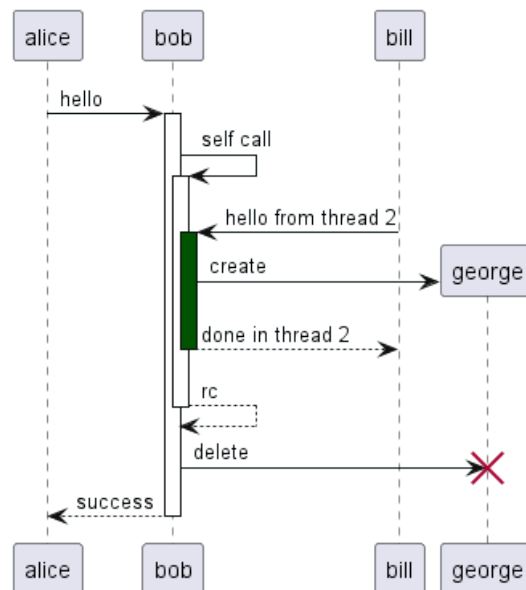

## 1.26 Return

Command `return` generates a return message with optional text label.

The return point is that which caused the most recent life-line activation.

The syntax is `return label` where `label` if provided is any string acceptable for conventional messages.

```

@startuml
Bob -> Alice : hello
activate Alice
Alice -> Alice : some action
  
```



```
return bye
@enduml
```

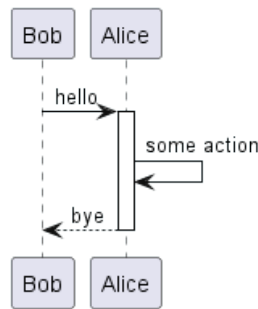

## 1.27 Participant creation

You can use the `create` keyword just before the first reception of a message to emphasize the fact that this message is actually *creating* this new object.

```
@startuml
Bob -> Alice : hello

create Other
Alice -> Other : new

create control String
Alice -> String
note right : You can also put notes!

Alice --> Bob : ok

@enduml
```

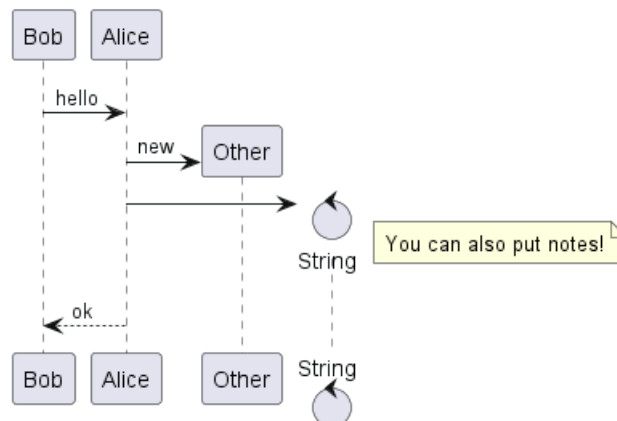

## 1.28 Shortcut syntax for activation, deactivation, creation

Immediately after specifying the target participant, the following syntax can be used:

- ++ Activate the target (optionally a color may follow this)
- -- Deactivate the source
- \*\* Create an instance of the target
- !! Destroy an instance of the target

```
@startuml
alice -> bob ++ : hello
```





```

bob -> bob ++ : self call
bob -> bib ++ #005500 : hello
bob -> george ** : create
return done
return rc
bob -> george !! : delete
return success
@enduml

```

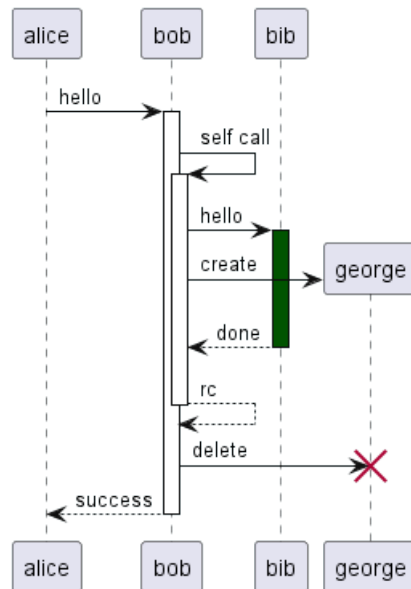

Then you can mix activation and deactivation, on same line:

```

@startuml
alice -> bob ++ : hello1
bob -> charlie ---+ : hello2
charlie --> alice -- : ok
@enduml

```

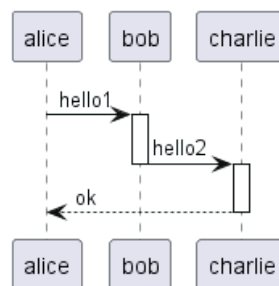

```

@startuml
@startuml
alice -> bob ---+ #gold: hello
bob -> alice ---+ #gold: you too
alice -> bob --: step1
alice -> bob : step2
@enduml
@enduml

```

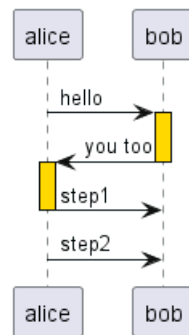

[Ref. QA-4834, QA-9573 and QA-13234]

## 1.29 Incoming and outgoing messages

You can use incoming or outgoing arrows if you want to focus on a part of the diagram.

Use square brackets to denote the left "[" or the right "]" side of the diagram.

```

@startuml
[-> A: DoWork

activate A

A -> A: Internal call
activate A

A ->] : << createRequest >>

A<--] : RequestCreated
deactivate A
[-< A: Done
deactivate A
@enduml
  
```

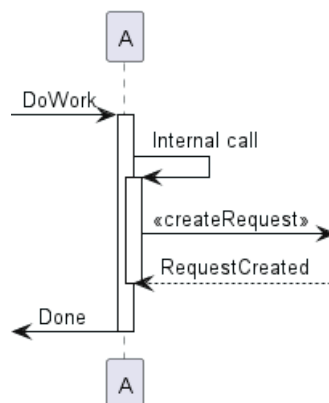

You can also have the following syntax:

```

@startuml
participant Alice
participant Bob #lightblue
Alice -> Bob
Bob -> Carol
...
[-> Bob
[o-> Bob
[o->> Bob
[x-> Bob
  
```



```

...
[<- Bob
[x<- Bob
...
Bob ->]
Bob ->o]
Bob o->o]
Bob ->x]
...
Bob <-]
Bob x<-]

@enduml

```

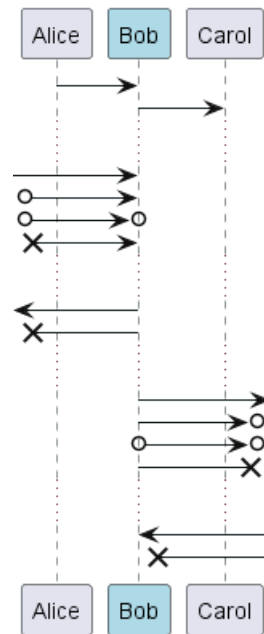

### 1.30 Short arrows for incoming and outgoing messages

You can have **short** arrows with using ?.

```

@startuml
?-> Alice : "?->"\n**short** to actor1
[-> Alice : "[->"\n**from start** to actor1
[-> Bob : "[->"\n**from start** to actor2
?-> Bob : "?->"\n**short** to actor2
Alice ->] : "->]" \nfrom actor1 **to end**
Alice ->? : "->?"\n**short** from actor1
Alice -> Bob : "->" \nfrom actor1 to actor2
@enduml

```

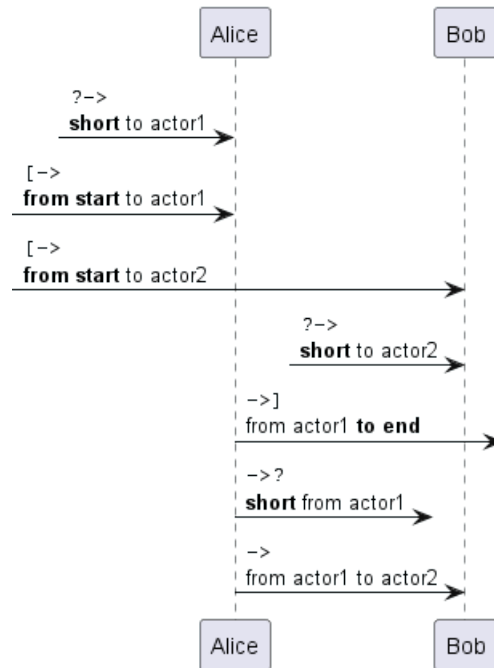

[Ref. QA-310]

### 1.31 Anchors and Duration

With teoz it is possible to add anchors to the diagram and use the anchors to specify duration time.

```

@startuml
!pragma teoz true

{start} Alice -> Bob : start doing things during duration
Bob -> Max : something
Max -> Bob : something else
{end} Bob -> Alice : finish

{start} <-> {end} : some time

@enduml
  
```

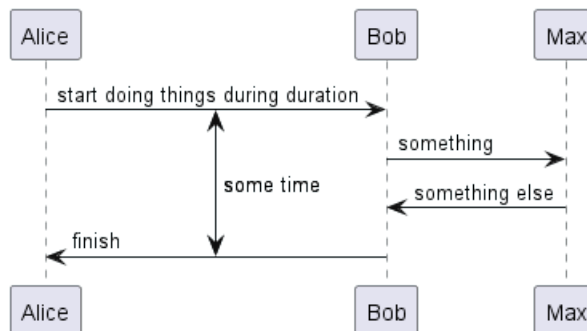

You can use the `-P` command-line option to specify the pragma:

```
java -jar plantuml.jar -Pteoz=true
```

[Ref. issue-582]

### 1.32 Stereotypes and Spots

It is possible to add stereotypes to participants using `<<` and `>>`.



In the stereotype, you can add a spotted character in a colored circle using the syntax (X,color).

```
@startuml
participant "Famous Bob" as Bob << Generated >>
participant Alice << (C,#ADD1B2) Testable >>

Bob->>Alice: First message
@enduml
```

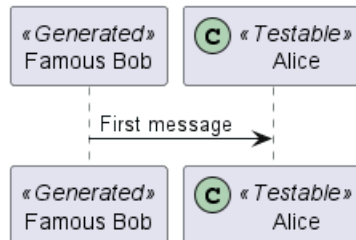

By default, the *guillemet* character is used to display the stereotype. You can change this behaviour using the skinparam *guillemet*:

```
@startuml
skinparam guillemet false
participant "Famous Bob" as Bob << Generated >>
participant Alice << (C,#ADD1B2) Testable >>

Bob->>Alice: First message
@enduml
```

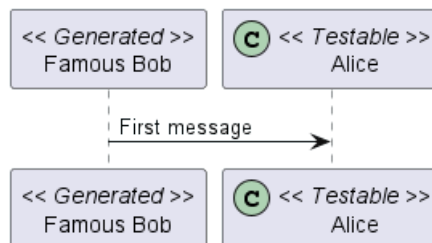

```
@startuml
participant Bob << (C,#ADD1B2) >>
participant Alice << (C,#ADD1B2) >>

Bob->>Alice: First message
@enduml
```

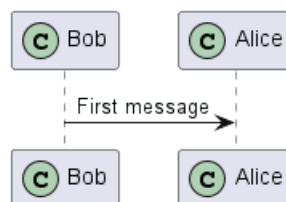

### 1.33 More information on titles

You can use creole formatting in the title.



```

@startuml

title __Simple__ **communication** example

Alice -> Bob: Authentication Request
Bob -> Alice: Authentication Response

@enduml

```

#### Simple communication example

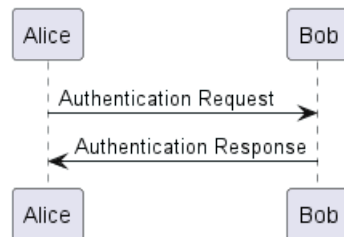

You can add newline using `\n` in the title description.

```

@startuml

title __Simple__ communication example\non several lines

Alice -> Bob: Authentication Request
Bob -> Alice: Authentication Response

@enduml

```

#### Simple communication example on several lines

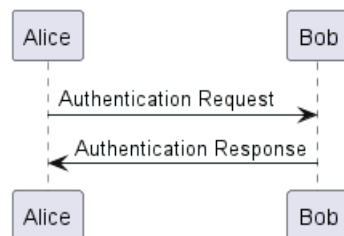

You can also define title on several lines using `title` and `end title` keywords.

```

@startuml

title
  <u>Simple</u> communication example
  on <i>several</i> lines and using <font color=red>html</font>
  This is hosted by <img:sourceforge.jpg>
end title

Alice -> Bob: Authentication Request
Bob -> Alice: Authentication Response

@enduml

```

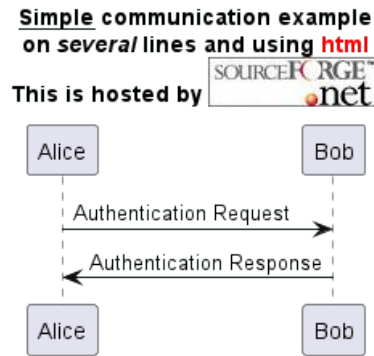

### 1.34 Participants encompass

It is possible to draw a box around some participants, using `box` and `end box` commands.

You can add an optional title or a optional background color, after the `box` keyword.

```

@startuml

box "Internal Service" #LightBlue
  participant Bob
  participant Alice
end box
participant Other

Bob -> Alice : hello
Alice -> Other : hello

@enduml
  
```

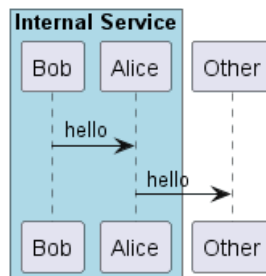

It is also possible to nest boxes - to draw a box within a box - when using the teoz rendering engine, for example:

```

@startuml

!pragma teoz true
box "Internal Service" #LightBlue
  participant Bob
  box "Subteam"
    participant Alice
    participant John
  end box
end box

end box
participant Other

Bob -> Alice : hello
Alice -> John : hello
John -> Other: Hello
  
```



```
@enduml
```

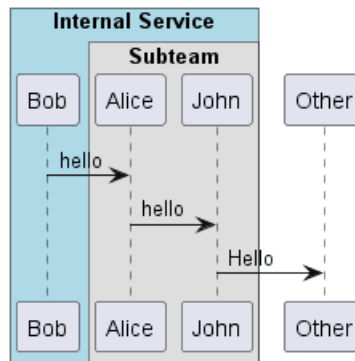

### 1.35 Removing Foot Boxes

You can use the `hide footbox` keywords to remove the foot boxes of the diagram.

```
@startuml
```

```
hide footbox
title Foot Box removed
```

```
Alice -> Bob: Authentication Request
Bob --> Alice: Authentication Response
```

```
@enduml
```



### 1.36 Skinparam

You can use the `skinparam` command to change colors and fonts for the drawing.

You can use this command:

- In the diagram definition, like any other commands,
- In an included file,
- In a configuration file, provided in the command line or the ANT task.

You can also change other rendering parameter, as seen in the following examples:

```
@startuml
skinparam sequenceArrowThickness 2
skinparam roundcorner 20
skinparam maxmessageSize 60
skinparam sequenceParticipant underline
```

```
actor User
participant "First Class" as A
participant "Second Class" as B
participant "Last Class" as C
```





```

User -> A: DoWork
activate A

A -> B: Create Request
activate B

B -> C: DoWork
activate C
C --> B: WorkDone
destroy C

B --> A: Request Created
deactivate B

A --> User: Done
deactivate A

@enduml

```

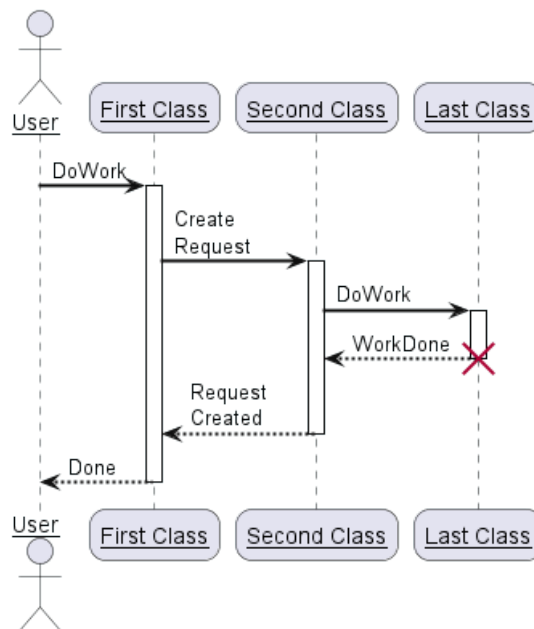

```

@startuml
skinparam backgroundColor #EEEEBCD
skinparam handwritten true

skinparam sequence {
ArrowColor DeepSkyBlue
ActorBorderColor DeepSkyBlue
LifeLineBorderColor blue
LifeLineBackgroundColor #A9DCDF

ParticipantBorderColor DeepSkyBlue
ParticipantBackgroundColor DodgerBlue
ParticipantFontName Impact
ParticipantFontSize 17
ParticipantFontColor #A9DCDF

ActorBackgroundColor aqua
ActorFontColor DeepSkyBlue

```



```

ActorFontSize 17
ActorFontName Apex
}

actor User
participant "First Class" as A
participant "Second Class" as B
participant "Last Class" as C

User -> A: DoWork
activate A

A -> B: Create Request
activate B

B -> C: DoWork
activate C
C --> B: WorkDone
destroy C

B --> A: Request Created
deactivate B

A --> User: Done
deactivate A

@enduml

```

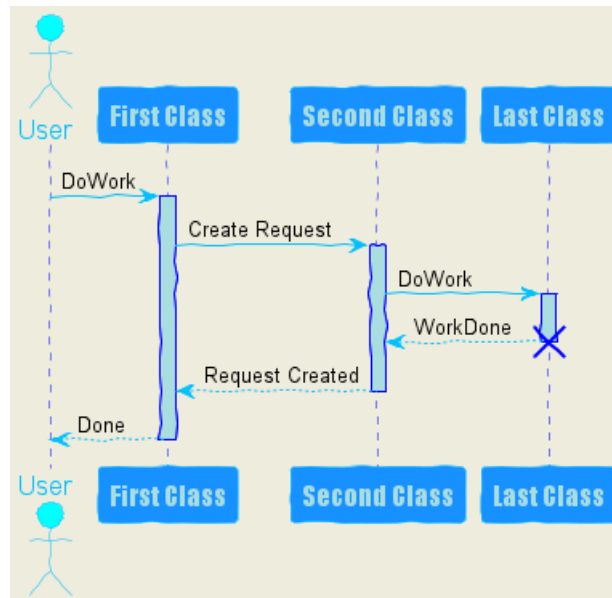

### 1.37 Changing padding

It is possible to tune some padding settings.

```

@startuml
skinparam ParticipantPadding 20
skinparam BoxPadding 10

box "Foo1"
participant Alice1
participant Alice2
end box

```



```

box "Foo2"
participant Bob1
participant Bob2
end box
Alice1 -> Bob1 : hello
Alice1 -> Out : out
@enduml

```

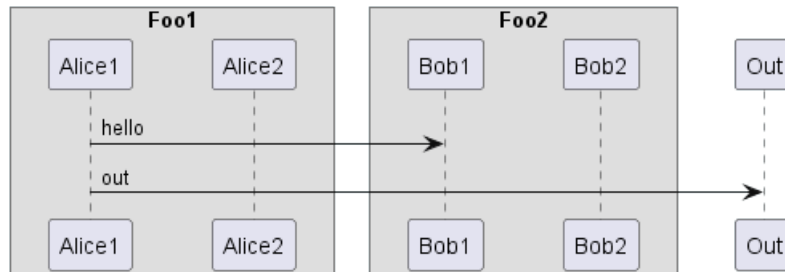

## 1.38 Appendix: Examples of all arrow type

### 1.38.1 Normal arrow

```

@startuml
participant Alice as a
participant Bob as b
a -> b : ""-> ""
a ->> b : ""->> ""
a -\ b : ""-\ ""
a -\\ b : ""-\\o""
a -/ b : ""-/ ""
a -// b : ""-// ""
a ->x b : ""->x ""
a x-> b : ""x-> ""
a o-> b : ""o-> ""
a ->o b : ""->o ""
a o->o b : ""o->o ""
a <-> b : ""<-> ""
a o<->o b : ""o<->o""
a x<->x b : ""x<->x""
a ->>o b : ""->>o ""
a -\o b : ""-\o ""
a -\\o b : ""-\\o""
a -/o b : ""-/o ""
a -//o b : ""-//o ""
a x->o b : ""x->o ""
@enduml

```

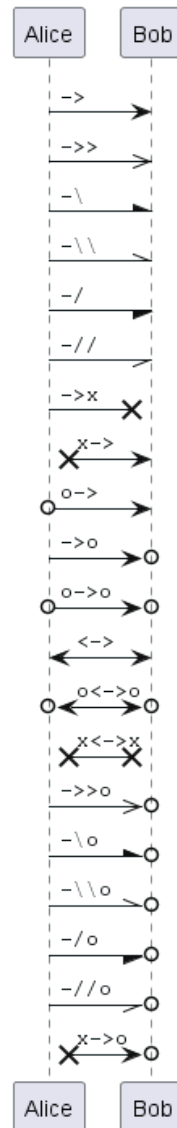

### 1.38.2 Itself arrow

```

@startuml
participant Alice as a
participant Bob as b
a -> a : ""-> ""
a ->> a : ""->> ""
a -\ a : ""-\ ""
a -\\ a : ""-\\ ""
a -/ a : ""-/ ""
a -// a : ""-// ""
a ->x a : ""->x ""
a x-> a : ""x-> ""
a o-> a : ""o-> ""
a ->o a : ""->o ""
a o->o a : ""o->o ""
a <-> a : ""<-> ""
a o<->o a : ""o<->o ""
a x<->x a : ""x<->x ""
a ->>o a : ""->>o ""
a -\o a : ""-\o ""
a -\\o a : ""-\\o ""

```



```

a -/o    a : ""-/o  ""
a -//o   a : ""-//o ""
a x->o   a : ""x->o ""
@enduml

```

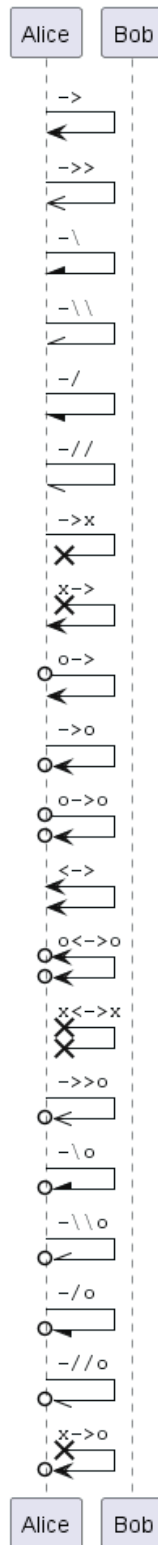

1.38.3 Incoming and outgoing messages (with '[', ']')

1.38.4 Incoming messages (with '[')

```

@startuml

```

```
participant Alice as a
participant Bob as b
[-> b : ""[-> ""
[->> b : ""[->> ""
[-\ b : ""[-\ ""
[-\\ b : ""[-\\\\ ""
[-/ b : ""[-/ ""
[-// b : ""[-// ""
[->x b : ""[->x ""
[x-> b : ""[x-> ""
[o-> b : ""[o-> ""
[->o b : ""[->o ""
[o->o b : ""[o->o ""
[<-> b : ""[<-> ""
[o<->o b : ""[o<->o""
[x<->x b : ""[x<->x""
[->>o b : ""[->>o ""
[-\o b : ""[-\o ""
[-\\o b : ""[-\\\\o""
[-/o b : ""[-/o ""
[-//o b : ""[-//o ""
[x->o b : ""[x->o ""
@enduml
```

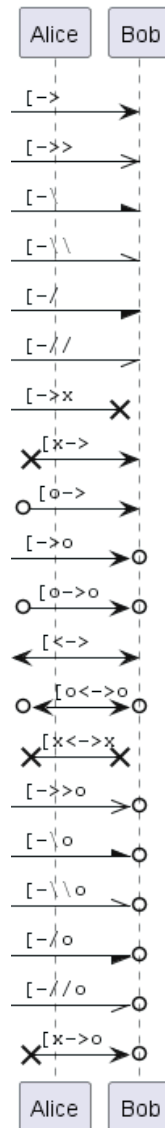

### 1.38.5 Outgoing messages (with '']')

```

@startuml
participant Alice as a
participant Bob as b
a ->] : ""->] ""
a ->>] : ""->>] ""
a -\] : ""-\] ""
a -\\] : ""-\\] ""
a -/] : ""-/] ""
a -//] : ""-//] ""
a ->x] : ""->x] ""
a x->] : ""x->] ""
a o->] : ""o->] ""
a ->o] : ""->o] ""
a o->o] : ""o->o] ""
a <->] : ""<->] ""
a o<->o] : ""o<->o] ""
a x<->x] : ""x<->x] ""
a ->>o] : ""->>o] ""
a -\o] : ""-\o] ""
a -\\o] : ""-\\o] ""

```



```

a -/o]      : ""-/o] ""
a -//o]     : ""-//o] ""
a x->o]     : ""x->o] ""
@enduml

```

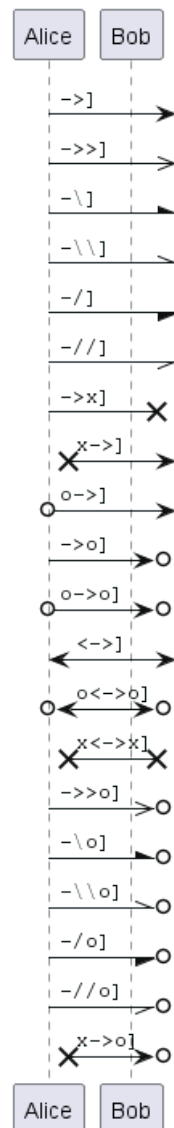

### 1.38.6 Short incoming and outgoing messages (with '?')

### 1.38.7 Short incoming (with '?')

```

@startuml
participant Alice as a
participant Bob as b
a -> b : //Long long label//
?-> b : ""?-> ""
?->> b : ""?->> ""
?-\ b : ""?-\ ""
?-\\ b : ""?-\\\\"""
?-/ b : ""?-/ ""
?-// b : ""?-// ""
?->x b : ""?->x ""
?x-> b : ""?x-> ""
?o-> b : ""?o-> ""
?->o b : ""?->o ""

```





```
?o->o      b : ""?o->o ""
?<->      b : ""?<-> ""
?o<->o    b : ""?o<->o""
?x<->x    b : ""?x<->x""
?->>o     b : ""?->>o ""
?-\o      b : ""?-\o ""
?-\ \o    b : ""?-\ \ \o ""
?-/o      b : ""?-/o ""
?-//o     b : ""?-//o ""
?x->o     b : ""?x->o ""
@enduml
```

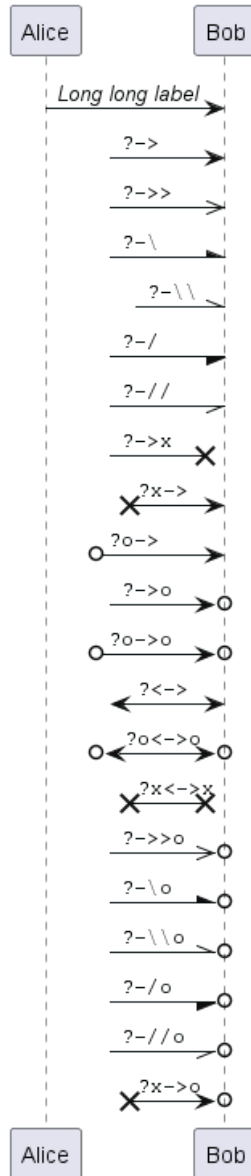

### 1.38.8 Short outgoing (with '?')

```
@startuml
participant Alice as a
participant Bob as b
a -> b : //Long long label//
a ->? : ""->? ""
a ->>? : ""->>? ""
a -\? : ""-\? ""
```

```

a -\\?      : "\"-\\\\\\?\""
a -/?      : "\"-/?  \""
a -//?     : "\"-//?  \""
a ->x?     : "\"->x?  \""
a x->?     : "\"x->?  \""
a o->?     : "\"o->?  \""
a ->o?     : "\"->o?  \""
a o->o?    : "\"o->o?  \""
a <->?     : "\"<->?  \""
a o<->o?  : "\"o<->o?\""
a x<->x?  : "\"x<->x?\""
a ->>o?    : "\"->>o?  \""
a -\o?     : "\"-\o?   \""
a -\\o?    : "\"-\\\\o?  \""
a -/o?     : "\"-/o?   \""
a -//o?    : "\"-//o?  \""
a x->o?    : "\"x->o?  \""
@enduml

```

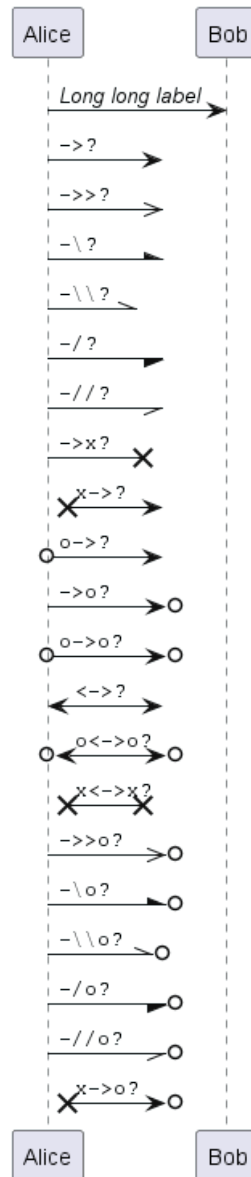

## 1.39 Specific SkinParameter

### 1.39.1 By default

```
@startuml
Bob -> Alice : hello
Alice -> Bob : ok
@enduml
```

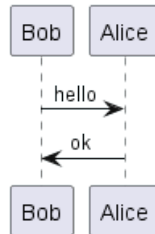

### 1.39.2 LifelineStrategy

- nosolid (*by default*)

```
@startuml
skinparam lifelineStrategy nosolid
Bob -> Alice : hello
Alice -> Bob : ok
@enduml
```

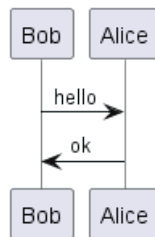

[Ref. QA-9016]

- solid

In order to have solid life line in sequence diagrams, you can use: `skinparam lifelineStrategy solid`

```
@startuml
skinparam lifelineStrategy solid
Bob -> Alice : hello
Alice -> Bob : ok
@enduml
```

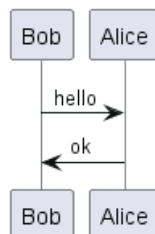

[Ref. QA-2794]

### 1.39.3 style strictuml

To be conform to strict UML (*for arrow style: emits triangle rather than sharp arrowheads*), you can use:

- skinparam style strictuml



```

@startuml
skinparam style strictuml
Bob -> Alice : hello
Alice -> Bob : ok
@enduml

```

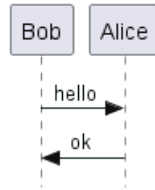

[Ref. QA-1047]

## 1.40 Hide unlinked participant

By default, all participants are displayed.

```

@startuml
participant Alice
participant Bob
participant Carol

Alice -> Bob : hello
@enduml

```

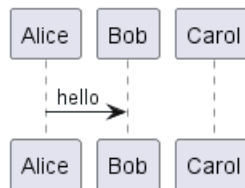

But you can hide unlinked participant.

```

@startuml
hide unlinked
participant Alice
participant Bob
participant Carol

Alice -> Bob : hello
@enduml

```

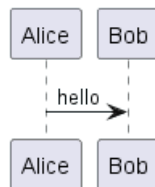

[Ref. QA-4247]

## 1.41 Color a group message

It is possible to color a group messages:

```

@startuml
Alice -> Bob: Authentication Request
alt#Gold #LightBlue Successful case
    Bob -> Alice: Authentication Accepted
end

```



```

else #Pink Failure
  Bob -> Alice: Authentication Rejected
end
@enduml

```

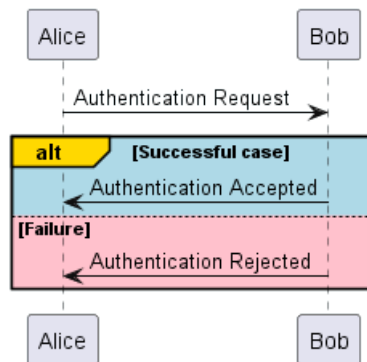

[Ref. QA-4750 and QA-6410]

## 1.42 Mainframe

```

@startuml
mainframe This is a **mainframe**
Alice->Bob : Hello
@enduml

```

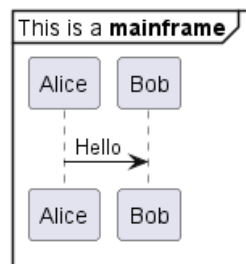

[Ref. QA-4019 and Issue#148]

## 1.43 Slanted or odd arrows

You can use the (nn) option (before or after arrow) to make the arrows slanted, where *nn* is the number of shift pixels.

[Available only after v1.2022.6beta+]

```

@startuml
A ->(10) B: text 10
B ->(10) A: text 10

A ->(10) B: text 10
A (10)<- B: text 10
@enduml

```



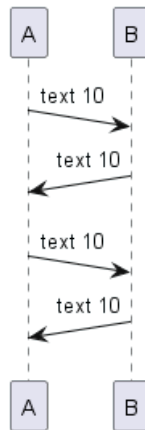

```
@startuml
A ->(40) B+: Rq
B -->(20) A--: Rs
@enduml
```

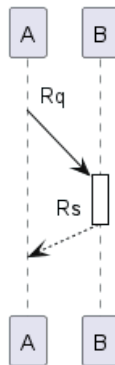

[Ref. QA-14145]

```
@startuml
!pragma teoz true
A ->(50) C: Starts\nwhen 'B' sends
& B ->(25) C: \nBut B's message\n arrives before A's
@enduml
```

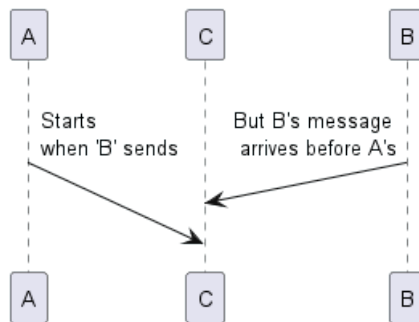

[Ref. QA-6684]

```
@startuml
!pragma teoz true

S1 ->(30) S2: msg 1\n
& S2 ->(30) S1: msg 2

note left S1: msg\nS2 to S1
& note right S2: msg\nS1 to S2
```

@enduml

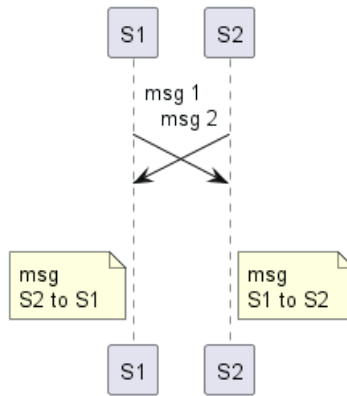

[Ref. QA-1072]

## 2 Use Case Diagram

A **use case diagram** is a visual representation used in software engineering to depict the interactions between **system actors** and the **system itself**. It captures the dynamic behavior of a system by illustrating its **use cases** and the roles that interact with them. These diagrams are essential in specifying the system's **functional requirements** and understanding how users will interact with the system. By providing a high-level view, use case diagrams help stakeholders understand the system's functionality and its potential value.

**PlantUML** offers a unique approach to creating use case diagrams through its text-based language. One of the primary advantages of using PlantUML is its **simplicity and efficiency**. Instead of manually drawing shapes and connections, users can define their diagrams using intuitive and concise textual descriptions. This not only speeds up the diagram creation process but also ensures **consistency and accuracy**. The ability to integrate with various documentation platforms and its wide range of supported output formats make PlantUML a versatile tool for both developers and non-developers. Lastly, being **open-source**, PlantUML boasts a strong community that continually contributes to its improvement and offers a wealth of resources for users at all levels.

### 2.1 Usecases

Use cases are enclosed using between parentheses (because two parentheses looks like an oval).

You can also use the `usecase` keyword to define a usecase. And you can define an alias, using the `as` keyword. This alias will be used later, when defining relations.

```
@startuml
(First usecase)
(Another usecase) as (UC2)
usecase UC3
usecase (Last\nusecase) as UC4

@enduml
```

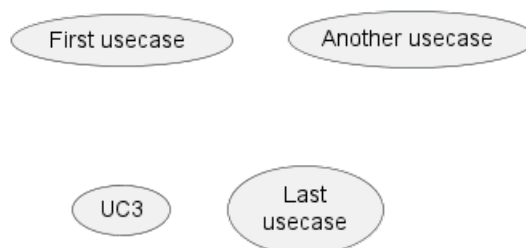

### 2.2 Actors

The name defining an actor is enclosed between colons.

You can also use the `actor` keyword to define an actor. An alias can be assigned using the `as` keyword and can be used later instead of the actor's name, e. g. when defining relations.

You can see from the following examples, that the actor definitions are optional.

```
@startuml
:First Actor:
:Another\nactor: as Man2
actor Woman3
actor :Last actor: as Person1

@enduml
```





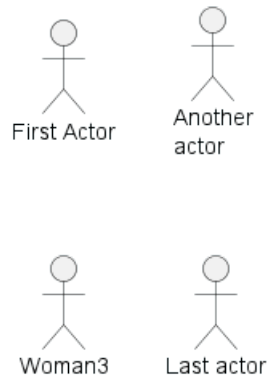

## 2.3 Change Actor style

You can change the actor style from stick man (*by default*) to:

- an awesome man with the `skinparam actorStyle awesome` command;
- a hollow man with the `skinparam actorStyle hollow` command.

### 2.3.1 Stick man (*by default*)

```
@startuml
:User: --> (Use)
"Main Admin" as Admin
"Use the application" as (Use)
Admin --> (Admin the application)
@enduml
```

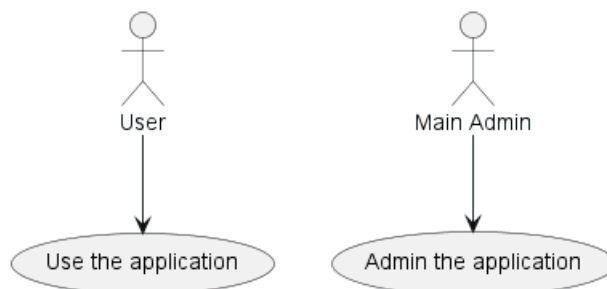

### 2.3.2 Awesome man

```
@startuml
skinparam actorStyle awesome
:User: --> (Use)
"Main Admin" as Admin
"Use the application" as (Use)
Admin --> (Admin the application)
@enduml
```

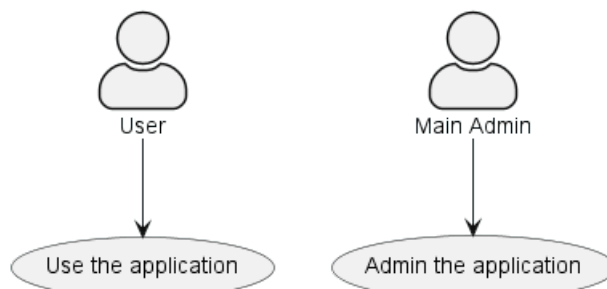

[Ref. QA-10493]

### 2.3.3 Hollow man

```
@startuml
skinparam actorStyle Hollow
:User: --> (Use)
"Main Admin" as Admin
"Use the application" as (Use)
Admin --> (Admin the application)
@enduml
```

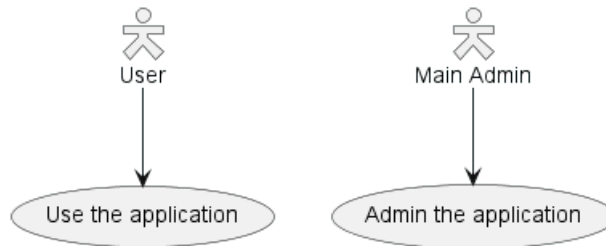

[Ref. PR#396]

## 2.4 Usecases description

If you want to have a description spanning several lines, you can use quotes.

You can also use the following separators:

- -- (dashes)
- .. (periods)
- == (equals)
- \_\_ (underscores)

By using them pairwise and enclosing text between them, you can create separators with titles.

```
@startuml
usecase UC1 as "You can use
several lines to define your usecase.
You can also use separators.
--
Several separators are possible.
==
And you can add titles:
..Conclusion..
This allows large description."
@enduml
```

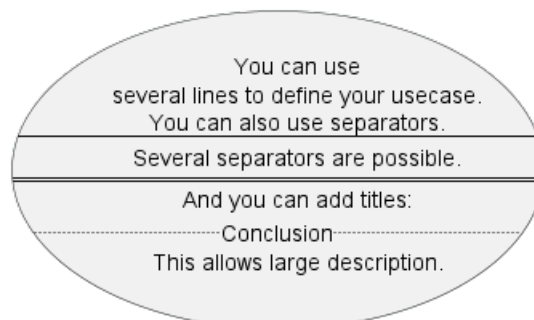

## 2.5 Use package

You can use packages to group actors or use cases.

```

@startuml
left to right direction
actor Guest as g
package Professional {
  actor Chef as c
  actor "Food Critic" as fc
}
package Restaurant {
  usecase "Eat Food" as UC1
  usecase "Pay for Food" as UC2
  usecase "Drink" as UC3
  usecase "Review" as UC4
}
fc --> UC4
g --> UC1
g --> UC2
g --> UC3
@enduml

```

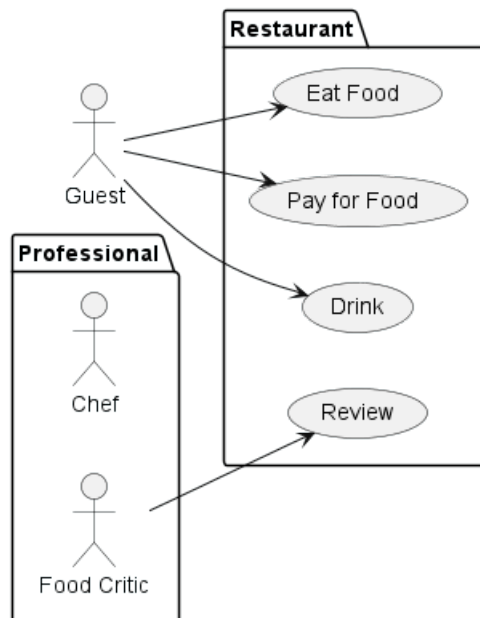

You can use `rectangle` to change the display of the package.

```

@startuml
left to right direction
actor "Food Critic" as fc
rectangle Restaurant {
  usecase "Eat Food" as UC1
  usecase "Pay for Food" as UC2
  usecase "Drink" as UC3
}
fc --> UC1
fc --> UC2
fc --> UC3
@enduml

```

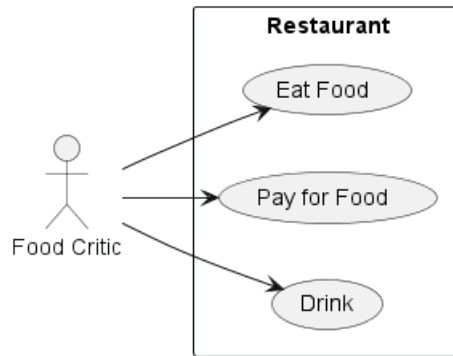

## 2.6 Basic example

To link actors and use cases, the arrow --> is used.

The more dashes - in the arrow, the longer the arrow. You can add a label on the arrow, by adding a : character in the arrow definition.

In this example, you see that *User* has not been defined before, and is used as an actor.

```

@startuml
User -> (Start)
User --> (Use the application) : A small label

:Main Admin: ---> (Use the application) : This is\nyet another\nlabel

@enduml
  
```

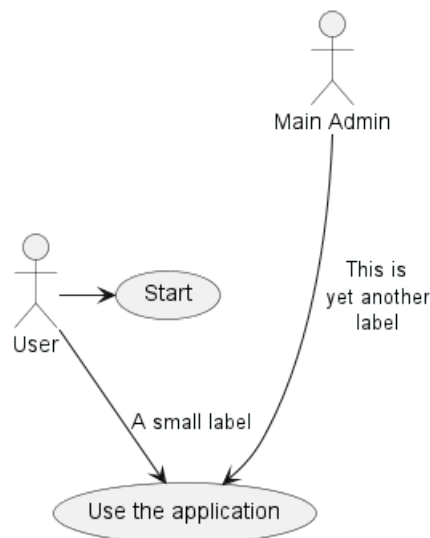

## 2.7 Extension

If one actor/use case extends another one, you can use the symbol <|--.

```

@startuml
:Main Admin: as Admin
(Use the application) as (Use)

User <|-- Admin
(Start) <|-- (Use)

@enduml
  
```



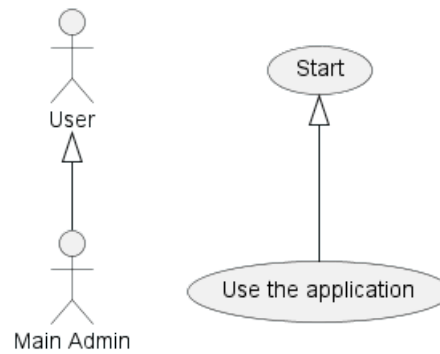

## 2.8 Using notes

You can use the **note left of** , **note right of** , **note top of** , **note bottom of** keywords to define notes related to a single object.

A note can be also define alone with the **note** keywords, then linked to other objects using the **..** symbol.

```

@startuml
:Main Admin: as Admin
(Use the application) as (Use)
  
```

```
User -> (Start)
```

```
User --> (Use)
```

```
Admin ---> (Use)
```

```
note right of Admin : This is an example.
```

```
note right of (Use)
```

```

  A note can also
  be on several lines
end note
  
```

```
note "This note is connected\nto several objects." as N2
```

```
(Start) .. N2
```

```
N2 .. (Use)
```

```
@enduml
```

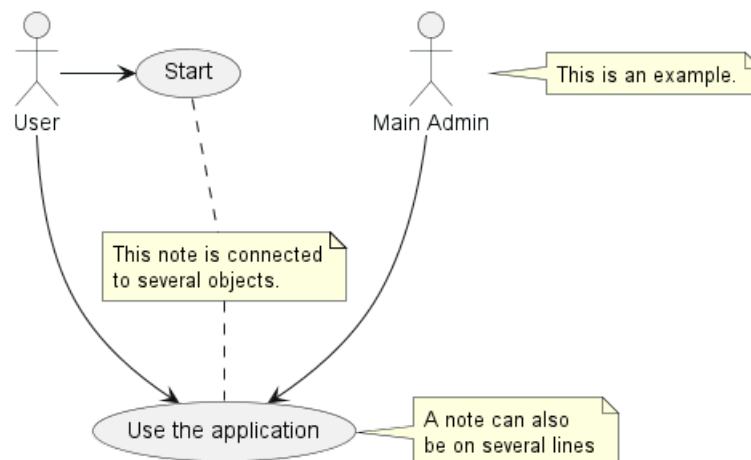

## 2.9 Stereotypes

You can add stereotypes while defining actors and use cases using **<<** and **>>**.



```

@startuml
User << Human >>
:Main Database: as MySQL << Application >>
(Start) << One Shot >>
(Use the application) as (Use) << Main >>

User -> (Start)
User --> (Use)

MySQL --> (Use)

@enduml

```

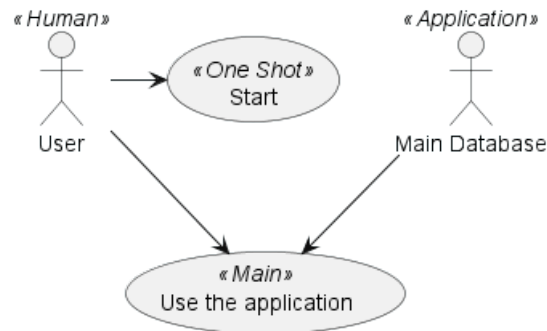

## 2.10 Changing arrows direction

By default, links between classes have two dashes -- and are vertically oriented. It is possible to use horizontal link by putting a single dash (or dot) like this:

```

@startuml
:user: --> (Use case 1)
:user: -> (Use case 2)
@enduml

```

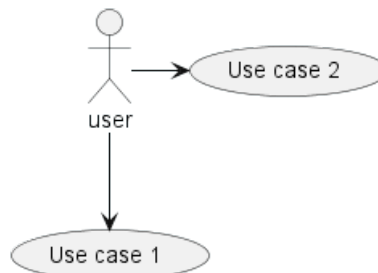

You can also change directions by reversing the link:

```

@startuml
(Use case 1) <.. :user:
(Use case 2) <- :user:
@enduml

```

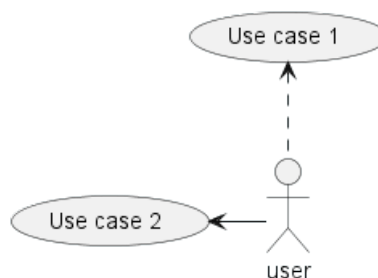

It is also possible to change arrow direction by adding `left`, `right`, `up` or `down` keywords inside the arrow:

```
@startuml
:user: -left-> (dummyLeft)
:user: -right-> (dummyRight)
:user: -up-> (dummyUp)
:user: -down-> (dummyDown)
@enduml
```

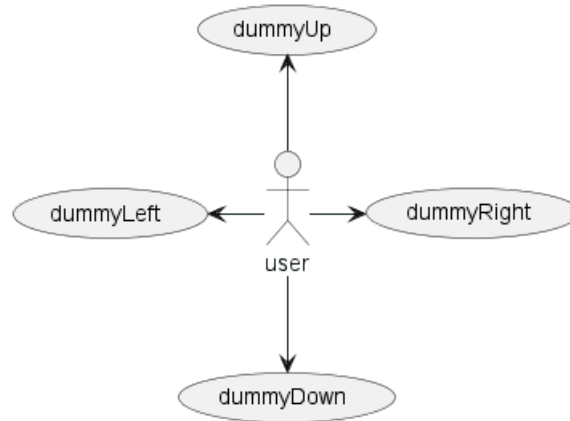

You can shorten the arrow by using only the first character of the direction (for example, `-d-` instead of `-down-`) or the two first characters (`-do-`).

Please note that you should not abuse this functionality : *Graphviz* gives usually good results without tweaking.

And with the `left to right direction` parameter:

```
@startuml
left to right direction
:user: -left-> (dummyLeft)
:user: -right-> (dummyRight)
:user: -up-> (dummyUp)
:user: -down-> (dummyDown)
@enduml
```

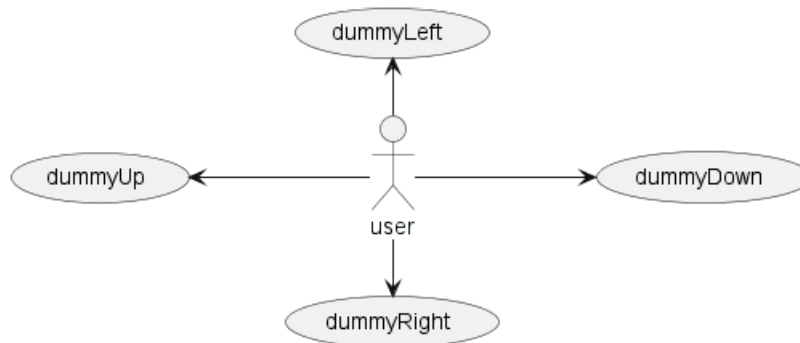

## 2.11 Splitting diagrams

The `newpage` keywords to split your diagram into several pages or images.

```
@startuml
:actor1: --> (Usecase1)
newpage
:actor2: --> (Usecase2)
@enduml
```



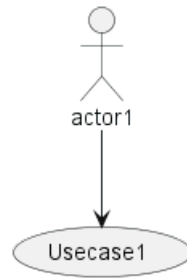

## 2.12 Left to right direction

The general default behavior when building diagram is **top to bottom**.

```

@startuml
'default
top to bottom direction
user1 --> (Usecase 1)
user2 --> (Usecase 2)
@enduml
  
```

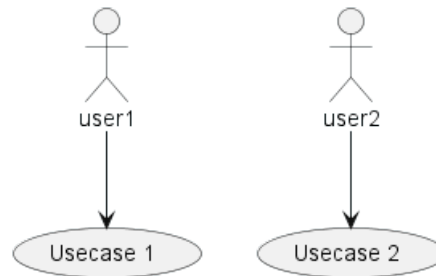

You may change to **left to right** using the `left to right direction` command. The result is often better with this direction.

```

@startuml
left to right direction
user1 --> (Usecase 1)
user2 --> (Usecase 2)
@enduml
  
```

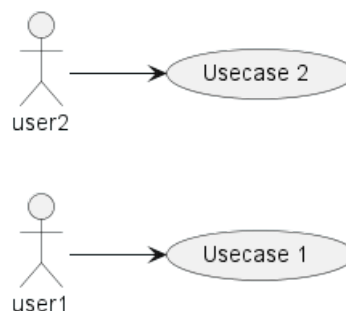

## 2.13 Skinparam

You can use the `skinparam` command to change colors and fonts for the drawing.

You can use this command :

- In the diagram definition, like any other commands,



- In an included file,
- In a configuration file, provided in the command line or the ANT task.

You can define specific color and fonts for stereotyped actors and usecases.

```
@startuml
skinparam handwritten true

skinparam usecase {
BackgroundColor DarkSeaGreen
BorderColor DarkSlateGray

BackgroundColor<< Main >> YellowGreen
BorderColor<< Main >> YellowGreen

ArrowColor Olive
ActorBorderColor black
ActorFontName Courier

ActorBackgroundColor<< Human >> Gold
}

User << Human >>
:Main Database: as MySQL << Application >>
(Start) << One Shot >>
(Use the application) as (Use) << Main >>

User -> (Start)
User --> (Use)

MySQL --> (Use)

@enduml
```

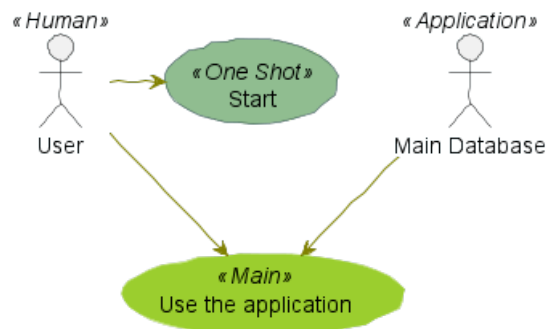

## 2.14 Complete example

```
@startuml
left to right direction
skinparam packageStyle rectangle
actor customer
actor clerk
rectangle checkout {
customer -- (checkout)
(checkout) .> (payment) : include
(help) .> (checkout) : extends
(checkout) -- clerk
}
}
```



```
@enduml
```

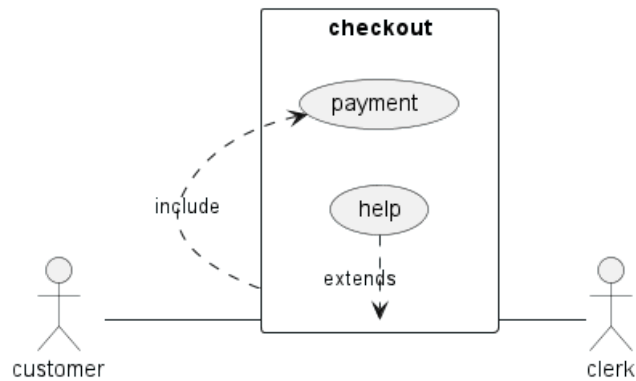

## 2.15 Business Use Case

You can add / to make Business Use Case.

### 2.15.1 Business Usecase

```
@startuml
```

```

(First usecase)/
(Another usecase)/ as UC2
usecase/ UC3
usecase/ (Last\nusecase) as UC4
  
```

```
@enduml
```

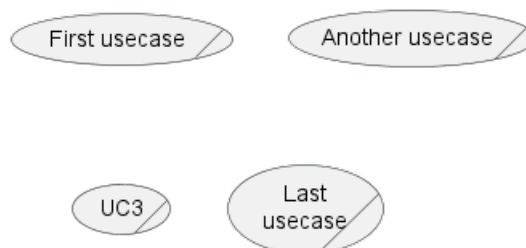

### 2.15.2 Business Actor

```
@startuml
```

```

:First Actor:/
:Another\nactor:/ as Man2
actor/ Woman3
actor/ :Last actor: as Person1
  
```

```
@enduml
```

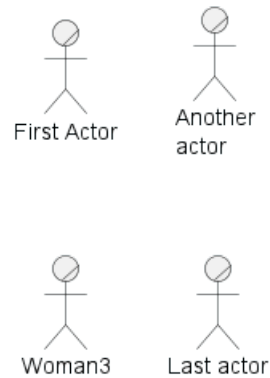

[Ref. QA-12179]

## 2.16 Change arrow color and style (inline style)

You can change the color or style of individual arrows using the inline following notation:

- `#color;line.[bold|dashed|dotted];text:color`

```
@startuml
actor foo
foo --> (bar) : normal
foo --> (bar1) #line:red;line.bold;text:red : red bold
foo --> (bar2) #green;line.dashed;text:green : green dashed
foo --> (bar3) #blue;line.dotted;text:blue : blue dotted
@enduml
```

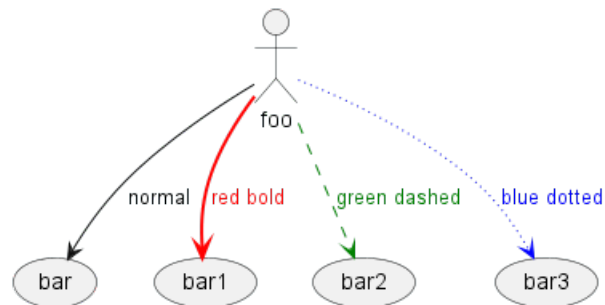

[Ref. QA-3770 and QA-3816] [See similar feature on deployment-diagram or class diagram]

## 2.17 Change element color and style (inline style)

You can change the color or style of individual element using the following notation:

- `#[color|back:color];line:color;line.[bold|dashed|dotted];text:color`

```
@startuml
actor a
actor b #pink;line:red;line.bold;text:red
usecase c #palegreen;line:green;line.dashed;text:green
usecase d #aliceblue;line:blue;line.dotted;text:blue
@enduml
```

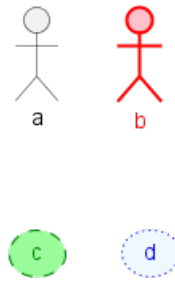

[Ref. QA-5340 and adapted from QA-6852]

## 2.18 Display JSON Data on Usecase diagram

### 2.18.1 Simple example

```
@startuml
allowmixing

actor Actor
usecase Usecase

json JSON {
  "fruit": "Apple",
  "size": "Large",
  "color": ["Red", "Green"]
}
@enduml
```



JSON	
fruit	Apple
size	Large
color	Red
	Green

[Ref. QA-15481]

For another example, see on JSON page.

### 3 Class Diagram

Class diagrams are designed using a syntax that mirrors those traditionally employed in programming languages. This resemblance fosters a familiar environment for developers, thereby facilitating an easier and more intuitive diagram creation process.

This design approach is not only succinct but also enables the creation of representations that are both concise and expressive. Moreover, it allows for the portrayal of relationships between classes through a syntax that echoes that of sequence diagrams, paving the way for a fluid and insightful depiction of class interactions.

Beyond structural and relational representations, the class diagram syntax supports further enrichments such as the inclusion of notes and the application of colors, empowering users to create diagrams that are both informative and visually appealing.

You can learn more about some of the common commands in PlantUML to enhance your diagram creation experience.

#### 3.1 Declaring element

```
@startuml
abstract      abstract
abstract class "abstract class"
annotation    annotation
circle        circle
()            circle_short_form
class         class
class         class_stereo <<stereotype>>
diamond       diamond
<>           diamond_short_form
entity        entity
enum          enum
exception     exception
interface     interface
metaclass    metaclass
protocol      protocol
stereotype    stereotype
struct        struct
@enduml
```

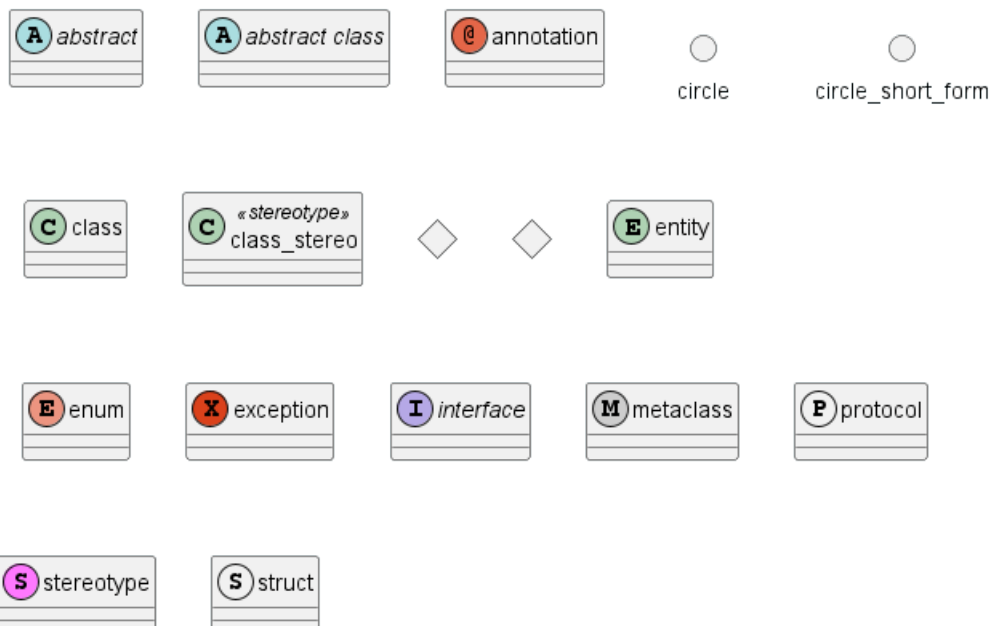

[Ref. for protocol and struct: GH-1028, for exception: QA-16258]

### 3.2 Relations between classes

Relations between classes are defined using the following symbols :

Type	Symbol	Drawing
Extension	< --	
Composition	*--	
Aggregation	o--	

It is possible to replace -- by .. to have a dotted line.

Knowing those rules, it is possible to draw the following drawings:

```
@startuml
Class01 <|-- Class02
Class03 *-- Class04
Class05 o-- Class06
Class07 .. Class08
Class09 -- Class10
@enduml
```

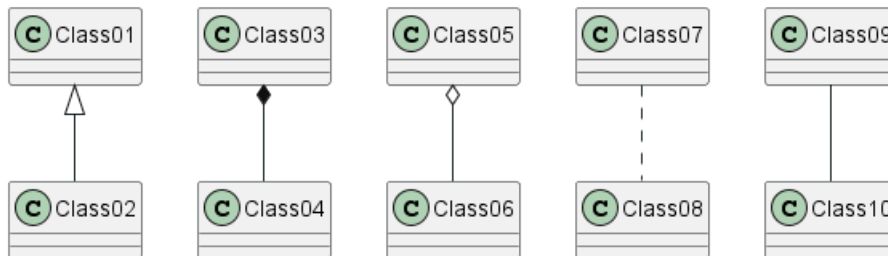

```
@startuml
Class11 <|.. Class12
Class13 --> Class14
Class15 ..> Class16
Class17 ..|> Class18
Class19 <--* Class20
@enduml
```

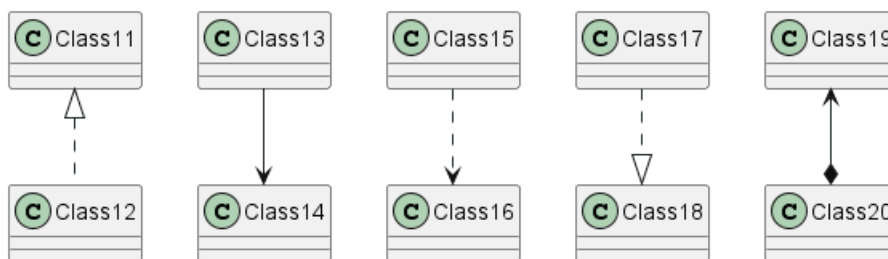

```
@startuml
Class21 #-- Class22
Class23 x-- Class24
Class25 }-- Class26
Class27 +-- Class28
Class29 ^-- Class30
@enduml
```

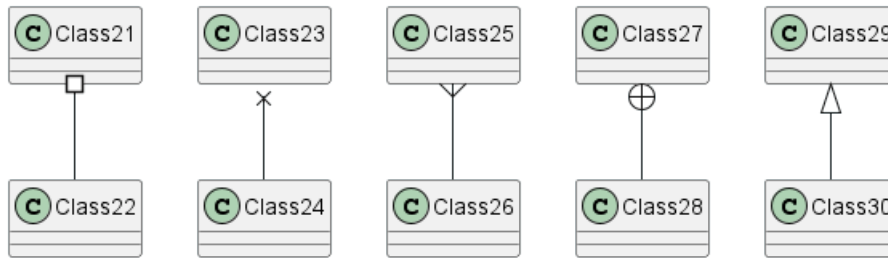

### 3.3 Label on relations

It is possible to add a label on the relation, using `:`, followed by the text of the label.

For cardinality, you can use double-quotes `"` on each side of the relation.

```
@startuml
```

```
Class01 "1" *-- "many" Class02 : contains
```

```
Class03 o-- Class04 : aggregation
```

```
Class05 --> "1" Class06
```

```
@enduml
```

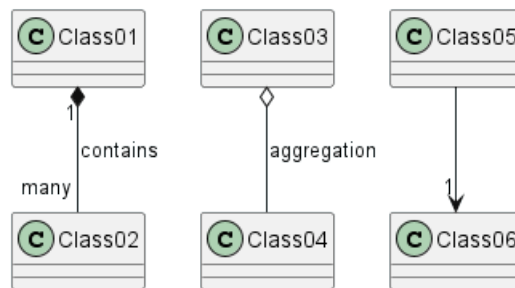

You can add an extra arrow pointing at one object showing which object acts on the other object, using `<` or `>` at the begin or at the end of the label.

```
@startuml
```

```
class Car
```

```
Driver - Car : drives >
```

```
Car *- Wheel : have 4 >
```

```
Car -- Person : < owns
```

```
@enduml
```

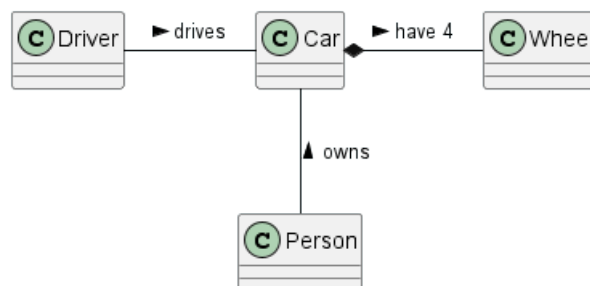

### 3.4 Using non-letters in element names and relation labels

If you want to use non-letters in the class (or enum...) display name, you can either :



- Use the `as` keyword in the class definition to assign an alias
- Put quotes `"` around the class name

```
@startuml
class "This is my class" as class1
class class2 as "It works this way too"

class2 *-- "foo/dummy" : use
@enduml
```

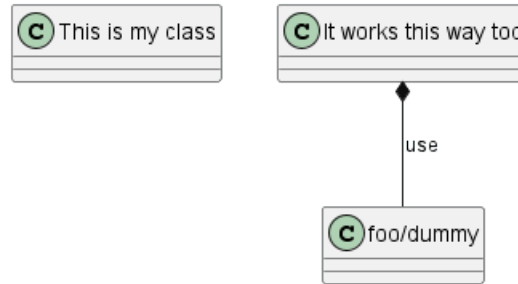

If an alias is assigned to an element, the rest of the file must refer to the element by the alias instead of the name.

### 3.4.1 Starting names with \$

Note that names starting with `$` cannot be hidden or removed later, because `hide` and `remove` command will consider the name a `$tag` instead of a component name. To later remove such elements they must have an alias or must be tagged.

```
@startuml
class $C1
class $C2 $C2
class "$C2" as dollarC2
remove $C1
remove $C2
remove dollarC2
@enduml
```



Also note that names starting with `$` are valid, but to assign an alias to such element the name must be put between quotes `"`.

## 3.5 Adding methods

To declare fields and methods, you can use the symbol `:` followed by the field's or method's name.

The system checks for parenthesis to choose between methods and fields.

```
@startuml
Object <|-- ArrayList

Object : equals()
ArrayList : Object[] elementData
ArrayList : size()

@enduml
```





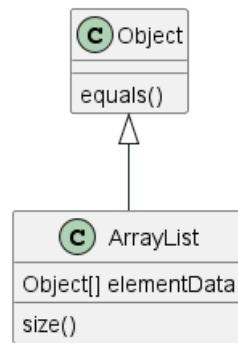

It is also possible to group between brackets {} all fields and methods.

Note that the syntax is highly flexible about type/name order.

```

@startuml
class Dummy {
    String data
    void methods()
}

class Flight {
    flightNumber : Integer
    departureTime : Date
}
@enduml
  
```



You can use {field} and {method} modifiers to override default behaviour of the parser about fields and methods.

```

@startuml
class Dummy {
    {field} A field (despite parentheses)
    {method} Some method
}
@enduml
  
```

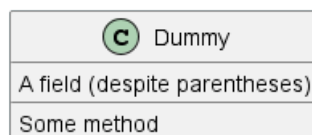

### 3.6 Defining visibility

When you define methods or fields, you can use characters to define the visibility of the corresponding item:

Character	Icon for field	Icon for method	Visibility
-	□	■	private
#	◇	◆	protected
~	△	▲	package private
+	○	●	public

```

@startuml
  
```



```
class Dummy {
  -field1
  #field2
  ~method1()
  +method2()
}

@enduml
```



You can turn off this feature using the `skinparam classAttributeIconSize 0` command :

```
@startuml
skinparam classAttributeIconSize 0
class Dummy {
  -field1
  #field2
  ~method1()
  +method2()
}

@enduml
```



Visibility indicators are optional and can be omitted individually without turning off the icons globally using `skinparam classAttributeIconSize 0`.

```
@startuml
class Dummy {
  field1
  field2
  method1()
  method2()
}

@enduml
```

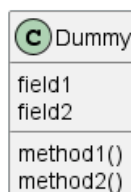

In such case if you'd like to use methods or fields that start with -, #, ~ or + characters such as a destructor in some languages for `Dummy` class (), escape the first character with a \ character:

```

@startuml
class Dummy {
  field1
  \~Dummy()
  method1()
}
@enduml

```

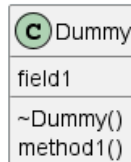

### 3.7 Abstract and Static

You can define static or abstract methods or fields using the `{static}` or `{abstract}` modifier.

These modifiers can be used at the start or at the end of the line. You can also use `{classifier}` instead of `{static}`.

```

@startuml
class Dummy {
  {static} String id
  {abstract} void methods()
}
@enduml

```

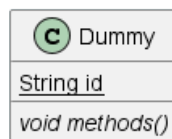

### 3.8 Advanced class body

By default, methods and fields are automatically regrouped by PlantUML. You can use separators to define your own way of ordering fields and methods. The following separators are possible : `--` `..` `==` `__`.

You can also use titles within the separators:

```

@startuml
class Foo1 {
  You can use
  several lines
  ..
  as you want
  and group
  ==
  things together.
  --
  You can have as many groups
  as you want
  --
  End of class
}

class User {
  .. Simple Getter ..
}

```



```

+ getName()
+ getAddress()
.. Some setter ..
+ setName()
__ private data __
int age
-- encrypted --
String password
}

@enduml

```

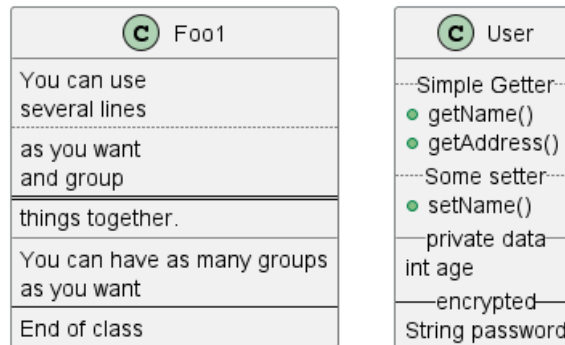

### 3.9 Notes and stereotypes

Stereotypes are defined with the `class` keyword, `<<` and `>>`.

You can also define notes using `note left of`, `note right of`, `note top of`, `note bottom of` keywords.

You can also define a note on the last defined class using `note left`, `note right`, `note top`, `note bottom`.

A note can be also define alone with the `note` keywords, then linked to other objects using the `..` symbol.

```

@startuml
class Object << general >>
Object <|--- ArrayList

```

```

note top of Object : In java, every class\nnextends this one.

```

```

note "This is a floating note" as N1
note "This note is connected\nto several objects." as N2
Object .. N2
N2 .. ArrayList

```

```

class Foo
note left: On last defined class

```

```

@enduml

```



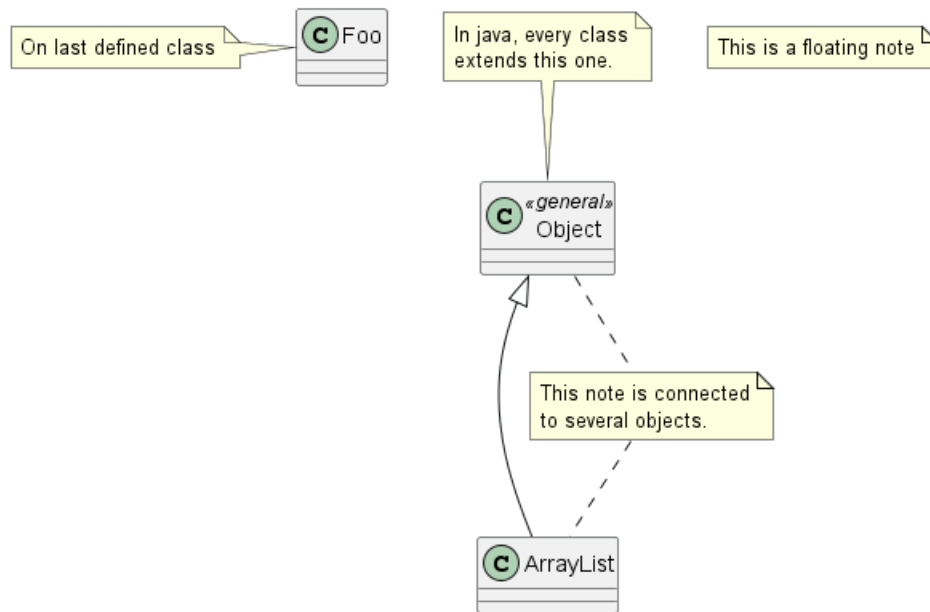

### 3.10 More on notes

It is also possible to use few HTML tags (See Creole expression) like :

- `<b>`
- `<u>`
- `<i>`
- `<s>`, `<del>`, `<strike>`
- `<font color="#AAAAAA">` or `<font color="colorName">`
- `<color:#AAAAAA>` or `<color:colorName>`
- `<size:nn>` to change font size
- `` or `<img:file>`: the file must be accessible by the filesystem

You can also have a note on several lines.

You can also define a note on the last defined class using `note left`, `note right`, `note top`, `note bottom`.

```
@startuml
```

```
class Foo
note left: On last defined class
```

```
note top of Foo
  In java, <size:18>every</size> <u>class</u>
  <b>extends</b>
  <i>this</i> one.
end note
```

```
note as N1
  This note is <u>also</u>
  <b><color:royalBlue>on several</color>
  <s>words</s> lines
  And this is hosted by <img:sourceforge.jpg>
end note
```



```
@enduml
```

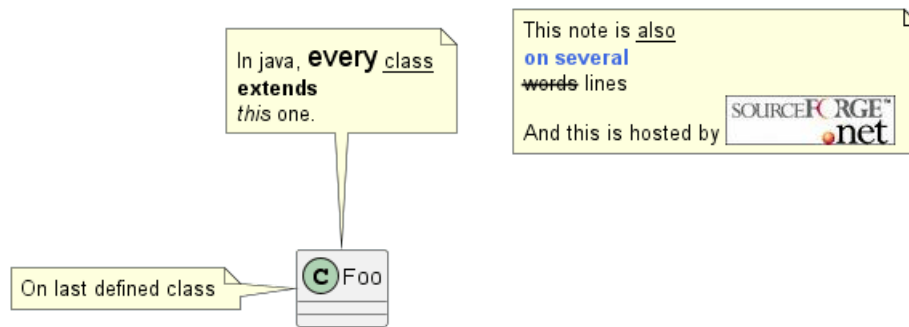

### 3.11 Note on field (field, attribute, member) or method

It is possible to add a note on field (field, attribute, member) or on method.

#### 3.11.1 Constraint

- This cannot be used with `top` or `bottom` (*only left and right are implemented*)
- This cannot be used with namespaceSeparator `::`

#### 3.11.2 Note on field or method

```
@startuml
class A {
{static} int counter
+void {abstract} start(int timeout)
}
note right of A::counter
  This member is annotated
end note
note right of A::start
  This method is now explained in a UML note
end note
@enduml
```

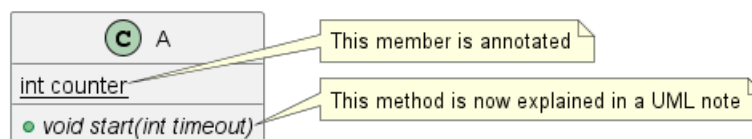

#### 3.11.3 Note on method with the same name

```
@startuml
class A {
{static} int counter
+void {abstract} start(int timeoutms)
+void {abstract} start(Duration timeout)
}
note left of A::counter
  This member is annotated
end note
note right of A::"start(int timeoutms)"
  This method with int
end note
note right of A::"start(Duration timeout)"
  This method with Duration
enduml
```



```
end note
@enduml
```

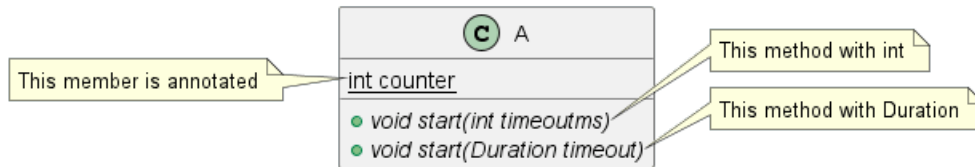

[Ref. QA-3474 and QA-5835]

### 3.12 Note on links

It is possible to add a note on a link, just after the link definition, using `note on link`.

You can also use `note left on link`, `note right on link`, `note top on link`, `note bottom on link` if you want to change the relative position of the note with the label.

```
@startuml
```

```
class Dummy
Dummy --> Foo : A link
note on link #red: note that is red
```

```
Dummy --> Foo2 : Another link
note right on link #blue
this is my note on right link
and in blue
end note
```

```
@enduml
```

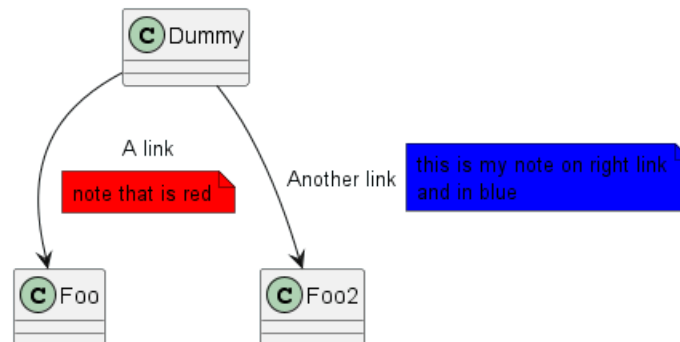

### 3.13 Abstract class and interface

You can declare a class as abstract using `abstract` or `abstract class` keywords.

The class will be printed in *italic*.

You can use the `interface`, `annotation` and `enum` keywords too.

```
@startuml
```

```
abstract class AbstractList
abstract AbstractCollection
interface List
interface Collection
```

```
List <|-- AbstractList
Collection <|-- AbstractCollection
```



```

Collection <|-- List
AbstractCollection <|-- AbstractList
ArrayList <|-- ArrayList

class ArrayList {
    Object[] elementData
    size()
}

enum TimeUnit {
    DAYS
    HOURS
    MINUTES
}

annotation SuppressWarnings

annotation Annotation {
    annotation with members
    String foo()
    String bar()
}

@enduml

```

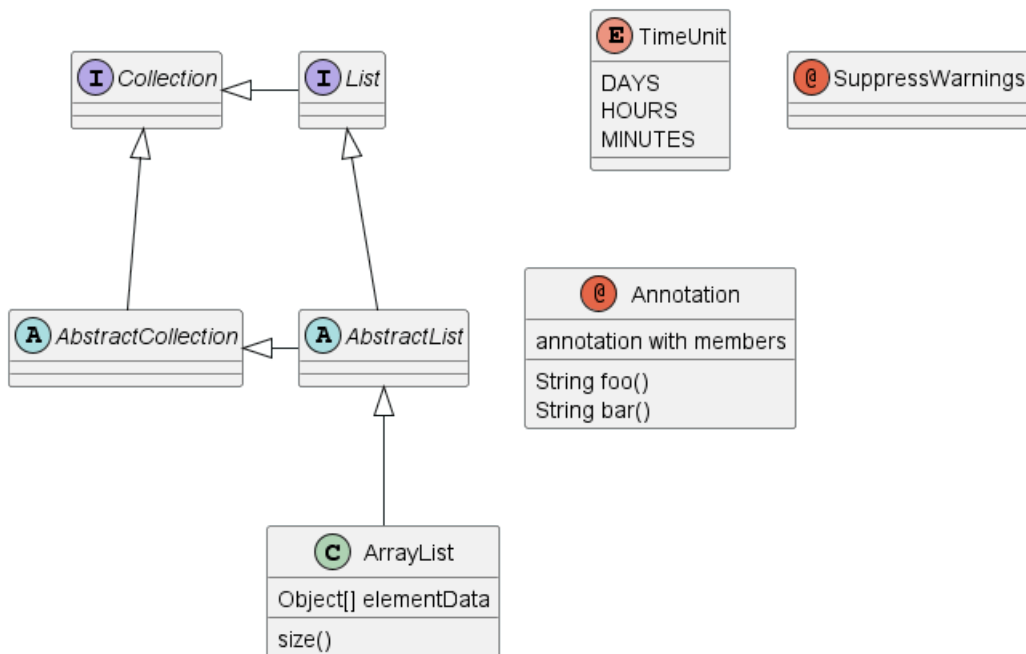

[Ref. 'Annotation with members' Issue#458]

### 3.14 Hide attributes, methods...

You can parameterize the display of classes using the `hide/show` command.

The basic command is: `hide empty members`. This command will hide attributes or methods if they are empty.

Instead of `empty members`, you can use:

- `empty fields` or `empty attributes` for empty fields,





- `empty methods` for empty methods,
- `fields` or `attributes` which will hide fields, even if they are described,
- `methods` which will hide methods, even if they are described,
- `members` which will hide fields and methods, even if they are described,
- `circle` for the circled character in front of class name,
- `stereotype` for the stereotype.

You can also provide, just after the `hide` or `show` keyword:

- `class` for all classes,
- `interface` for all interfaces,
- `enum` for all enums,
- `<<foo1>>` for classes which are stereotyped with `foo1`,
- an existing class name.

You can use several `show/hide` commands to define rules and exceptions.

```
@startuml
```

```
class Dummy1 {
  +myMethods()
}
```

```
class Dummy2 {
  +hiddenMethod()
}
```

```
class Dummy3 <<Serializable>> {
  String name
}
```

```
hide members
```

```
hide <<Serializable>> circle
```

```
show Dummy1 methods
```

```
show <<Serializable>> fields
```

```
@enduml
```

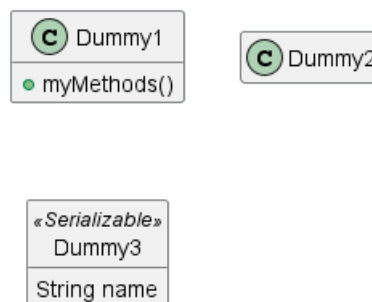

### 3.15 Hide classes

You can also use the `show/hide` commands to hide classes.

This may be useful if you define a large included file, and if you want to hide some classes after file inclusion.



```

@startuml

class Foo1
class Foo2

Foo2 *-- Foo1

hide Foo2

@enduml

```



### 3.16 Remove classes

You can also use the `remove` commands to remove classes.

This may be useful if you define a large !included file, and if you want to remove some classes after file inclusion.

```

@startuml

class Foo1
class Foo2

Foo2 *-- Foo1

remove Foo2

@enduml

```



### 3.17 Hide, Remove or Restore tagged element or wildcard

You can put `$tags` (using `$`) on elements, then remove, hide or restore components either individually or by tags.

By default, all components are displayed:

```

@startuml
class C1 $tag13
enum E1
interface I1 $tag13
C1 -- I1
@enduml

```

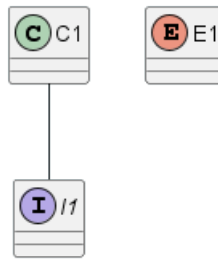

But you can:

- hide \$tag13 components:

```

@startuml
class C1 $tag13
enum E1
interface I1 $tag13
C1 -- I1
  
```

```

hide $tag13
@enduml
  
```



- or remove \$tag13 components:

```

@startuml
class C1 $tag13
enum E1
interface I1 $tag13
C1 -- I1
  
```

```

remove $tag13
@enduml
  
```



- or remove \$tag13 and restore \$tag1 components:

```

@startuml
class C1 $tag13 $tag1
enum E1
interface I1 $tag13
C1 -- I1
  
```

```

remove $tag13
restore $tag1
@enduml
  
```



- or remove \* and restore \$tag1 components:

```
@startuml
class C1 $tag13 $tag1
enum E1
interface I1 $tag13
C1 -- I1

remove *
restore $tag1
@enduml
```

### 3.18 Hide or Remove unlinked class

By default, all classes are displayed:

```
@startuml
class C1
class C2
class C3
C1 -- C2
@enduml
```

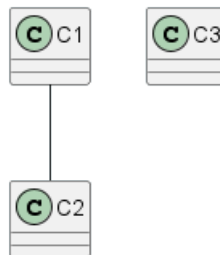

But you can:

- hide @unlinked classes:

```
@startuml
class C1
class C2
class C3
C1 -- C2

hide @unlinked
@enduml
```



- or remove @unlinked classes:

```
@startuml
class C1
class C2
class C3
```



```
C1 -- C2
```

```
remove @unlinked
@enduml
```



[Adapted from QA-11052]

### 3.19 Use generics

You can also use bracket < and > to define generics usage in a class.

```
@startuml
class Foo<? extends Element> {
    int size()
}
Foo *- Element
@enduml
```

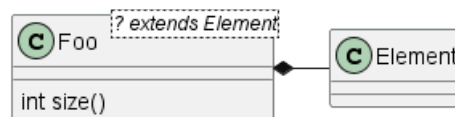

It is possible to disable this drawing using `skinparam genericDisplay old` command.

### 3.20 Specific Spot

Usually, a spotted character (C, I, E or A) is used for classes, interface, enum and abstract classes.

But you can define your own spot for a class when you define the stereotype, adding a single character and a color, like in this example:

```
@startuml
class System << (S,#FF7700) Singleton >>
class Date << (D,orchid) >>
@enduml
```

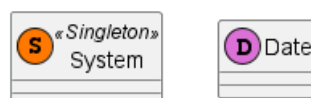

### 3.21 Packages

You can define a package using the `package` keyword, and optionally declare a background color for your package (Using a html color code or name).

Note that package definitions can be nested.

```
@startuml
```



```

package "Classic Collections" #DDDDDD {
    Object <|-- ArrayList
}

package com.plantum1 {
    Object <|-- Demo1
    Demo1 *- Demo2
}

@enduml

```

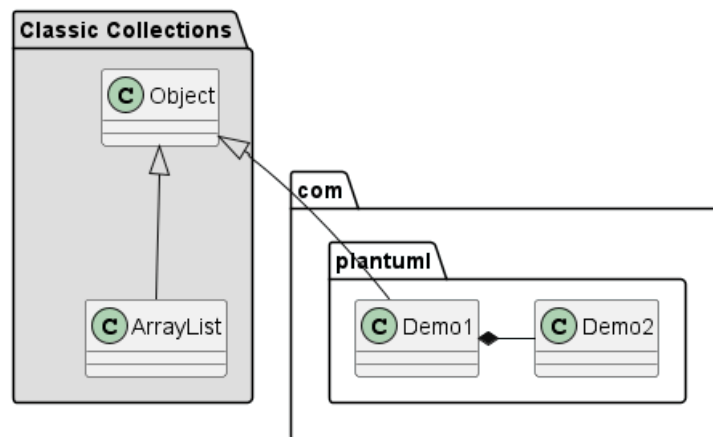

### 3.22 Packages style

There are different styles available for packages.

You can specify them either by setting a default style with the command : `skinparam packageStyle`, or by using a stereotype on the package:

```

@startuml
scale 750 width
package foo1 <<Node>> {
    class Class1
}

package foo2 <<Rectangle>> {
    class Class2
}

package foo3 <<Folder>> {
    class Class3
}

package foo4 <<Frame>> {
    class Class4
}

package foo5 <<Cloud>> {
    class Class5
}

package foo6 <<Database>> {
    class Class6
}

@enduml

```





You can also define links between packages, like in the following example:

```
@startuml
skinparam packageStyle rectangle

package foo1.foo2 {
}

package foo1.foo2.foo3 {
    class Object
}

foo1.foo2 +-- foo1.foo2.foo3

@enduml
```

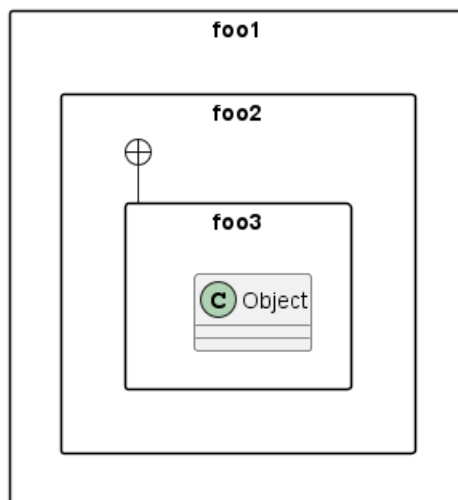

### 3.23 Namespaces

Starting with version 1.2023.2 (which is online as a beta), PlantUML handles differently namespaces and packages.

There won't be any difference between namespaces and packages anymore: both keywords are now synonymous.

### 3.24 Automatic package creation

You can define another separator (other than the dot) using the command : `set separator ???`.

```
@startuml

set separator ::
class X1::X2::foo {
    some info
}
```



```
@enduml
```

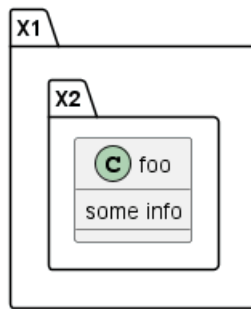

You can disable automatic namespace creation using the command `set separator none`.

```
@startuml
```

```
set separator none
class X1.X2.foo {
    some info
}
```

```
@enduml
```

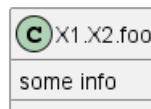

### 3.25 Lollipop interface

You can also define lollipop interface on classes, using the following syntax:

- `bar ()- foo`
- `bar ()-- foo`
- `foo -() bar`

```
@startuml
class foo
bar ()- foo
@enduml
```



### 3.26 Changing arrows orientation

By default, links between classes have two dashes `--` and are vertically oriented. It is possible to use horizontal link by putting a single dash (or dot) like this:

```
@startuml
Room o- Student
Room *-- Chair
@enduml
```



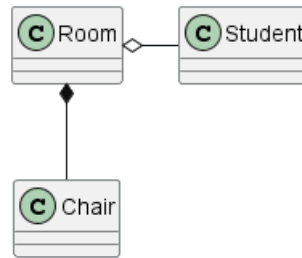

You can also change directions by reversing the link:

```
@startuml
Student -o Room
Chair --* Room
@enduml
```

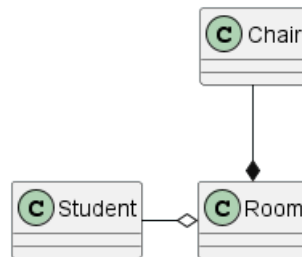

It is also possible to change arrow direction by adding `left`, `right`, `up` or `down` keywords inside the arrow:

```
@startuml
foo -left-> dummyLeft
foo -right-> dummyRight
foo -up-> dummyUp
foo -down-> dummyDown
@enduml
```

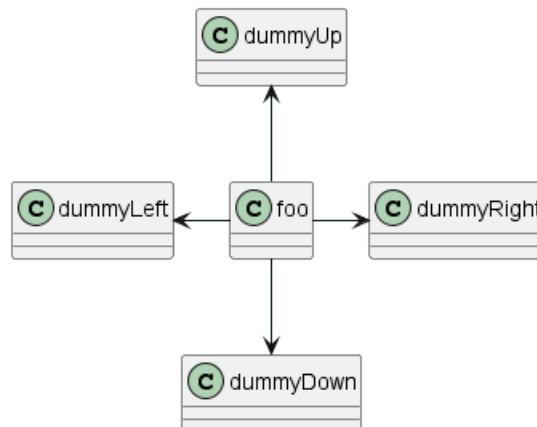

You can shorten the arrow by using only the first character of the direction (for example, `-d-` instead of `-down-`) or the two first characters (`-do-`).

Please note that you should not abuse this functionality : *Graphviz* gives usually good results without tweaking.

And with the `left to right direction` parameter:

```
@startuml
left to right direction
foo -left-> dummyLeft
foo -right-> dummyRight
foo -up-> dummyUp
@enduml
```



```
foo -down-> dummyDown
@enduml
```

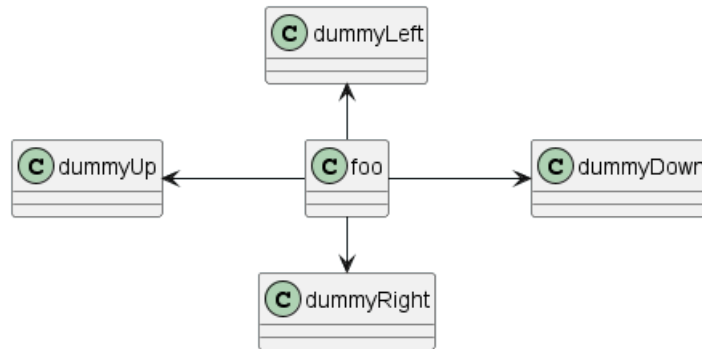

### 3.27 Association classes

You can define *association class* after that a relation has been defined between two classes, like in this example:

```
@startuml
class Student {
    Name
}
Student "0..*" -- "1..*" Course
(Student, Course) .. Enrollment

class Enrollment {
    drop()
    cancel()
}
@enduml
```

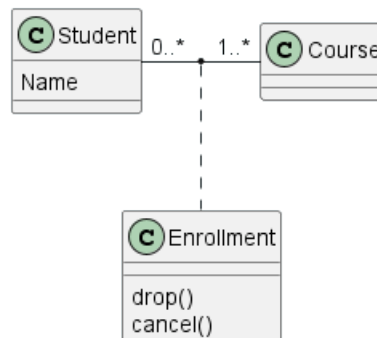

You can define it in another direction:

```
@startuml
class Student {
    Name
}
Student "0..*" -- "1..*" Course
(Student, Course) . Enrollment

class Enrollment {
    drop()
    cancel()
}
@enduml
```

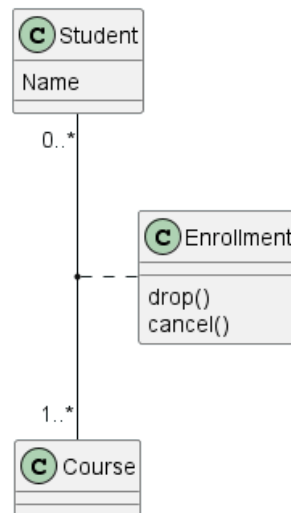

### 3.28 Association on same class

```

@startuml
class Station {
    +name: string
}

class StationCrossing {
    +cost: TimeInterval
}

<> diamond

StationCrossing . diamond
diamond - "from 0..*" Station
diamond - "to 0..*" Station
@enduml
  
```

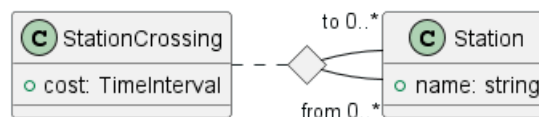

[Ref. Incubation: Associations]

### 3.29 Skinparam

You can use the skinparam command to change colors and fonts for the drawing.

You can use this command :

- In the diagram definition, like any other commands,
- In an included file,
- In a configuration file, provided in the command line or the ANT task.

```

@startuml

skinparam class {
BackgroundColor PaleGreen
ArrowColor SeaGreen
BorderColor SpringGreen
}
  
```



```

skinparam stereotypeCBackgroundColor YellowGreen

Class01 "1" *-- "many" Class02 : contains

Class03 o-- Class04 : aggregation

@enduml

```

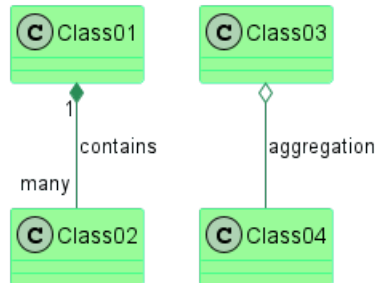

### 3.30 Skinned Stereotypes

You can define specific color and fonts for stereotyped classes.

```

@startuml

skinparam class {
  BackgroundColor PaleGreen
  ArrowColor SeaGreen
  BorderColor SpringGreen
  BackgroundColor<<Foo>> Wheat
  BorderColor<<Foo>> Tomato
}

skinparam stereotypeCBackgroundColor YellowGreen
skinparam stereotypeCBackgroundColor<< Foo >> DimGray

class Class01 <<Foo>>
class Class03 <<Foo>>
Class01 "1" *-- "many" Class02 : contains

Class03 o-- Class04 : aggregation

@enduml

```

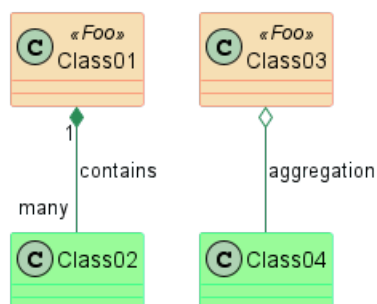

### 3.31 Color gradient

You can declare individual colors for classes, notes etc using the # notation.

You can use standard color names or RGB codes in various notations, see Colors.

You can also use color gradient for background colors, with the following syntax: two colors names separated either by:



- |,
- /,
- \, or
- -

depending on the direction of the gradient.

For example:

```
@startuml
skinparam backgroundColor AntiqueWhite/Gold
skinparam classBackgroundColor Wheat|CornflowerBlue

class Foo #red-green
note left of Foo #blue\9932CC
  this is my
  note on this class
end note

package example #GreenYellow/LightGoldenRodYellow {
  class Dummy
}

@enduml
```

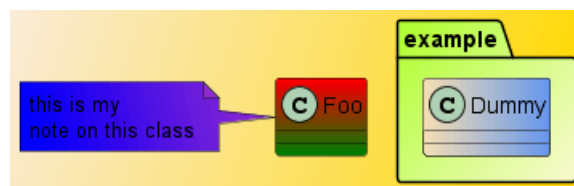

### 3.32 Help on layout

Sometimes, the default layout is not perfect...

You can use `together` keyword to group some classes together : the layout engine will try to group them (as if they were in the same package).

You can also use `hidden` links to force the layout.

```
@startuml
class Bar1
class Bar2
together {
  class Together1
  class Together2
  class Together3
}
Together1 - Together2
Together2 - Together3
Together2 -[hidden]--> Bar1
Bar1 -[hidden]> Bar2

@enduml
```

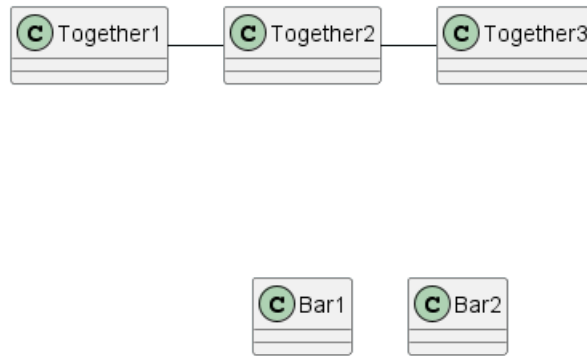

### 3.33 Splitting large files

Sometimes, you will get some very large image files.

You can use the `page (hpages)x(vpages)` command to split the generated image into several files :

`hpages` is a number that indicated the number of horizontal pages, and `vpages` is a number that indicated the number of vertical pages.

You can also use some specific `skinparam` settings to put borders on splitted pages (see example).

```

@startuml
' Split into 4 pages
page 2x2
skinparam pageMargin 10
skinparam pageExternalColor gray
skinparam pageBorderColor black

class BaseClass

namespace net.dummy #DDDDDD {
  .BaseClass <|-- Person
  Meeting o-- Person

  .BaseClass <|-- Meeting
}

namespace net.foo {
  net.dummy.Person <|-- Person
  .BaseClass <|-- Person

  net.dummy.Meeting o-- Person
}

BaseClass <|-- net.unused.Person
@enduml

```

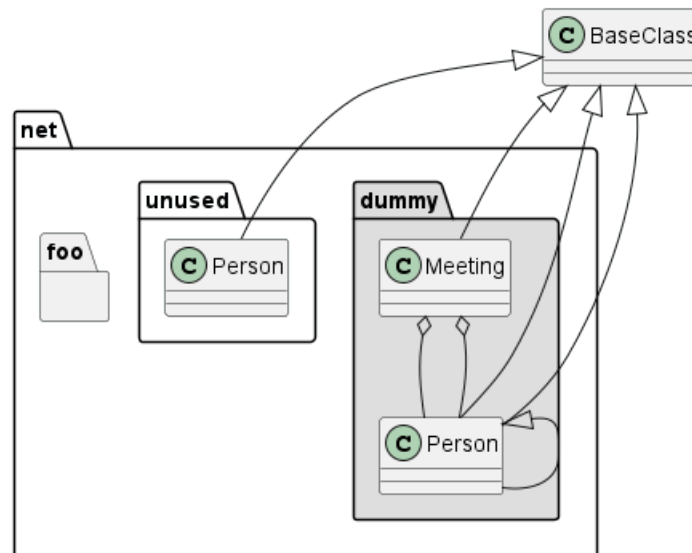

### 3.34 Extends and implements

It is also possible to use `extends` and `implements` keywords.

```

@startuml
class ArrayList implements List
class ArrayList extends AbstractList
@enduml
  
```

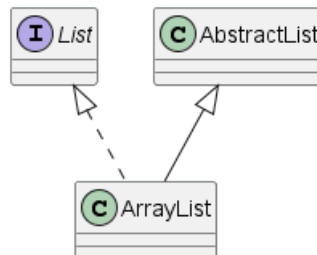

### 3.35 Bracketed relations (linking or arrow) style

#### 3.35.1 Line style

It's also possible to have explicitly `bold`, `dashed`, `dotted`, `hidden` or `plain` relation, links or arrows:

- without label

```

@startuml
title Bracketed line style without label
class foo
class bar
bar1 : [bold]
bar2 : [dashed]
bar3 : [dotted]
bar4 : [hidden]
bar5 : [plain]

foo --> bar
foo -[bold]-> bar1
foo -[dashed]-> bar2
foo -[dotted]-> bar3
  
```

```
foo -[hidden]-> bar4
foo -[plain]-> bar5
@enduml
```

Bracketed line style without label

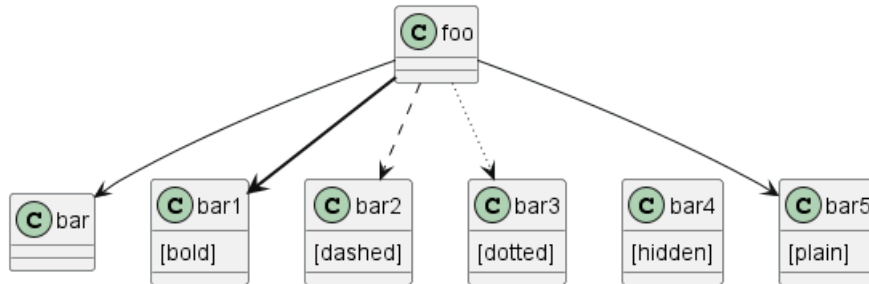

- with label

```
@startuml
title Bracketed line style with label
class foo
class bar
bar1 : [bold]
bar2 : [dashed]
bar3 : [dotted]
bar4 : [hidden]
bar5 : [plain]

foo --> bar :
foo -[bold]-> bar1 : [bold]
foo -[dashed]-> bar2 : [dashed]
foo -[dotted]-> bar3 : [dotted]
foo -[hidden]-> bar4 : [hidden]
foo -[plain]-> bar5 : [plain]
@enduml
```

Bracketed line style with label

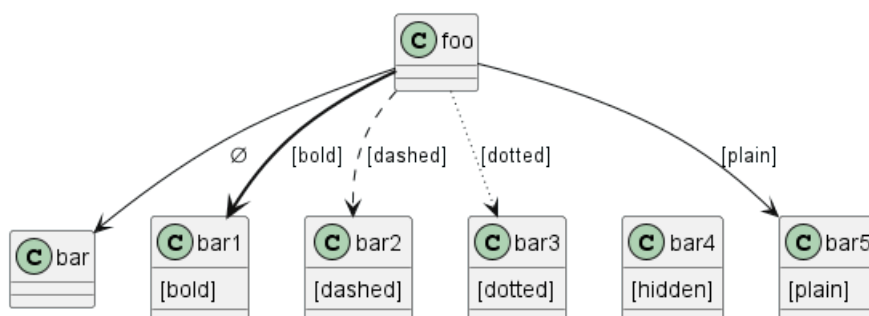

[Adapted from QA-4181]

### 3.35.2 Line color

```
@startuml
title Bracketed line color
class foo
class bar
bar1 : [#red]
bar2 : [#green]
```





```

bar3 : [#blue]

foo --> bar
foo -[#red]-> bar1 : [#red]
foo -[#green]-> bar2 : [#green]
foo -[#blue]-> bar3 : [#blue]
'foo -[#blue;#yellow;#green]-> bar4
@enduml

```

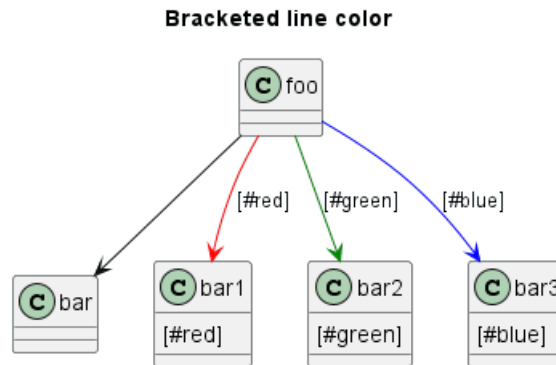

### 3.35.3 Line thickness

```

@startuml
title Bracketed line thickness
class foo
class bar
bar1 : [thickness=1]
bar2 : [thickness=2]
bar3 : [thickness=4]
bar4 : [thickness=8]
bar5 : [thickness=16]

foo --> bar :
foo -[thickness=1]-> bar1 : [1]
foo -[thickness=2]-> bar2 : [2]
foo -[thickness=4]-> bar3 : [4]
foo -[thickness=8]-> bar4 : [8]
foo -[thickness=16]-> bar5 : [16]

@enduml

```

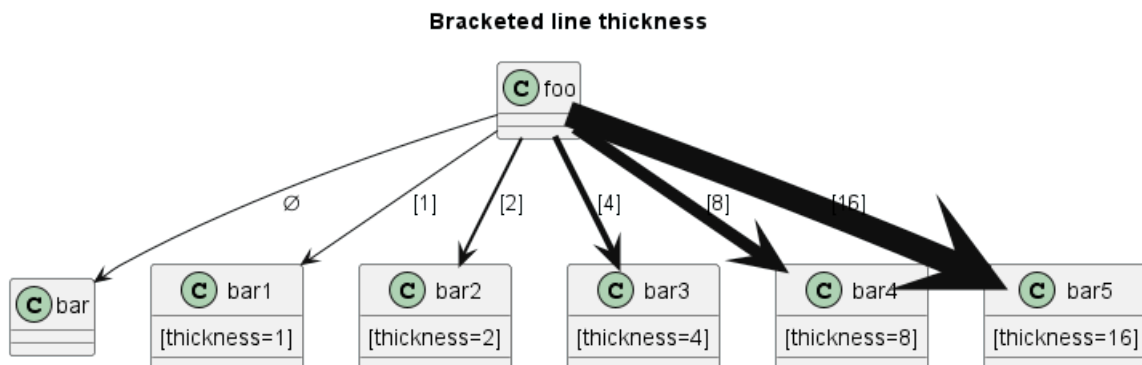

[Ref. QA-4949]

## 3.35.4 Mix

```

@startuml
title Bracketed line style mix
class foo
class bar
bar1 : [#red,thickness=1]
bar2 : [#red,dashed,thickness=2]
bar3 : [#green,dashed,thickness=4]
bar4 : [#blue,dotted,thickness=8]
bar5 : [#blue,plain,thickness=16]

foo --> bar
foo -[#red,thickness=1]-> bar1 : [#red,1]
foo -[#red,dashed,thickness=2]-> bar2 : [#red,dashed,2]
foo -[#green,dashed,thickness=4]-> bar3 : [#green,dashed,4]
foo -[#blue,dotted,thickness=8]-> bar4 : [blue,dotted,8]
foo -[#blue,plain,thickness=16]-> bar5 : [blue,plain,16]
@enduml

```

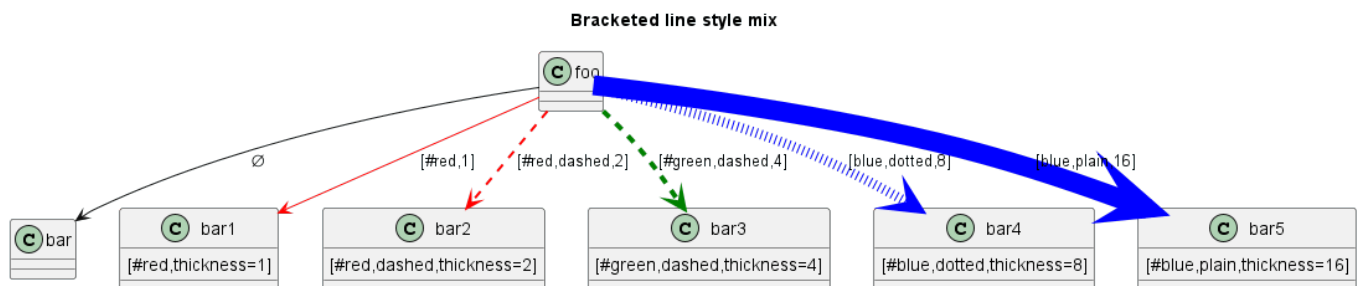

## 3.36 Change relation (linking or arrow) color and style (inline style)

You can change the color or style of individual relation or arrows using the inline following notation:

- `#color;line.[bold|dashed|dotted];text:color`

```

@startuml
class foo
foo --> bar : normal
foo --> bar1 #line:red;line.bold;text:red : red bold
foo --> bar2 #green;line.dashed;text:green : green dashed
foo --> bar3 #blue;line.dotted;text:blue : blue dotted
@enduml

```

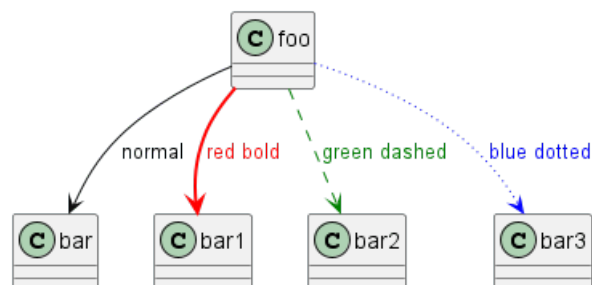

*[See similar feature on deployment]*

## 3.37 Change class color and style (inline style)

You can change the color or style of individual class using the two following notations:



- #color ##[style]color

With background color first (#color), then line style and line color (##[style]color )

```
@startuml
abstract    abstract
annotation  annotation #pink ##[bold]red
class       class      #palegreen ##[dashed]green
interface   interface  #aliceblue ##[dotted]blue
@enduml
```

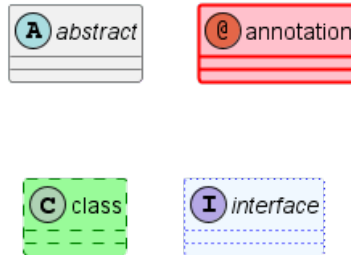

[Ref. QA-1487]

- #[color|back:color];header:color;line:color;line.[bold|dashed|dotted];text:color

```
@startuml
abstract    abstract
annotation  annotation #pink;line:red;line.bold;text:red
class       class      #palegreen;line:green;line.dashed;text:green
interface   interface  #aliceblue;line:blue;line.dotted;text:blue
@enduml
```

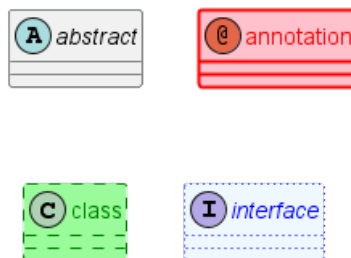

First original example:

```
@startuml
class bar #line:green;back:lightblue
class bar2 #lightblue;line:green

class Foo1 #back:red;line:00FFFF
class FooDashed #line.dashed:blue
class FooDotted #line.dotted:blue
class FooBold #line.bold
class Demo1 #back:lightgreen|yellow;header:blue/red
@enduml
```

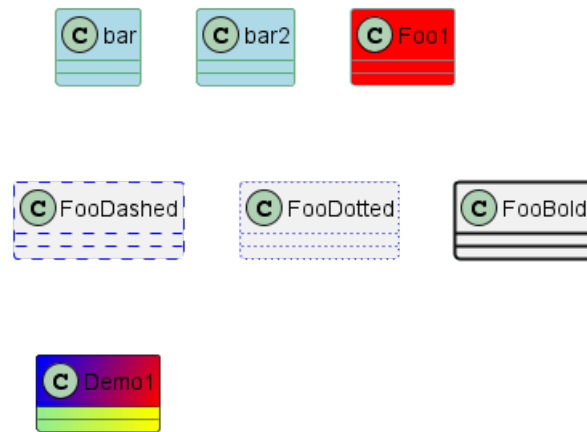

[Ref. QA-3770]

### 3.38 Arrows from/to class members

```
@startuml
class Foo {
+ field1
+ field2
}

class Bar {
+ field3
+ field4
}

Foo::field1 --> Bar::field3 : foo
Foo::field2 --> Bar::field4 : bar
@enduml
```

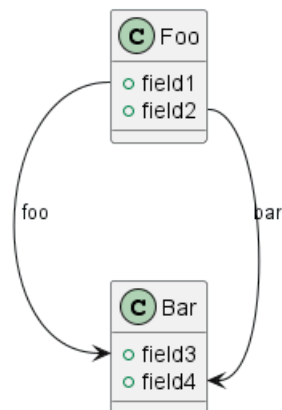

[Ref. QA-3636]

```
@startuml
left to right direction

class User {
  id : INTEGER
  ..
  other_id : INTEGER
}

class Email {
```



```

id : INTEGER
..
user_id : INTEGER
address : INTEGER
}

User::id *-- Email::user_id
@enduml

```

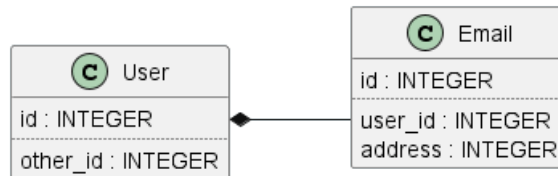

[Ref. QA-5261]

### 3.39 Grouping inheritance arrow heads

You can merge all arrow heads using the skinparam `groupInheritance`, with a threshold as parameter.

#### 3.39.1 GroupInheritance 1 (no grouping)

```

@startuml
skinparam groupInheritance 1

A1 <|-- B1

A2 <|-- B2
A2 <|-- C2

A3 <|-- B3
A3 <|-- C3
A3 <|-- D3

A4 <|-- B4
A4 <|-- C4
A4 <|-- D4
A4 <|-- E4
@enduml

```

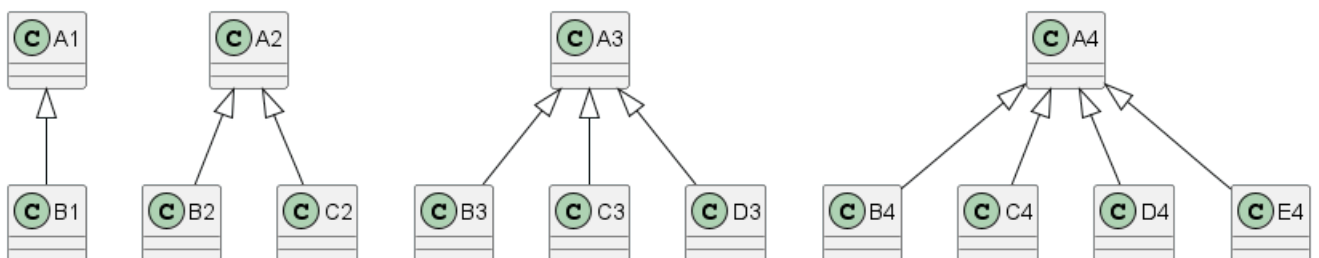

#### 3.39.2 GroupInheritance 2 (grouping from 2)

```

@startuml
skinparam groupInheritance 2

A1 <|-- B1

A2 <|-- B2

```



```
A2 <|-- C2
```

```
A3 <|-- B3
```

```
A3 <|-- C3
```

```
A3 <|-- D3
```

```
A4 <|-- B4
```

```
A4 <|-- C4
```

```
A4 <|-- D4
```

```
A4 <|-- E4
```

```
@enduml
```

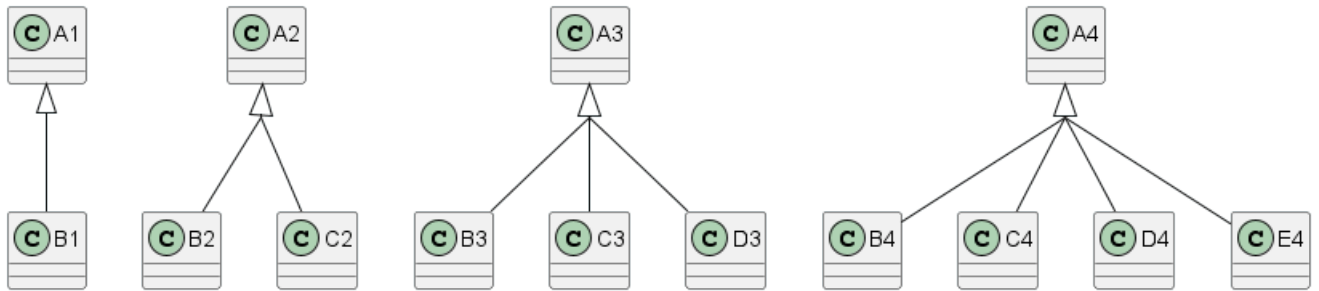

### 3.39.3 GroupInheritance 3 (grouping only from 3)

```
@startuml
```

```
skinparam groupInheritance 3
```

```
A1 <|-- B1
```

```
A2 <|-- B2
```

```
A2 <|-- C2
```

```
A3 <|-- B3
```

```
A3 <|-- C3
```

```
A3 <|-- D3
```

```
A4 <|-- B4
```

```
A4 <|-- C4
```

```
A4 <|-- D4
```

```
A4 <|-- E4
```

```
@enduml
```

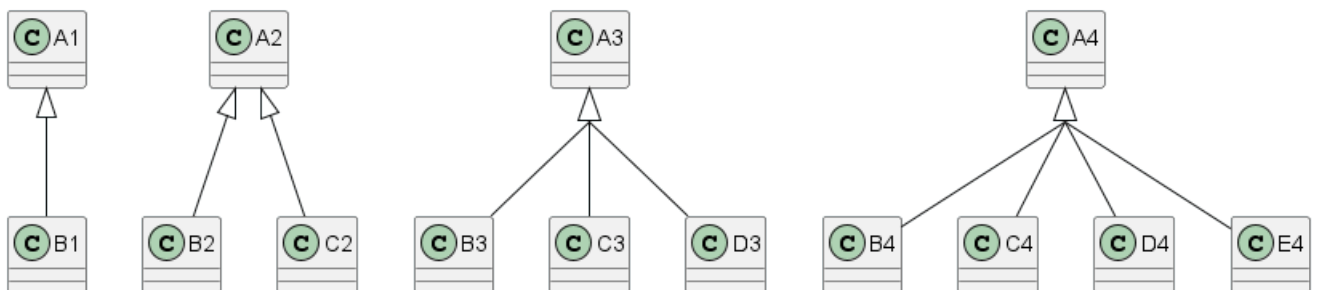

### 3.39.4 GroupInheritance 4 (grouping only from 4)

```
@startuml
```

```
skinparam groupInheritance 4
```

```

A1 <|-- B1

A2 <|-- B2
A2 <|-- C2

A3 <|-- B3
A3 <|-- C3
A3 <|-- D3

A4 <|-- B4
A4 <|-- C4
A4 <|-- D4
A4 <|-- E4
@enduml

```

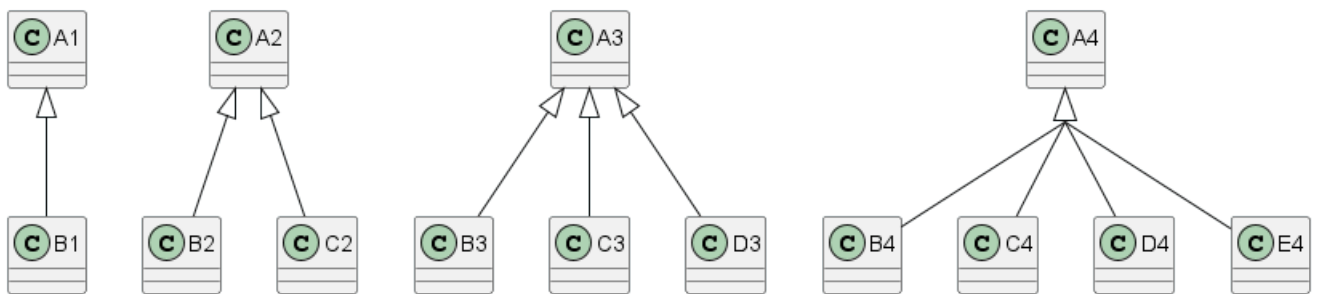

[Ref. QA-3193, and Defect QA-13532]

### 3.40 Display JSON Data on Class or Object diagram

#### 3.40.1 Simple example

```

@startuml
class Class
object Object
json JSON {
    "fruit": "Apple",
    "size": "Large",
    "color": ["Red", "Green"]
}
@enduml

```

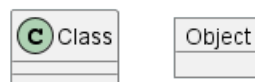

JSON	
fruit	Apple
size	Large
color	Red
	Green

[Ref. QA-15481]

For another example, see on JSON page.

### 3.41 Packages and Namespaces Enhancement

[From V1.2023.2+, and V1.2023.5]

```
@startuml
class A.B.C.D.Z {
}
@enduml
```

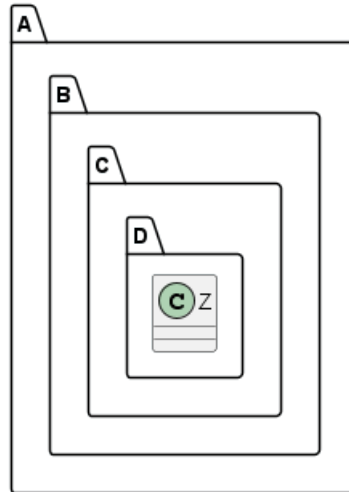

```
@startuml
set separator none
class A.B.C.D.Z {
}
@enduml
```



```
@startuml
!pragma useIntermediatePackages false
class A.B.C.D.Z {
}
@enduml
```

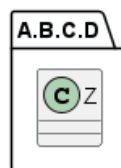

```
@startuml
set separator none
package A.B.C.D {
  class Z {
  }
}
@enduml
```

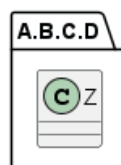



[Ref. GH-1352]



## 4 Object Diagram

An **object diagram** is a graphical representation that showcases objects and their relationships at a specific moment in time. It provides a snapshot of the system's structure, capturing the static view of the instances present and their associations.

**PlantUML** offers a simple and intuitive way to create object diagrams using plain text. Its user-friendly syntax allows for quick diagram creation without the need for complex GUI tools. Moreover, the PlantUML forum provides a platform for users to discuss, share, and seek assistance, fostering a collaborative community. By choosing PlantUML, users benefit from both the efficiency of markdown-based diagramming and the support of an active community.

### 4.1 Definition of objects

You define instances of objects using the `object` keyword.

```
@startuml
object firstObject
object "My Second Object" as o2
@enduml
```

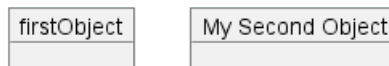

### 4.2 Relations between objects

Relations between objects are defined using the following symbols :

Type	Symbol	Image
Extension	< --	
Composition	*--	
Aggregation	o--	

It is possible to replace `--` by `..` to have a dotted line.

Knowing those rules, it is possible to draw the following drawings.

It is possible to add a label on the relation, using `:` followed by the text of the label.

For cardinality, you can use double-quotes `"` on each side of the relation.

```
@startuml
object Object01
object Object02
object Object03
object Object04
object Object05
object Object06
object Object07
object Object08

Object01 <|-- Object02
Object03 *-- Object04
Object05 o-- "4" Object06
Object07 .. Object08 : some labels
@enduml
```



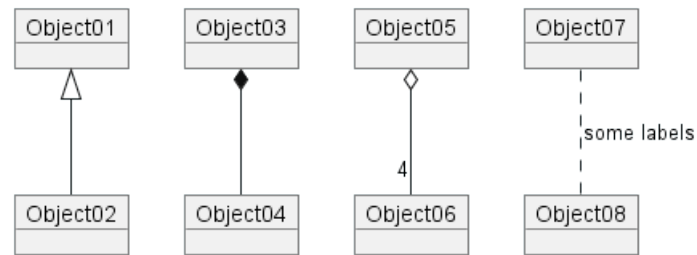

### 4.3 Associations objects

```

@startuml
object o1
object o2
diamond dia
object o3

o1 --> dia
o2 --> dia
dia --> o3
@enduml
  
```



### 4.4 Adding fields

To declare fields, you can use the symbol `:` followed by the field's name.

```

@startuml

object user

user : name = "Dummy"
user : id = 123

@enduml
  
```

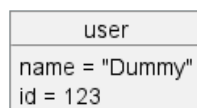

It is also possible to group all fields between brackets `{}`.

```

@startuml

object user {
  name = "Dummy"
  id = 123
}

@enduml
  
```



```
@enduml
```

user
name = "Dummy"
id = 123

## 4.5 Common features with class diagrams

- Hide attributes, methods...
- Defines notes
- Use packages
- Skin the output

## 4.6 Map table or associative array

You can define a map table or associative array, with `map` keyword and `=>` separator.

```
@startuml
map CapitalCity {
  UK => London
  USA => Washington
  Germany => Berlin
}
@enduml
```

CapitalCity	
UK	London
USA	Washington
Germany	Berlin

```
@startuml
map "Map **Contry => CapitalCity**" as CC {
  UK => London
  USA => Washington
  Germany => Berlin
}
@enduml
```

Map <b>Contry =&gt; CapitalCity</b>	
UK	London
USA	Washington
Germany	Berlin

```
@startuml
map "map: Map<Integer, String>" as users {
  1 => Alice
  2 => Bob
  3 => Charlie
}
@enduml
```

map: Map<Integer, String>	
1	Alice
2	Bob
3	Charlie

And add link with object.

```
@startuml
object London

map CapitalCity {
  UK *-> London
  USA => Washington
  Germany => Berlin
}
@enduml
```

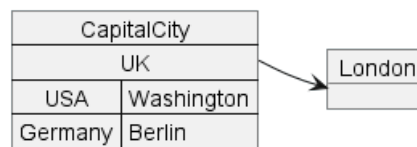

```
@startuml
object London
object Washington
object Berlin
object NewYork

map CapitalCity {
  UK *-> London
  USA *--> Washington
  Germany *---> Berlin
}

NewYork --> CapitalCity::USA
@enduml
```

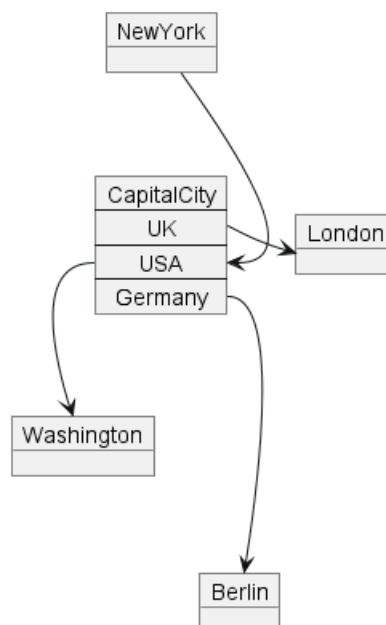

[Ref. #307]



```

@startuml
package foo {
    object baz
}

package bar {
    map A {
        b *-> foo.baz
        c =>
    }
}

A::c --> foo
@enduml

```

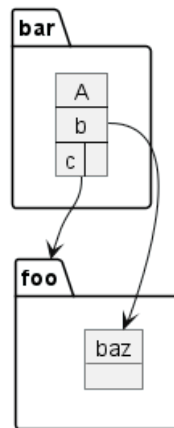

[Ref. QA-12934]

```

@startuml
object Foo
map Bar {
    abc=>
    def=>
}
object Baz

Bar::abc --> Baz : Label one
Foo --> Bar::def : Label two
@enduml

```

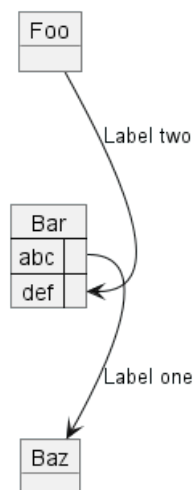

[Ref. #307]

## 4.7 Program (or project) evaluation and review technique (PERT) with map

You can use map table in order to make Program (or project) evaluation and review technique (PERT) diagram.

```

@startuml PERT
left to right direction
' Horizontal lines: -->, <-->, <-->
' Vertical lines: ->, <-, <->
title PERT: Project Name

map Kick.Off {
}
map task.1 {
  Start => End
}
map task.2 {
  Start => End
}
map task.3 {
  Start => End
}
map task.4 {
  Start => End
}
map task.5 {
  Start => End
}
Kick.Off --> task.1 : Label 1
Kick.Off --> task.2 : Label 2
Kick.Off --> task.3 : Label 3
task.1 --> task.4
task.2 --> task.4
task.3 --> task.4
task.4 --> task.5 : Label 4
@enduml

```

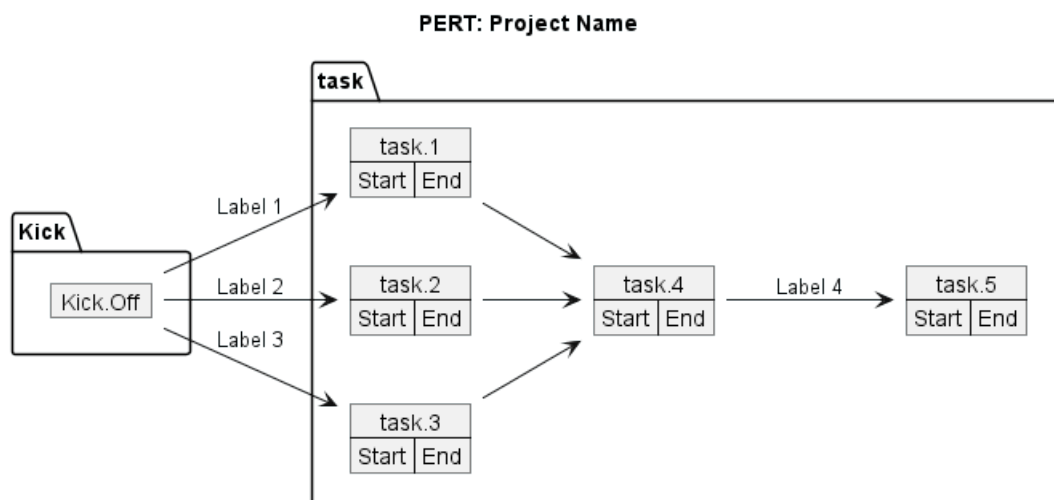

[Ref. QA-12337]



## 4.8 Display JSON Data on Class or Object diagram

### 4.8.1 Simple example

```
@startuml
class Class
object Object
json JSON {
  "fruit": "Apple",
  "size": "Large",
  "color": ["Red", "Green"]
}
@enduml
```

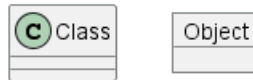

JSON	
fruit	Apple
size	Large
color	Red
	Green

[Ref. QA-15481]

For another example, see on JSON page.



## 5 Activity Diagram (legacy)

This is the old **Activity Diagram (legacy)** syntax, to see the new current version see: **Activity Diagram (new)**.

### 5.1 Simple Action

You can use (\*) for the starting point and ending point of the activity diagram.

In some occasion, you may want to use (\*top) to force the starting point to be at the top of the diagram.

Use --> for arrows.

```
@startuml
(*) --> "First Action"
"First Action" --> (*)
@enduml
```

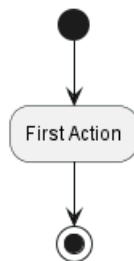

### 5.2 Label on arrows

By default, an arrow starts at the last used activity.

You can put a label on an arrow using brackets [ and ] just after the arrow definition.

```
@startuml
(*) --> "First Action"
-->[You can put also labels] "Second Action"
--> (*)
@enduml
```

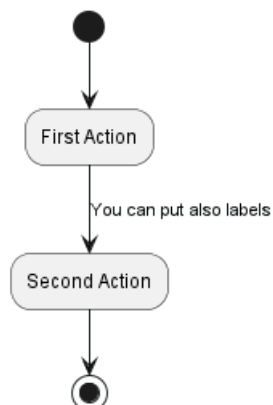

### 5.3 Changing arrow direction

You can use -> for horizontal arrows. It is possible to force arrow's direction using the following syntax:

- -down-> (default arrow)



- -right-> or ->
- -left->
- -up->

```
@startuml
```

```
(*) -up-> "First Action"
-right-> "Second Action"
--> "Third Action"
-left-> (*)
```

```
@enduml
```

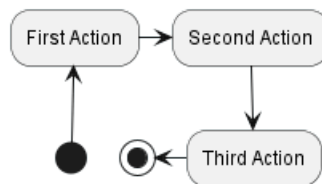

## 5.4 Branches

You can use if/then/else keywords to define branches.

```
@startuml
```

```
(*) --> "Initialization"
```

```
if "Some Test" then
```

```
-->[true] "Some Action"
```

```
--> "Another Action"
```

```
-right-> (*)
```

```
else
```

```
->[false] "Something else"
```

```
-->[Ending process] (*)
```

```
endif
```

```
@enduml
```

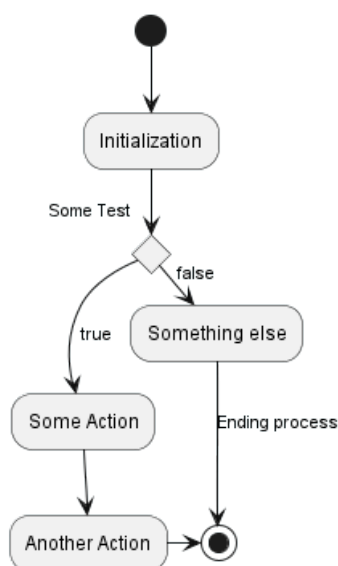

Unfortunately, you will have to sometimes repeat the same activity in the diagram text:

```
@startuml
```



```

(*) --> "check input"
If "input is verbose" then
--> [Yes] "turn on verbosity"
--> "run command"
else
--> "run command"
Endif
-->(*)
@enduml

```

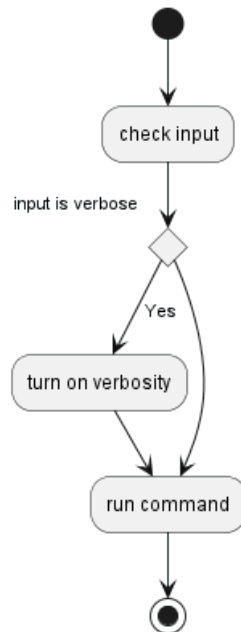

## 5.5 More on Branches

By default, a branch is connected to the last defined activity, but it is possible to override this and to define a link with the `if` keywords.

It is also possible to nest branches.

```

@startuml
(*) --> if "Some Test" then
    -->[true] "action 1"
    if "" then
        -> "action 3" as a3
    else
        if "Other test" then
            -left-> "action 5"
        else
            --> "action 6"
        endif
    endif
else
    ->[false] "action 2"
endif

```



```

a3 --> if "last test" then
  --> "action 7"
else
  -> "action 8"
endif
@enduml

```

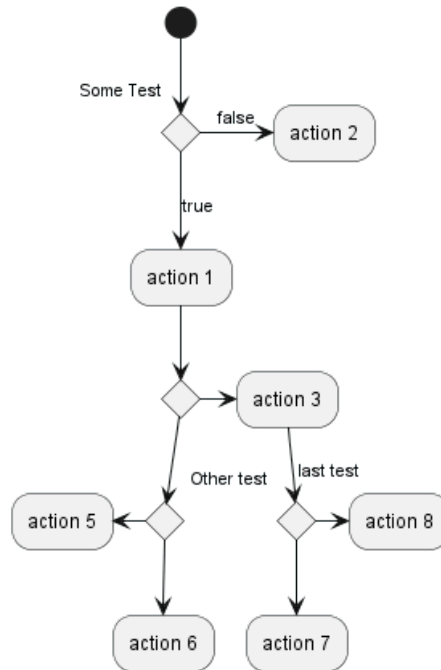

## 5.6 Synchronization

You can use `=== code ===` to display synchronization bars.

```

@startuml

(*) --> ===B1===
--> "Parallel Action 1"
--> ===B2===

===B1=== --> "Parallel Action 2"
--> ===B2===

--> (*)

@enduml

```

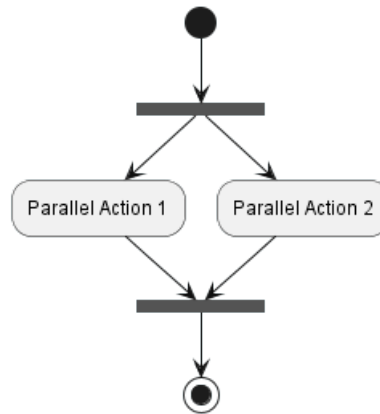

## 5.7 Long action description

When you declare activities, you can span on several lines the description text. You can also add in the description.

You can also give a short code to the activity with the `as` keyword. This code can be used latter in the diagram description.

```

@startuml
(*) -left-> "this <size:20>action</size>
is <b>very</b> <color:red>long2</color>
and defined on several lines
that contains many <i>text</i>" as A1

-up-> "Another action\n on several lines"

A1 --> "Short action <img:sourceforge.jpg>"
@enduml
  
```

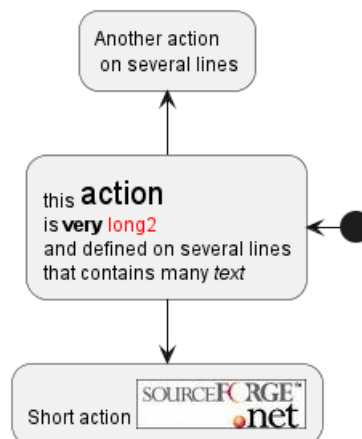

## 5.8 Notes

You can add notes on a activity using the commands `note left`, `note right`, `note top` or `note bottom`, just after the description of the activity you want to note.

If you want to put a note on the starting point, define the note at the very beginning of the diagram description.

You can also have a note on several lines, using the `endnote` keywords.

```

@startuml

(*) --> "Some action"
  
```



```

note right: This action has to be defined
"Some action" --> (*)
note left
  This note is on
  several lines
end note

@enduml

```

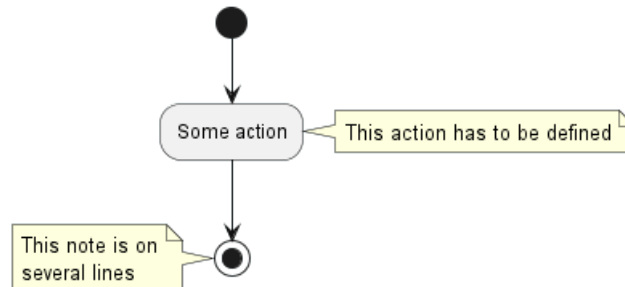

## 5.9 Partition

You can define a partition using the `partition` keyword, and optionally declare a background color for your partition (Using a html color code or name)

When you declare activities, they are automatically put in the last used partition.

You can close the partition definition using a closing bracket `}`.

```

@startuml

partition Conductor {
  (*) --> "Climbs on Platform"
  --> === S1 ===
  --> Bows
}

partition Audience #LightSkyBlue {
  === S1 === --> Applauds
}

partition Conductor {
  Bows --> === S2 ===
  --> WavesArmes
  Applauds --> === S2 ===
}

partition Orchestra #CCCCEE {
  WavesArmes --> Introduction
  --> "Play music"
}

@enduml

```

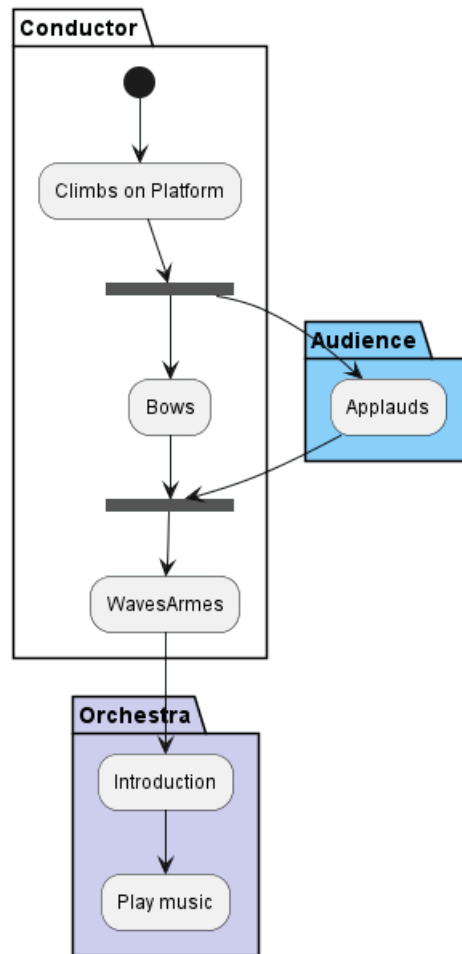

## 5.10 Skinparam

You can use the skinparam command to change colors and fonts for the drawing.

You can use this command :

- In the diagram definition, like any other commands,
- In an included file,
- In a configuration file, provided in the command line or the ANT task.

You can define specific color and fonts for stereotyped activities.

```
@startuml
```

```
skinparam backgroundColor #AFFFFFFF
skinparam activity {
  StartColor red
  BarColor SaddleBrown
  EndColor Silver
  BackgroundColor Peru
  BackgroundColor<< Begin >> Olive
  BorderColor Peru
  FontName Impact
}
```

```
(* ) --> "Climbs on Platform" << Begin >>
--> === S1 ===
--> Bows
```



```

--> === S2 ===
--> WavesArmes
--> (*)

@enduml

```

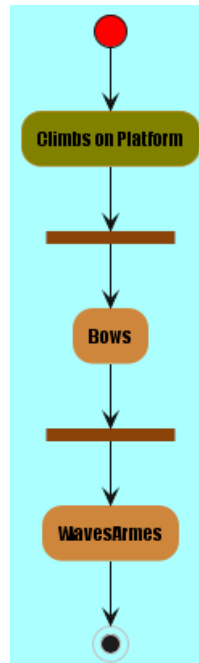

## 5.11 Octagon

You can change the shape of activities to octagon using the `skinparam activityShape octagon` command.

```

@startuml
'Default is skinparam activityShape roundBox
skinparam activityShape octagon

(*) --> "First Action"
"First Action" --> (*)

@enduml

```

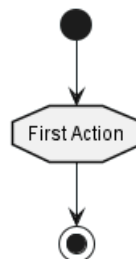

## 5.12 Complete example

```

@startuml
title Servlet Container

(*) --> "ClickServlet.handleRequest()"
--> "new Page"

if "Page.onSecurityCheck" then

```





```
->[true] "Page.onInit()"

if "isForward?" then
  ->[no] "Process controls"

  if "continue processing?" then
    -->[yes] ===RENDERING===
  else
    -->[no] ===REDIRECT_CHECK===
  endif

else
  -->[yes] ===RENDERING===
endif

if "is Post?" then
  -->[yes] "Page.onPost()"
  --> "Page.onRender()" as render
  --> ===REDIRECT_CHECK===
else
  -->[no] "Page.onGet()"
  --> render
endif

else
  -->[false] ===REDIRECT_CHECK===
endif

if "Do redirect?" then
  ->[yes] "redirect request"
  --> ===BEFORE_DESTROY===
else
  if "Do Forward?" then
    -left->[yes] "Forward request"
    --> ===BEFORE_DESTROY===
  else
    -right->[no] "Render page template"
    --> ===BEFORE_DESTROY===
  endif
endif

--> "Page.onDestroy()"
-->(*)

@enduml
```

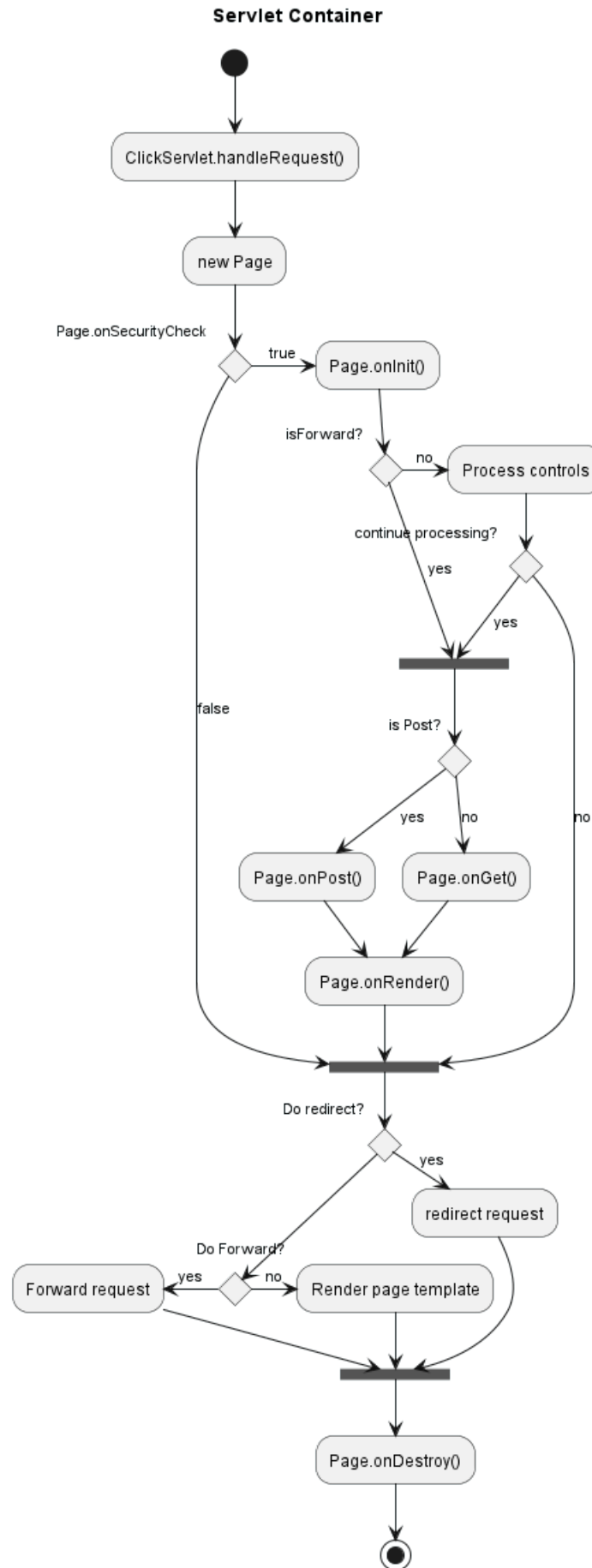

## 6 Activity Diagram (New Syntax)

The previous syntax used for activity diagrams encountered several limitations and maintainability issues. Recognizing these drawbacks, we have introduced a wholly revamped syntax and implementation that is not only user-friendly but also more stable.

### 6.0.1 Benefits of the New Syntax

- No Dependency on Graphviz: Just like with sequence diagrams, the new syntax eliminates the necessity for Graphviz installation, thereby simplifying the setup process.
- Ease of Maintenance: The intuitive nature of the new syntax means it is easier to manage and maintain your diagrams.

### 6.0.2 Transition to the New Syntax

While we will continue to support the old syntax to maintain compatibility, we highly encourage users to migrate to the new syntax to leverage the enhanced features and benefits it offers.

Make the shift today and experience a more streamlined and efficient diagramming process with the new activity diagram syntax.

## 6.1 Simple action

Activities label starts with `:` and ends with `;`.

Text formatting can be done using creole wiki syntax.

They are implicitly linked in their definition order.

```
@startuml
:Hello world;
:This is defined on
several lines;
@enduml
```

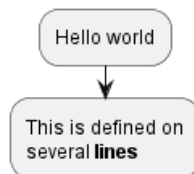

## 6.2 Start/Stop/End

You can use `start` and `stop` keywords to denote the beginning and the end of a diagram.

```
@startuml
start
:Hello world;
:This is defined on
several lines;
stop
@enduml
```

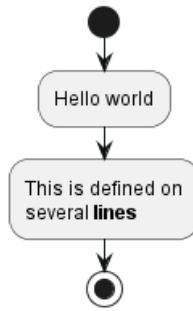

You can also use the `end` keyword.

```

@startuml
start
:Hello world;
:This is defined on
several lines;
end
@enduml
  
```

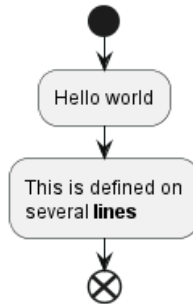

### 6.3 Conditional

You can use `if`, `then` and `else` keywords to put tests in your diagram. Labels can be provided using parentheses.

The 3 syntaxes are possible:

- `if (...) then (...)`

```

@startuml
start

if (Graphviz installed?) then (yes)
  :process all\ndiagrams;
else (no)
  :process only
  __sequence__ and __activity__ diagrams;
endif

stop
@enduml
  
```

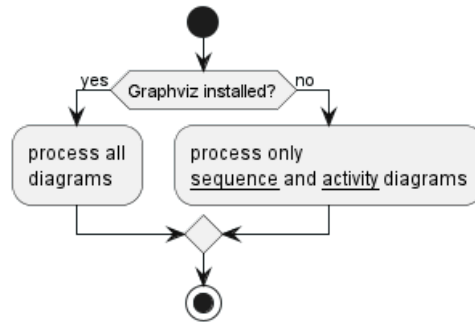

- if (...) is (...) then

```

@startuml
if (color?) is (<color:red>red) then
:print red;
else
:print not red;
@enduml
  
```

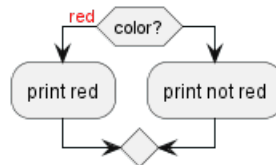

- if (...) equals (...) then

```

@startuml
if (counter?) equals (5) then
:print 5;
else
:print not 5;
@enduml
  
```

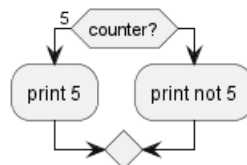

[Ref. QA-301]

### 6.3.1 Several tests (horizontal mode)

You can use the `elseif` keyword to have several tests (*by default, it is the horizontal mode*):

```

@startuml
start
if (condition A) then (yes)
:Text 1;
elseif (condition B) then (yes)
:Text 2;
stop
(no) elseif (condition C) then (yes)
:Text 3;
(no) elseif (condition D) then (yes)
:Text 4;
else (nothing)
  
```



```

:Text else;
endif
stop
@enduml

```

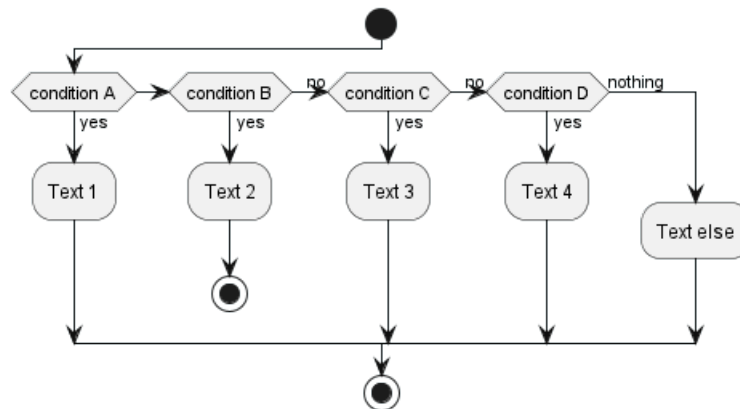

### 6.3.2 Several tests (vertical mode)

You can use the command `!pragma useVerticalIf on` to have the tests in vertical mode:

```

@startuml
!pragma useVerticalIf on
start
if (condition A) then (yes)
:Text 1;
elseif (condition B) then (yes)
:Text 2;
stop
elseif (condition C) then (yes)
:Text 3;
elseif (condition D) then (yes)
:Text 4;
else (nothing)
:Text else;
endif
stop
@enduml

```

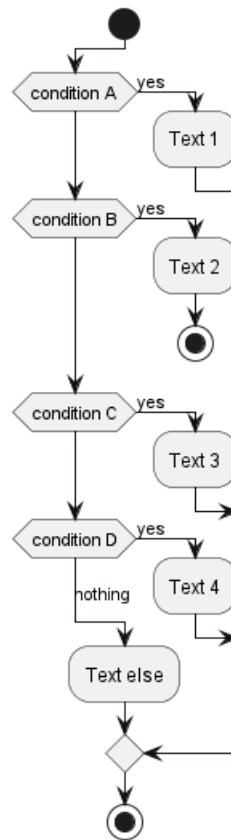

You can use the `-P` command-line option to specify the pragma:

```
java -jar plantuml.jar -PuseVerticalIf=on
```

[Refs. QA-3931, issue-582]

## 6.4 Switch and case [switch, case, endswitch]

You can use `switch`, `case` and `endswitch` keywords to put switch in your diagram.

Labels can be provided using parentheses.

```

@startuml
start
switch (test?)
case ( condition A )
:Text 1;
case ( condition B )
:Text 2;
case ( condition C )
:Text 3;
case ( condition D )
:Text 4;
case ( condition E )
:Text 5;
endswitch
stop
@enduml
  
```



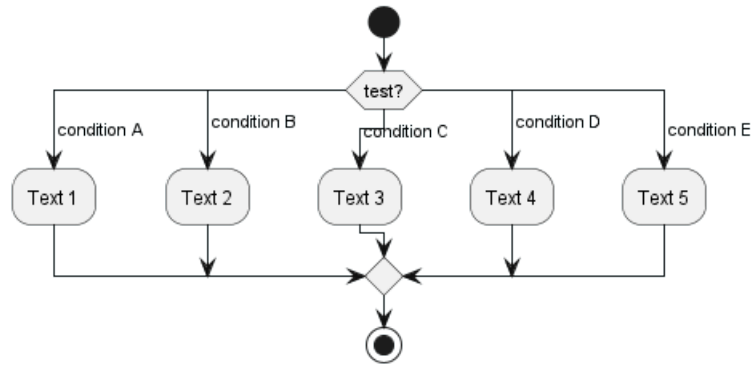

### 6.5 Conditional with stop on an action [kill, detach]

You can stop action on a if loop.

```

@startuml
if (condition?) then
    :error;
    stop
endif
#palegreen:action;
@enduml
    
```

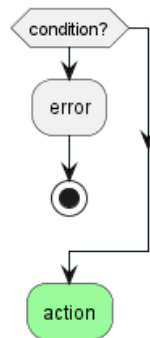

But if you want to stop at the precise action, you can use the `kill` or `detach` keyword:

- `kill`

```

@startuml
if (condition?) then
    #pink:error;
    kill
endif
#palegreen:action;
@enduml
    
```

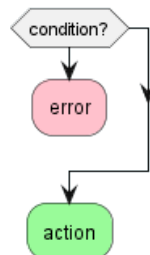

[Ref. QA-265]

- `detach`



```

@startuml
if (condition?) then
  #pink:error;
  detach
endif
#palegreen:action;
@enduml

```

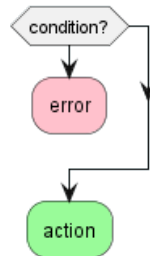

## 6.6 Repeat loop

### 6.6.1 Simple repeat loop

You can use `repeat` and `repeat while` keywords to have repeat loops.

```

@startuml
start
repeat
  :read data;
  :generate diagrams;
repeat while (more data?) is (yes)
->no;
stop
@enduml

```

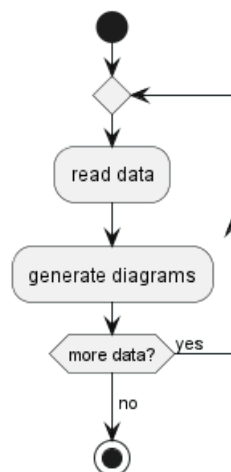

### 6.6.2 Repeat loop with repeat action and backward action

It is also possible to use a full action as `repeat` target and insert an action in the return path using the `backward` keyword.

```

@startuml
start

```



```

repeat :foo as starting label;
  :read data;
  :generate diagrams;
backward:This is backward;
repeat while (more data?)

stop

@enduml

```

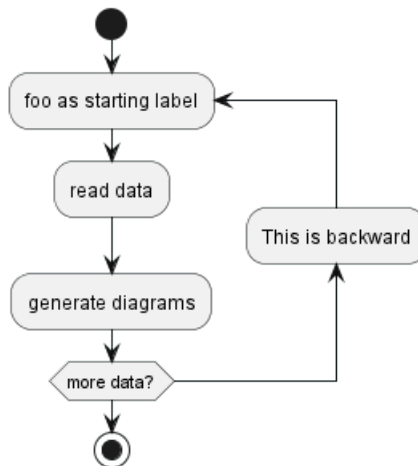

[Ref. QA-5826]

## 6.7 Break on a repeat loop [break]

You can use the `break` keyword after an action on a loop.

```

@startuml
start
repeat
  :Test something;
  if (Something went wrong?) then (no)
    #palegreen:OK;
    break
  endif
  ->NOK;
  :Alert "Error with long text";
repeat while (Something went wrong with long text?) is (yes) not (no)
->//merged step//;
:Alert "Success";
stop
@enduml

```

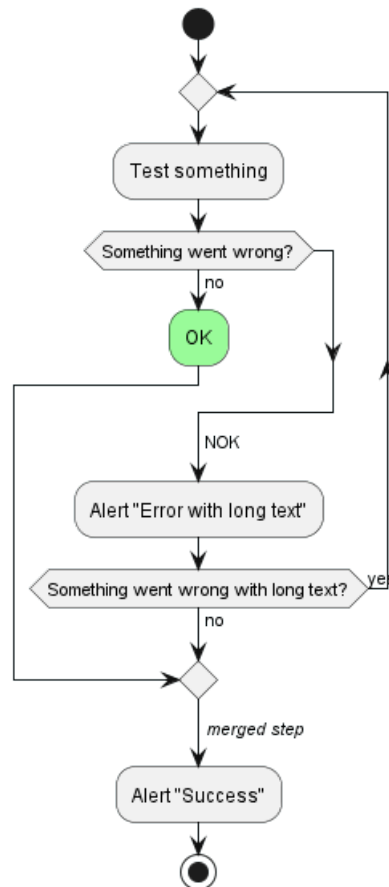

[Ref. QA-6105]

## 6.8 Goto and Label Processing [label, goto]

It is currently only experimental

You can use `label` and `goto` keywords to denote goto processing, with:

- `label <label_name>`
- `goto <label_name>`

```

@startuml
title Point two queries to same activity\nwith `goto`
start
if (Test Question?) then (yes)
'space label only for alignment
label sp_lab0
label sp_lab1
'real label
label lab
:shared;
else (no)
if (Second Test Question?) then (yes)
label sp_lab2
goto sp_lab1
else
:nonShared;
endif
endif
:merge;
  
```



```
@enduml
```

Point two queries to same activity  
with `goto`

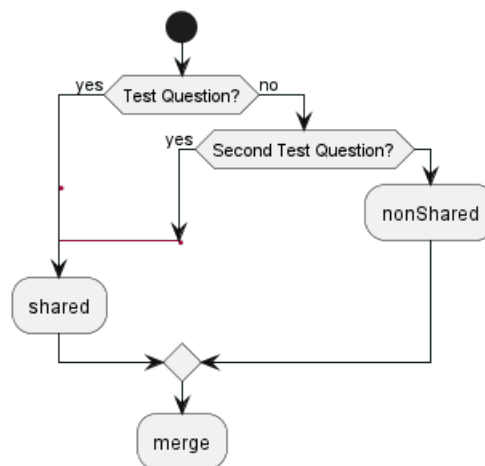

[Ref. QA-15026, QA-12526 and initially QA-1626]

## 6.9 While loop

### 6.9.1 Simple while loop

You can use `while` and `endwhile` keywords to have while loop.

```
@startuml
start

while (data available?)
  :read data;
  :generate diagrams;
endwhile

stop

@enduml
```

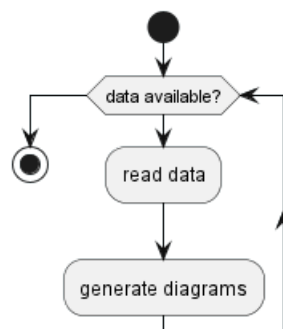

It is possible to provide a label after the `endwhile` keyword, or using the `is` keyword.

```
@startuml
while (check filesize ?) is (not empty)
  :read file;
endwhile (empty)
:close file;
```



```
@enduml
```

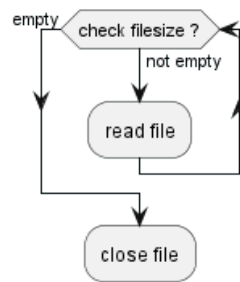

### 6.9.2 While loop with backward action

It is also possible to insert an action in the return path using the **backward** keyword.

```
@startuml
while (check filesize ?) is (not empty)
  :read file;
  backward:log;
endwhile (empty)
:close file;
@enduml
```

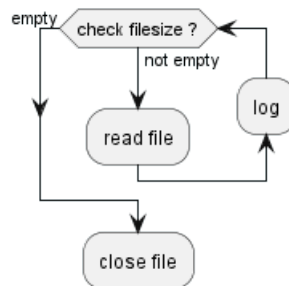

[Ref. QA-11144]

### 6.9.3 Infinite while loop

If you are using **detach** to form an infinite while loop, then you will want to also hide the partial arrow that results using **-[hidden]->**

```
@startuml
:Step 1;
if (condition1) then
  while (loop forever)
    :Step 2;
  endwhile
  -[hidden]->
  detach
else
  :end normally;
  stop
endif
@enduml
```



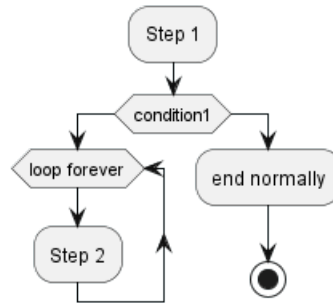

## 6.10 Parallel processing [fork, fork again, end fork, end merge]

You can use fork, fork again and end fork or end merge keywords to denote parallel processing.

### 6.10.1 Simple fork

```

@startuml
start
fork
  :action 1;
fork again
  :action 2;
end fork
stop
@enduml
  
```

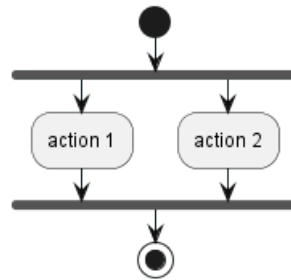

### 6.10.2 fork with end merge

```

@startuml
start
fork
  :action 1;
fork again
  :action 2;
end merge
stop
@enduml
  
```

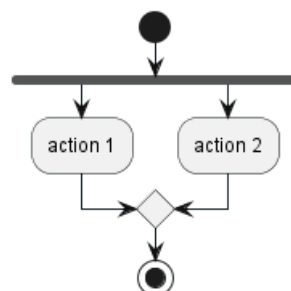

[Ref. QA-5320]

```

@startuml
start
fork
    :action 1;
fork again
    :action 2;
fork again
    :action 3;
fork again
    :action 4;
end merge
stop
@enduml
    
```

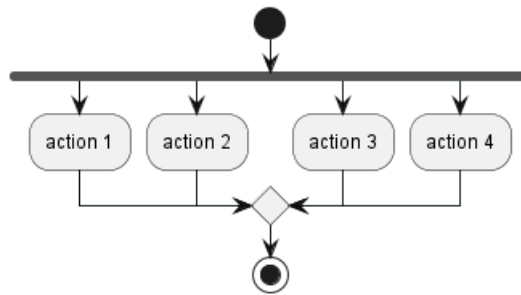

```

@startuml
start
fork
    :action 1;
fork again
    :action 2;
end
end merge
stop
@enduml
    
```

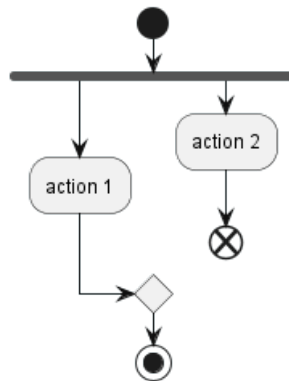

[Ref. QA-13731]

**6.10.3 Label on end fork (or UML joinspec):**

```

@startuml
start
fork
    :action A;
fork again
    
```

```

    :action B;
end fork {or}
stop
@enduml

```

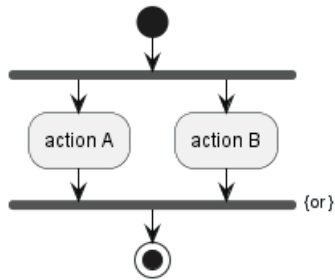

```

@startuml
start
fork
    :action A;
fork again
    :action B;
end fork {and}
stop
@enduml

```

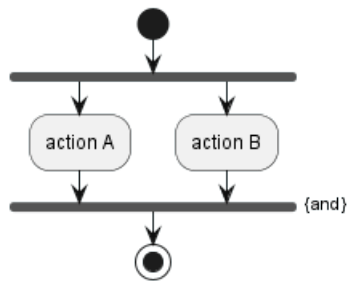

[Ref. QA-5346]

#### 6.10.4 Other example

```

@startuml
start
if (multiprocessor?) then (yes)
    fork
        :Treatment 1;
    fork again
        :Treatment 2;
    end fork
else (monoproc)
    :Treatment 1;
    :Treatment 2;
endif
@enduml

```



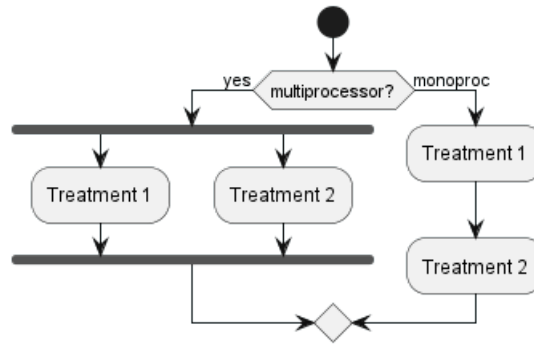

## 6.11 Split processing

### 6.11.1 Split

You can use `split`, `split again` and `end split` keywords to denote split processing.

```

@startuml
start
split
  :A;
split again
  :B;
split again
  :C;
split again
  :a;
  :b;
end split
:D;
end
@enduml
  
```

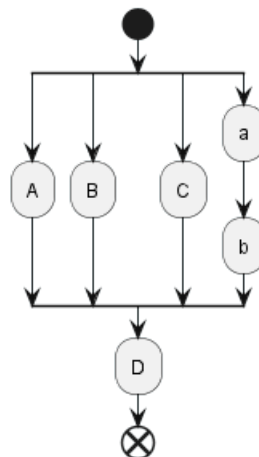

### 6.11.2 Input split (multi-start)

You can use `hidden` arrows to make an input split (multi-start):

```

@startuml
split
  -[hidden]->
  :A;
split again
  -[hidden]->
  
```



```

    :B;
split again
  -[hidden]->
    :C;
end split
:D;
@enduml

```

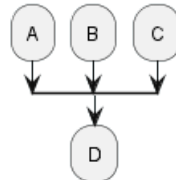

```

@startuml
split
  -[hidden]->
    :A;
split again
  -[hidden]->
    :a;
    :b;
split again
  -[hidden]->
    (Z)
end split
:D;
@enduml

```

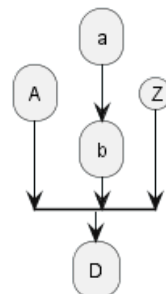

[Ref. QA-8662]

### 6.11.3 Output split (multi-end)

You can use `kill` or `detach` to make an output split (multi-end):

```

@startuml
start
split
  :A;
  kill
split again
  :B;
  detach
split again
  :C;
  kill

```



```
end split
@enduml
```

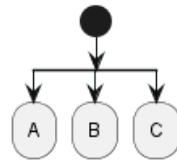

```
@startuml
start
split
  :A;
  kill
split again
  :b;
  :c;
  detach
split again
  (Z)
  detach
split again
  end
split again
  stop
end split
@enduml
```

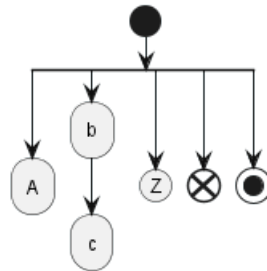

## 6.12 Notes

Text formatting can be done using creole wiki syntax.

A note can be floating, using `floating` keyword.

```
@startuml
start
:foo1;
floating note left: This is a note
:foo2;
note right
  This note is on several
  //lines// and can
  contain <b>HTML</b>
  ====
  * Calling the method ""foo()"" is prohibited
end note
stop
@enduml
```



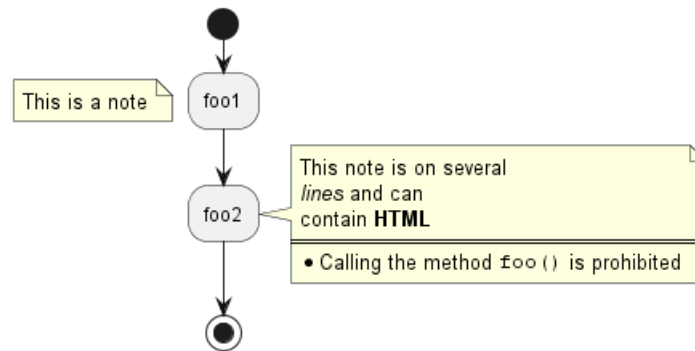

You can add note on backward activity:

```

@startuml
start
repeat :Enter data;
:Submit;
backward :Warning;
note right: Note
repeat while (Valid?) is (No) not (Yes)
stop
@enduml
  
```

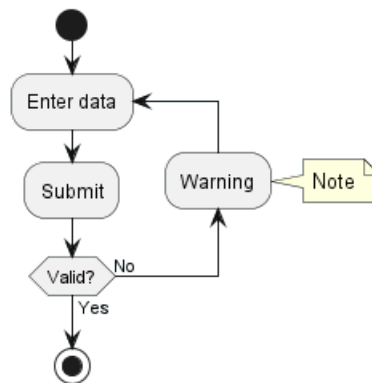

[Ref. QA-11788]

You can add note on partition activity:

```

@startuml
start
partition "**process** HelloWorld" {
  note
    This is my note
    ----
    //Creole test//
  end note
  :Ready;
  :HelloWorld(i)>
  :Hello-Sent;
}
@enduml
  
```

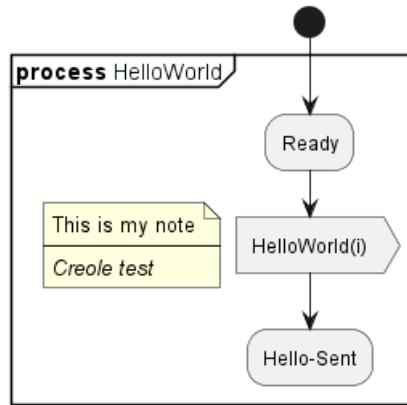

[Ref. QA-2398]

## 6.13 Colors

You can specify a color for some activities.

```
@startuml
```

```
start
```

```
:starting progress;
```

```
#HotPink:reading configuration files
```

```
These files should be edited at this point!;
```

```
#AAAAAA:ending of the process;
```

```
@enduml
```

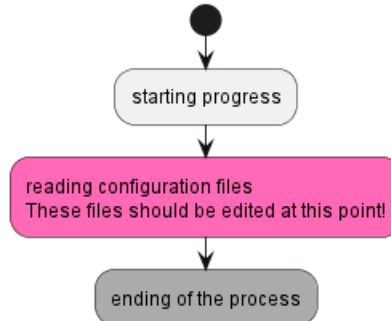

You can also use gradient color.

```
@startuml
```

```
start
```

```
partition #red/white testPartition {
    #blue\green:testActivity;
}
```

```
}
```

```
@enduml
```

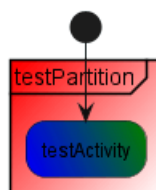

[Ref. QA-4906]

## 6.14 Lines without arrows

You can use skinparam ArrowHeadColor none in order to connect activities using lines only, without arrows.

```
@startuml
skinparam ArrowHeadColor none
start
:Hello world;
:This is on defined on
several **lines**;
stop
@enduml
```

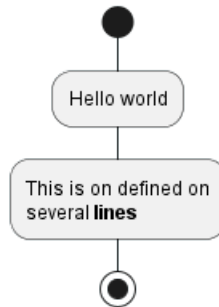

```
@startuml
skinparam ArrowHeadColor none
start
repeat :Enter data;
:Submit;
backward :Warning;
repeat while (Valid?) is (No) not (Yes)
stop
@enduml
```

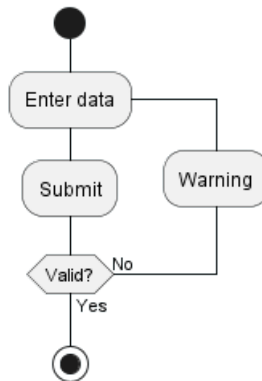

## 6.15 Arrows

Using the -> notation, you can add texts to arrow, and change their color.

It's also possible to have dotted, dashed, bold or hidden arrows.

```
@startuml
:foo1;
-> You can put text on arrows;
if (test) then
-[#blue]->
:foo2;
-[#green,dashed]-> The text can
```



```

also be on several lines
and very long...;
:foo3;
else
-[#black,dotted]->
:foo4;
endif
-[#gray,bold]->
:foo5;
@enduml

```

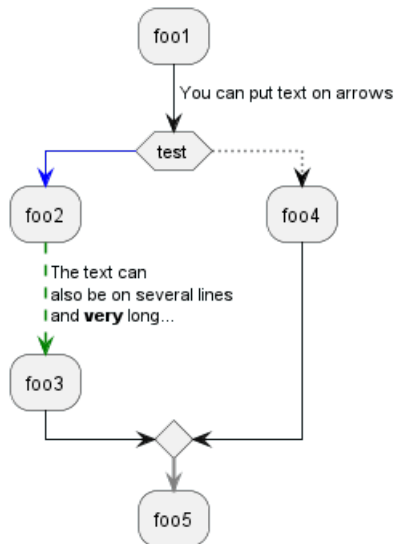

## 6.16 Connector

You can use parentheses to denote connector.

```

@startuml
start
:Some activity;
(A)
detach
(A)
:Other activity;
@enduml

```

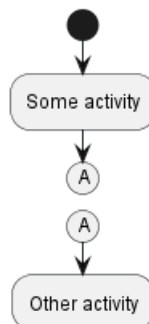

## 6.17 Color on connector

You can add color on connector.

```

@startuml

```



```

start
:The connector below
wishes he was blue;
#blue:(B)
:This next connector
feels that she would
be better off green;
#green:(G)
stop
@enduml

```

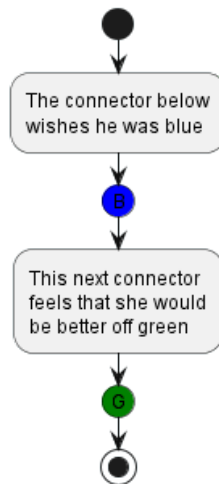

[Ref. QA-10077]

## 6.18 Grouping or partition

### 6.18.1 Group

You can group activity together by defining group:

```

@startuml
start
group Initialization
:read config file;
:init internal variable;
end group
group Running group
:wait for user interaction;
:print information;
end group

stop
@enduml

```



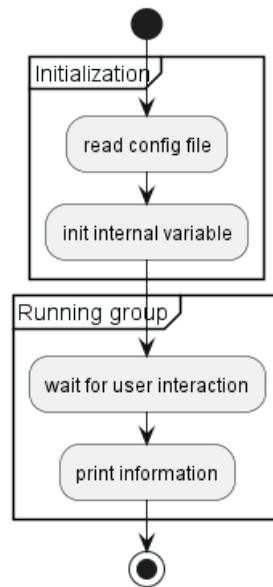

### 6.18.2 Partition

You can group activity together by defining partition:

```

@startuml
start
partition Initialization {
    :read config file;
    :init internal variable;
}
partition Running {
    :wait for user interaction;
    :print information;
}
stop
@enduml
  
```

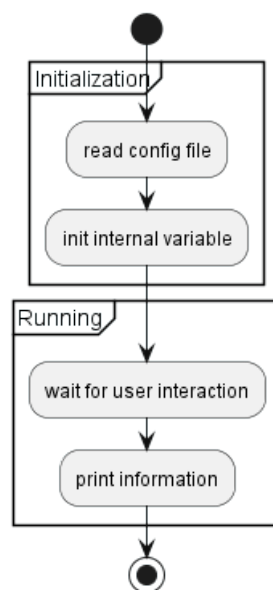

It's also possible to change partition color:



```

@startuml
start
partition #lightGreen "Input Interface" {
    :read config file;
    :init internal variable;
}
partition Running {
    :wait for user interaction;
    :print information;
}
stop
@enduml

```

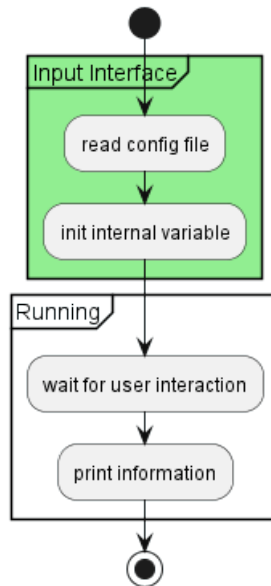

[Ref. QA-2793]

It's also possible to add link to partition:

```

@startuml
start
partition "[[http://plantuml.com partition_name]]" {
    :read doc. on [[http://plantuml.com plantuml_website]];
    :test diagram;
}
end
@enduml

```

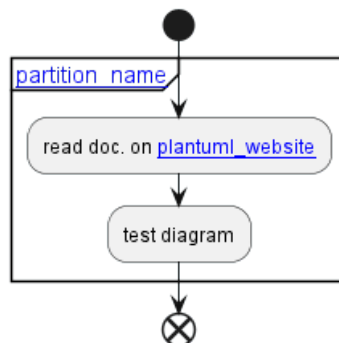

[Ref. QA-542]

### 6.18.3 Group, Partition, Package, Rectangle or Card

You can group activity together by defining:

- group;
- partition;
- package;
- rectangle;
- card.

```
@startuml
start
group Group
  :Activity;
end group
floating note: Note on Group

partition Partition {
  :Activity;
}
floating note: Note on Partition

package Package {
  :Activity;
}
floating note: Note on Package

rectangle Rectangle {
  :Activity;
}
floating note: Note on Rectangle

card Card {
  :Activity;
}
floating note: Note on Card
end
@enduml
```

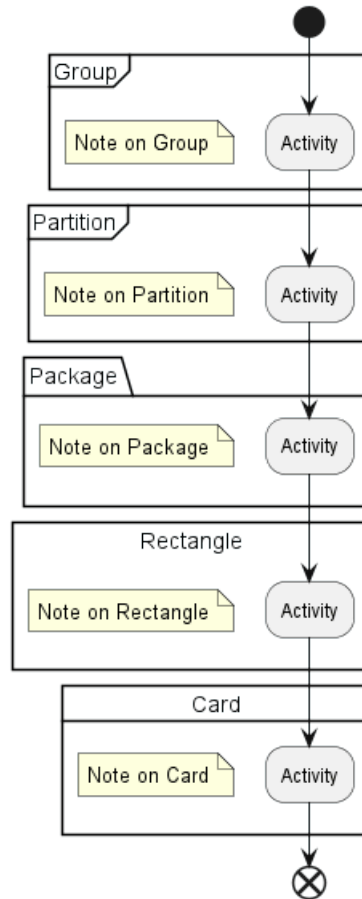

## 6.19 Swimlanes

Using pipe |, you can define swimlanes.

It's also possible to change swimlanes color.

```

@startuml
|Swimlane1|
start
:foo1;
|#AntiqueWhite|Swimlane2|
:foo2;
:foo3;
|Swimlane1|
:foo4;
|Swimlane2|
:foo5;
stop
@enduml
  
```

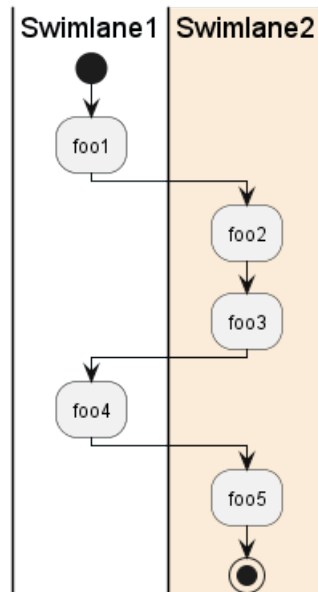

You can add `if` conditional or `repeat` or `while` loop within swimlanes.

```

@startuml
|#pink|Actor_For_red|
start
if (color?) is (red) then
#pink:**action red**;
:foo1;
else (not red)
|#lightgray|Actor_For_no_red|
#lightgray:**action not red**;
:foo2;
endif
|Next_Actor|
#lightblue:foo3;
:foo4;
|Final_Actor|
#palegreen:foo5;
stop
@enduml
  
```

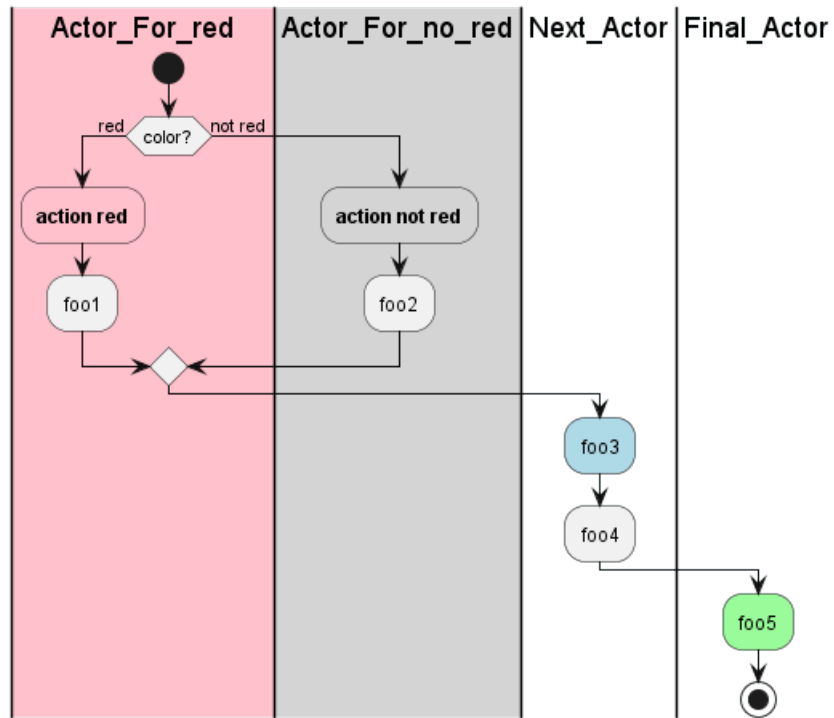

You can also use `alias` with swimlanes, with this syntax:

- |[#<color>|]<swimlane\_alias>| <swimlane\_title>

```
@startuml
|#palegreen|f| fisherman
|c| cook
|#gold|e| eater
|f|
start
:go fish;
|c|
:fry fish;
|e|
:eat fish;
stop
@enduml
```

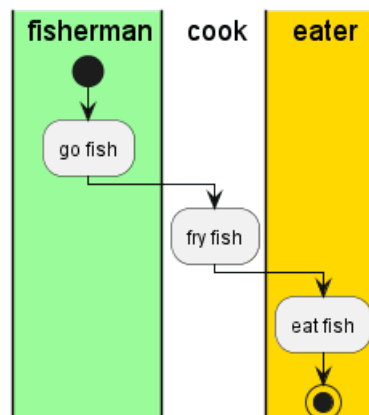

[Ref. QA-2681]

## 6.20 Detach or kill [detach, kill]

It's possible to remove an arrow using the `detach` or `kill` keyword:

- `detach`

```
@startuml
: start;
fork
: foo1;
: foo2;
fork again
: foo3;
detach
endifork
endif
if (foo4) then
: foo5;
detach
endif
: foo6;
detach
: foo7;
stop
@enduml
```

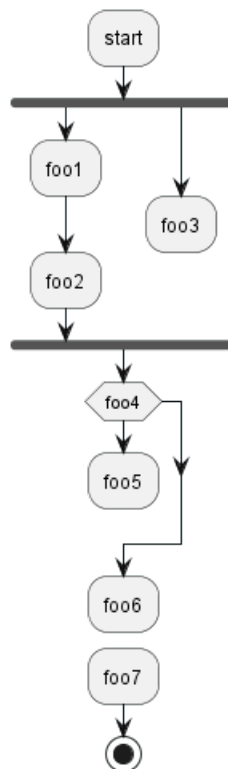

- `kill`

```
@startuml
: start;
fork
: foo1;
: foo2;
fork again
: foo3;
kill
endifork
endif
: foo6;
stop
@enduml
```

```

endfork
if (foo4) then
  :foo5;
  kill
endif
:foo6;
kill
:foo7;
stop
@enduml

```

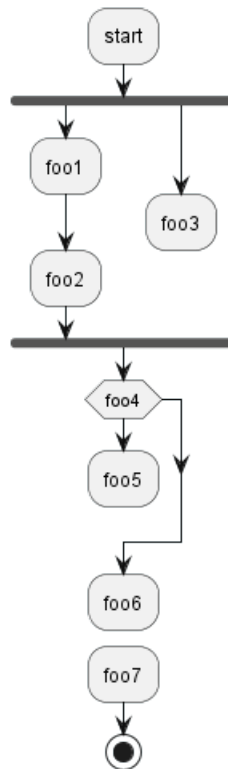

## 6.21 SDL (Specification and Description Language)

### 6.21.1 Table of SDL Shape Name

Name	Old syntax	Stereotype syntax
Input	<	<<input>>
Output	>	<<output>>
Procedure		<<procedure>>
Load	\	<<load>>
Save	/	<<save>>
Continuous	}	<<continuous>>
Task	]	<<task>>

[Ref. QA-11518, GH-1270]

### 6.21.2 SDL using final separator (Deprecated form)

By changing the final ; separator, you can set different rendering for the activity:

- |
- <
- >





```

• /
• \\
• ]
• }

@startuml
:Ready;
:next(o)|
:Receiving;
split
:nak(i)<
:ack(o)>
split again
:ack(i)<
:next(o)
on several lines|
:i := i + 1]
:ack(o)>
split again
:err(i)<
:nak(o)>
split again
:foo/
split again
:bar\\
split again
:i > 5}
stop
end split
:finish;
@enduml

```

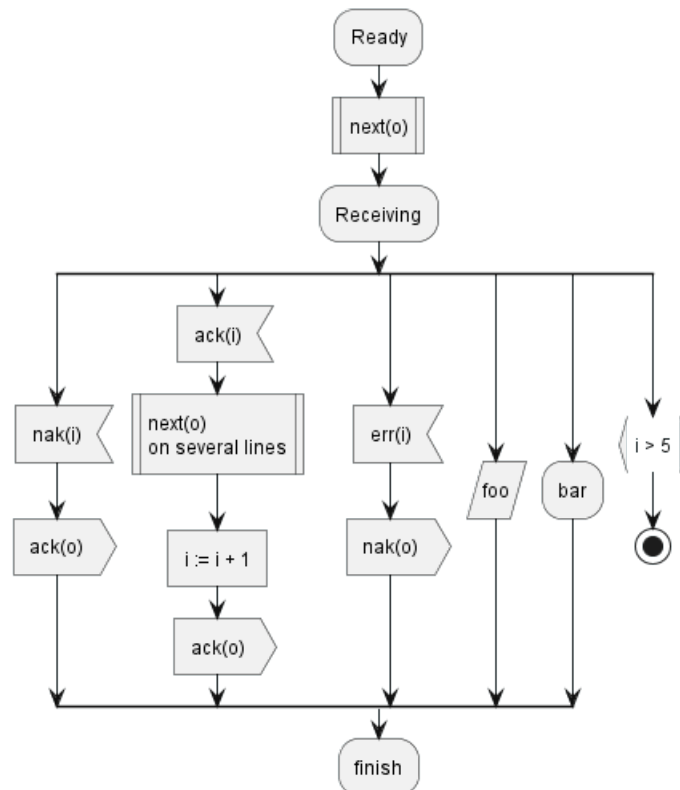

## 6.21.3 SDL using Normal separator and Stereotype (Current official form)

```

@startuml
start
:SDL Shape;
:input; <<input>>
:output; <<output>>
:procedure; <<procedure>>
:load; <<load>>
:save; <<save>>
:continuous; <<continuous>>
:task; <<task>>
end
@enduml

```

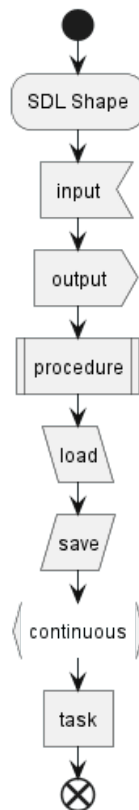

```

@startuml
:Ready;
:next(o); <<procedure>>
:Receiving;
split
  :nak(i); <<input>>
  :ack(o); <<output>>
split again
  :ack(i); <<input>>
  :next(o)
  on several lines; <<procedure>>
  :i := i + 1; <<task>>
  :ack(o); <<output>>
split again
  :err(i); <<input>>
  :nak(o); <<output>>
split again
  :foo; <<save>>

```



```

split again
:bar; <<load>>
split again
:i > 5; <<continuous>>
stop
end split
:finish;
@enduml

```

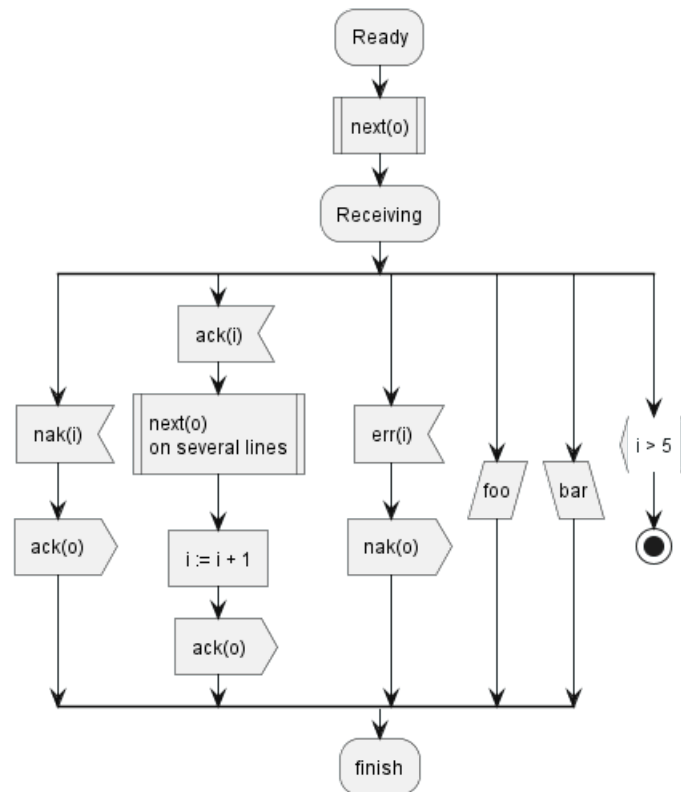

## 6.22 Complete example

```

@startuml

start
:ClickServlet.handleRequest();
:new page;
if (Page.onSecurityCheck) then (true)
:Page.onInit();
if (isForward?) then (no)
:Process controls;
if (continue processing?) then (no)
stop
endif
endif

if (isPost?) then (yes)
:Page.onPost();
else (no)
:Page.onGet();
endif
:Page.onRender();
endif
else (false)

```



```
endif

if (do redirect?) then (yes)
  :redirect process;
else
  if (do forward?) then (yes)
    :Forward request;
  else (no)
    :Render page template;
  endif
endif

stop

@enduml
```

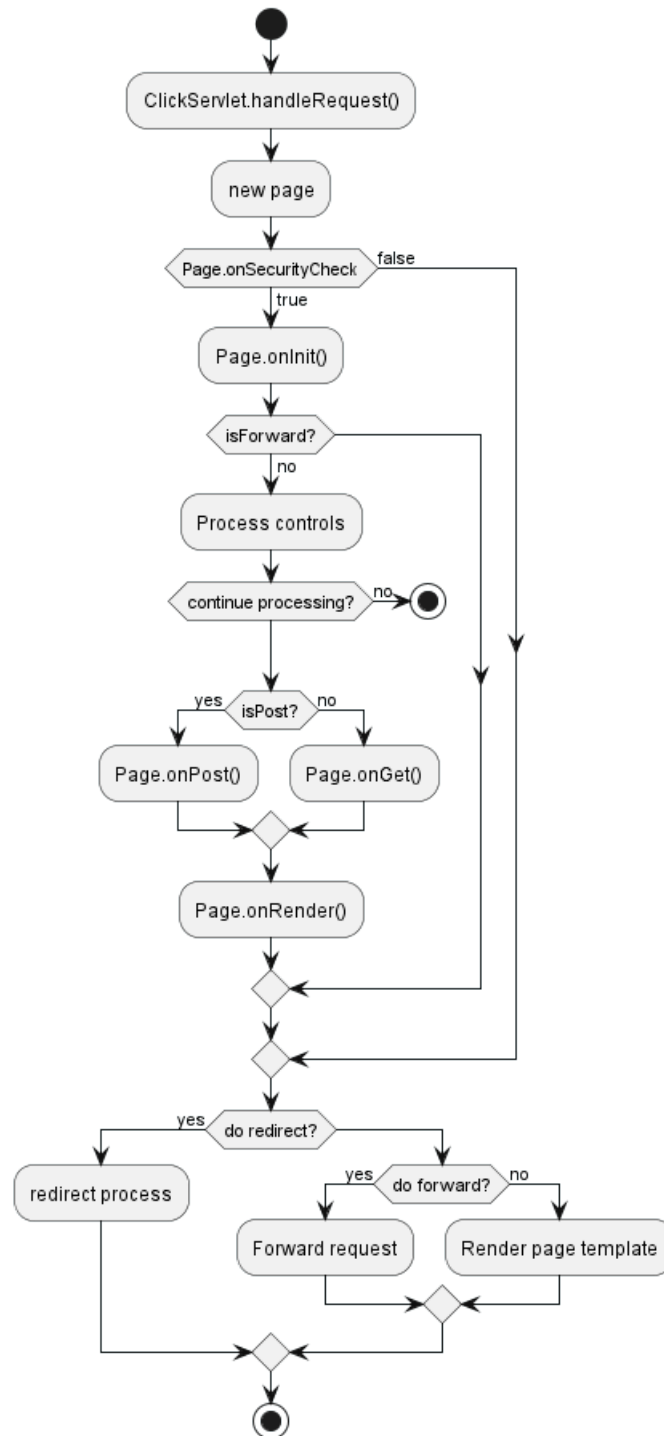

## 6.23 Condition Style

### 6.23.1 Inside style (by default)

```

@startuml
skinparam conditionStyle inside
start
repeat
  :act1;
  :act2;
repeatwhile (<b>end)
:act3;
  
```



```
@enduml
```

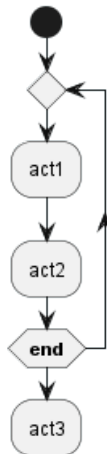

```
@startuml
start
repeat
  :act1;
  :act2;
repeatwhile (<b>end)
:act3;
@enduml
```

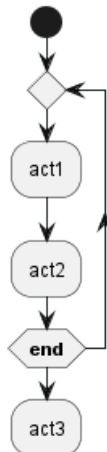

### 6.23.2 Diamond style

```
@startuml
skinparam conditionStyle diamond
start
repeat
  :act1;
  :act2;
repeatwhile (<b>end)
:act3;
@enduml
```

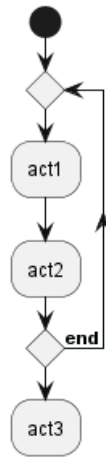

### 6.23.3 InsideDiamond (or *Foo1*) style

```

@startuml
skinparam conditionStyle InsideDiamond
start
repeat
  :act1;
  :act2;
repeatwhile (<b>end)
:act3;
@enduml
  
```

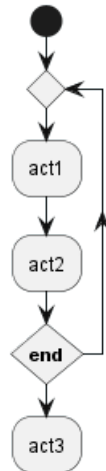

```

@startuml
skinparam conditionStyle fool
start
repeat
  :act1;
  :act2;
repeatwhile (<b>end)
:act3;
@enduml
  
```

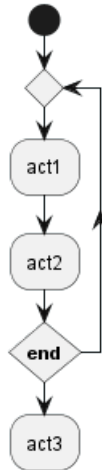

[Ref. QA-1290 and #400]

## 6.24 Condition End Style

### 6.24.1 Diamond style (by default)

- With one branch

```

@startuml
skinparam ConditionEndStyle diamond
:A;
if (decision) then (yes)
  :B1;
else (no)
endif
:C;
@enduml
  
```

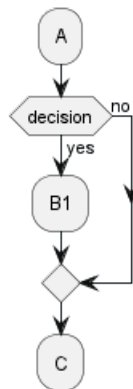

- With two branches (B1, B2)

```

@startuml
skinparam ConditionEndStyle diamond
:A;
if (decision) then (yes)
  :B1;
else (no)
  :B2;
endif
:C;
@enduml
  
```





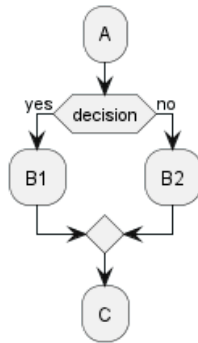

### 6.24.2 Horizontal line (hline) style

- With one branch

```

@startuml
skinparam ConditionEndStyle hline
:A;
if (decision) then (yes)
  :B1;
else (no)
endif
:C;
@enduml
  
```

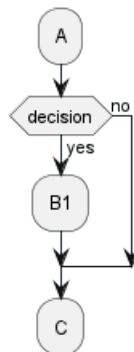

- With two branches (B1, B2)

```

@startuml
skinparam ConditionEndStyle hline
:A;
if (decision) then (yes)
  :B1;
else (no)
  :B2;
endif
:C;
@enduml
@enduml
  
```

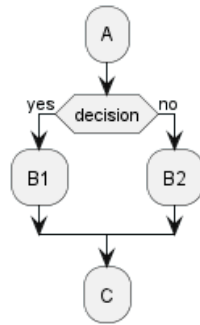

[Ref. QA-4015]

## 6.25 Using (global) style

### 6.25.1 Without style (by default)

```

@startuml
start
:init;
-> test of color;
if (color?) is (<color:red>red) then
:print red;
else
:print not red;
note right: no color
endif
partition End {
:end;
}
-> this is the end;
end
@enduml
  
```

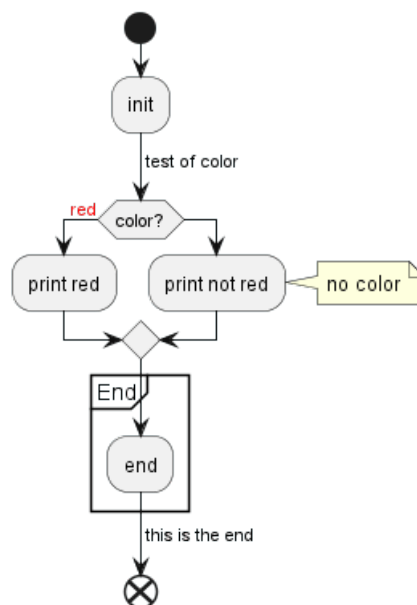

### 6.25.2 With style

You can use style to change rendering of elements.

```

@startuml
  
```



```
<style>
activityDiagram {
  BackgroundColor #33668E
  BorderColor #33668E
  FontColor #888
  FontName arial

  diamond {
    BackgroundColor #ccf
    LineColor #00FF00
    FontColor green
    FontName arial
    FontSize 15
  }
  arrow {
    FontColor gold
    FontName arial
    FontSize 15
  }
  partition {
    LineColor red
    FontColor green
    RoundCorner 10
    BackgroundColor PeachPuff
  }
  note {
    FontColor Blue
    LineColor Navy
    BackgroundColor #ccf
  }
}
document {
  BackgroundColor transparent
}
</style>
start
:init;
-> test of color;
if (color?) is (<color:red>red) then
:print red;
else
:print not red;
note right: no color
endif
partition End {
:end;
}
-> this is the end;
end
@enduml
```

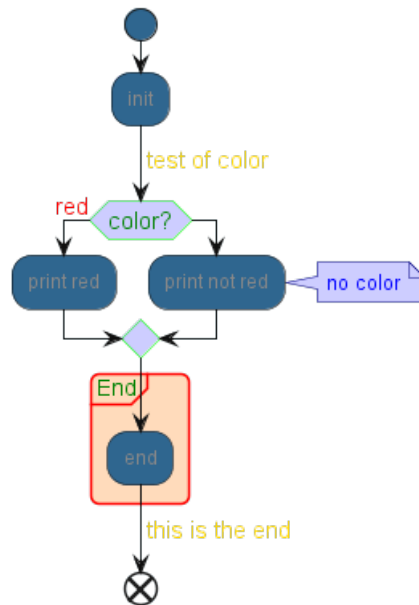

## 7 Component Diagram

**Component Diagram:** A component diagram is a type of structural diagram used in UML (Unified Modeling Language) to visualize the organization and relationships of system components. These diagrams help in breaking down complex systems into manageable components, showcasing their interdependencies, and ensuring efficient system design and architecture.

### Advantages of PlantUML:

- **Simplicity:** With PlantUML, you can create component diagrams using simple and intuitive text-based descriptions, eliminating the need for complex drawing tools.
- **Integration:** PlantUML seamlessly integrates with various tools and platforms, making it a versatile choice for developers and architects.
- **Collaboration:** The PlantUML forum offers a platform for users to discuss, share, and seek assistance on their diagrams, fostering a collaborative community.

### 7.1 Components

Components must be bracketed.

You can also use the `component` keyword to define a component. In this case the brackets can be omitted, but only if the component name does not include white-space or special characters.

You can define an alias, using the `as` keyword. This alias will be used later, when defining relations.

```
@startuml
```

```
[First component]
[Another component] as Comp2
component Comp3
component [Last\ncomponent] as Comp4
```

```
@enduml
```

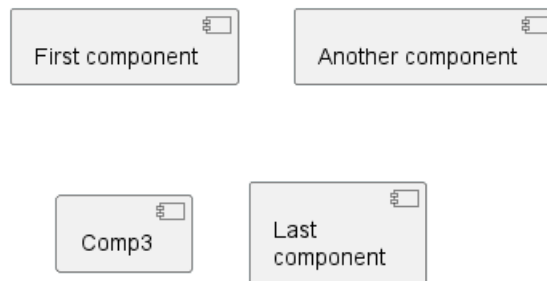

#### 7.1.1 Naming exceptions

Note that component names starting with `$` cannot be hidden or removed later, because `hide` and `remove` command will consider the name a `$tag` instead of a component name. To later remove such component they must have an alias or must be tagged.

```
@startuml
component [$C1]
component [$C2] $C2
component [$C2] as dollarC2
remove $C1
remove $C2
remove dollarC2
@enduml
```

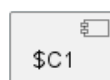

## 7.2 Interfaces

Interface can be defined using the () symbol (because this looks like a circle).

You can also use the `interface` keyword to define an interface. And you can define an alias, using the `as` keyword. This alias will be used latter, when defining relations.

We will see latter that interface definition is optional.

```
@startuml
() "First Interface"
() "Another interface" as Interf2
interface Interf3
interface "Last\ninterface" as Interf4

[component]
footer //Adding "component" to force diagram to be a **component diagram**//
@enduml
```

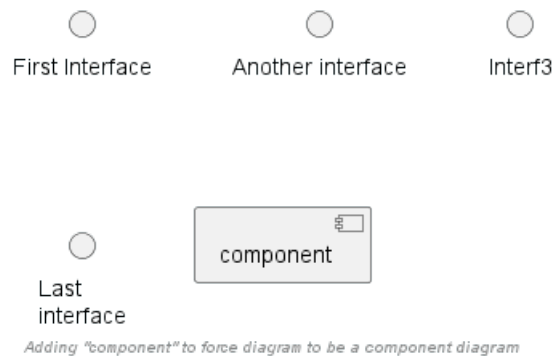

## 7.3 Basic example

Links between elements are made using combinations of dotted line (.), straight line (--), and arrows (-->) symbols.

```
@startuml
DataAccess - [First Component]
[First Component] ..> HTTP : use
@enduml
```

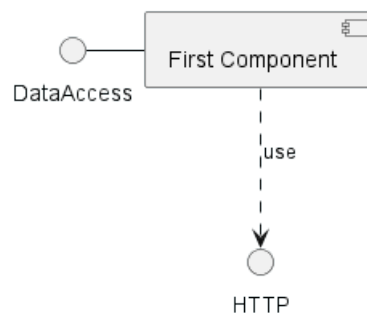

## 7.4 Using notes

You can use the `note left of`, `note right of`, `note top of`, `note bottom of` keywords to define notes related to a single object.

```
@startuml
[Component] as C
```



```

note top of C: A top note

note bottom of C
  A bottom note can also
  be on several lines
end note

note left of C
  A left note can also
  be on several lines
end note

note right of C: A right note
@enduml

```

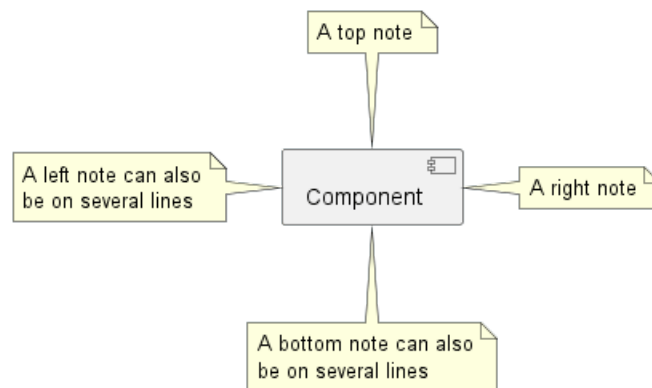

A note can be also defined alone with the `note` keywords, then linked to other objects using the `..` symbol or whatever arrow symbol (`-`, `--`, `...`).

```

@startuml
[Component] as C

note as N
  A floating note can also
  be on several lines
end note

C .. N
@enduml

```

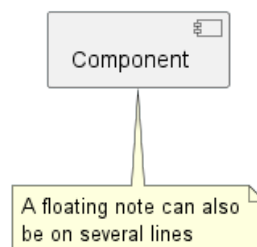

Another note example:

```

@startuml

interface "Data Access" as DA

DA - [First Component]
[First Component] ..> HTTP : use

```

```
note left of HTTP : Web Service only
```

```
note right of [First Component]
```

```
  A note can also
  be on several lines
end note
```

```
@enduml
```

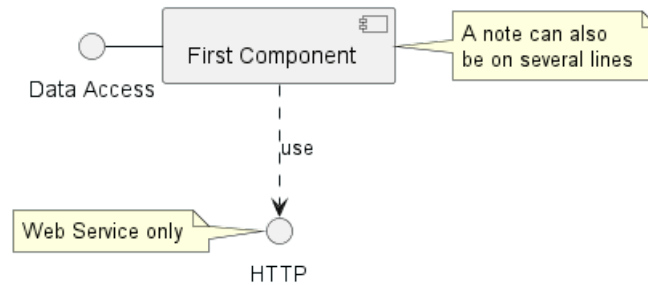

## 7.5 Grouping Components

You can use several keywords to group components and interfaces together:

- package
- node
- folder
- frame
- cloud
- database

```
@startuml
```

```
package "Some Group" {
  HTTP - [First Component]
  [Another Component]
}
```

```
node "Other Groups" {
  FTP - [Second Component]
  [First Component] --> FTP
}
```

```
cloud {
  [Example 1]
}
```

```
database "MySQL" {
  folder "This is my folder" {
    [Folder 3]
  }
  frame "Foo" {
    [Frame 4]
  }
}
```





```

[Another Component] --> [Example 1]
[Example 1] --> [Folder 3]
[Folder 3] --> [Frame 4]

```

```
@enduml
```

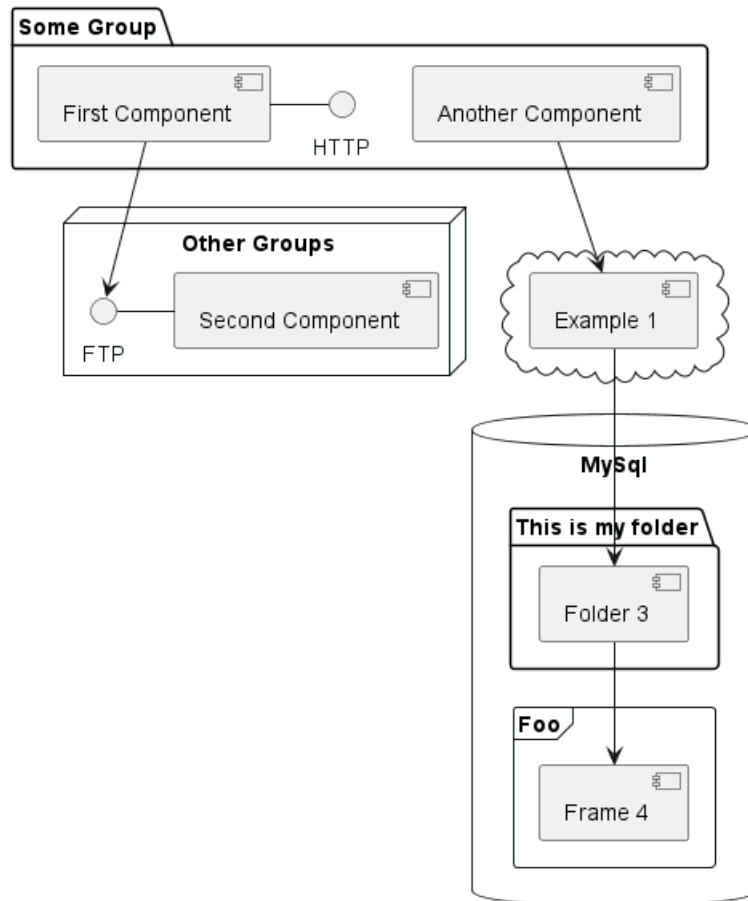

## 7.6 Changing arrows direction

By default, links between classes have two dashes -- and are vertically oriented. It is possible to use horizontal link by putting a single dash (or dot) like this:

```

@startuml
[Component] --> Interface1
[Component] -> Interface2
@enduml

```

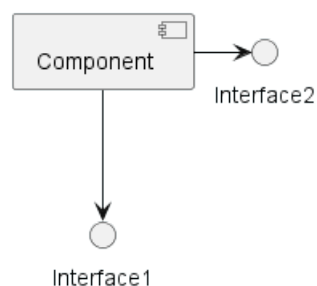

You can also change directions by reversing the link:

```
@startuml
```

```

Interface1 <-- [Component]
Interface2 <- [Component]
@enduml

```

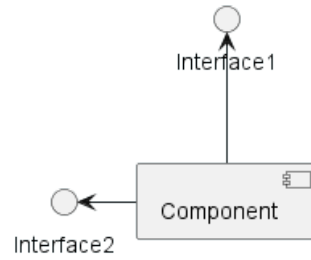

It is also possible to change arrow direction by adding `left`, `right`, `up` or `down` keywords inside the arrow:

```

@startuml
[Component] -left-> left
[Component] -right-> right
[Component] -up-> up
[Component] -down-> down
@enduml

```

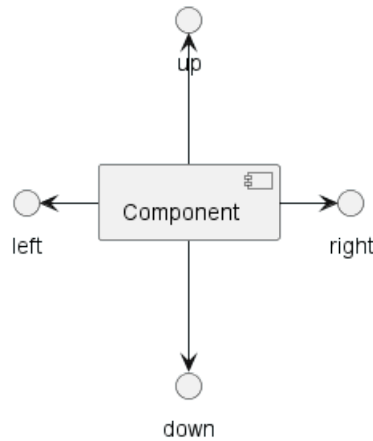

You can shorten the arrow by using only the first character of the direction (for example, `-d-` instead of `-down-`) or the two first characters (`-do-`).

Please note that you should not abuse this functionality : *Graphviz* gives usually good results without tweaking.

And with the `left to right direction` parameter:

```

@startuml
left to right direction
[Component] -left-> left
[Component] -right-> right
[Component] -up-> up
[Component] -down-> down
@enduml

```

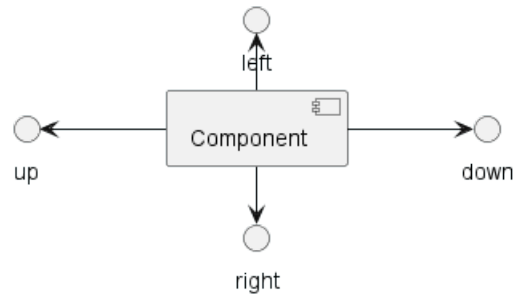

## 7.7 Use UML2 notation

By default (from v1.2020.13-14), UML2 notation is used.

```
@startuml
```

```
interface "Data Access" as DA
```

```
DA - [First Component]
```

```
[First Component] ..> HTTP : use
```

```
@enduml
```

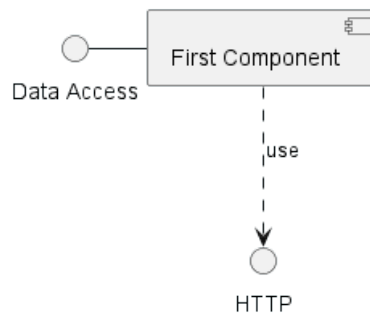

## 7.8 Use UML1 notation

The skinparam componentStyle uml1 command is used to switch to UML1 notation.

```
@startuml
```

```
skinparam componentStyle uml1
```

```
interface "Data Access" as DA
```

```
DA - [First Component]
```

```
[First Component] ..> HTTP : use
```

```
@enduml
```

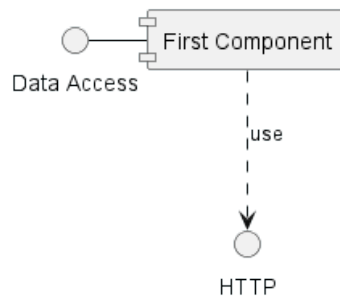

## 7.9 Use rectangle notation (remove UML notation)

The `skinparam componentStyle rectangle` command is used to switch to rectangle notation (*without any UML notation*).

```
@startuml
skinparam componentStyle rectangle

interface "Data Access" as DA

DA - [First Component]
[First Component] ..> HTTP : use

@enduml
```

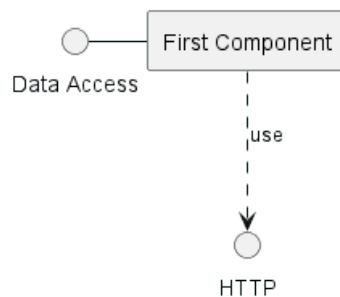

## 7.10 Long description

It is possible to put description on several lines using square brackets.

```
@startuml
component comp1 [
This component
has a long comment
on several lines
]
@enduml
```

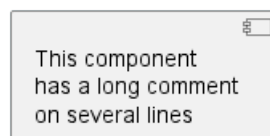

## 7.11 Individual colors

You can specify a color after component definition.

```
@startuml
component [Web Server] #Yellow
@enduml
```



## 7.12 Using Sprite in Stereotype

You can use sprites within stereotype components.

```
@startuml
sprite $businessProcess [16x16/16] {
```



```

FFFFFFFFFFFFFFFF
FFFFFFFFFFFFFFFF
FFFFFFFFFFFFFFFF
FFFFFFFFFFFFFFFF
FFFFFFFFFOFFFF
FFFFFFFFFOFFFF
FF0000000000FF
FF0000000000FF
FF0000000000FF
FFFFFFFFFOFFFF
FFFFFFFFFOFFFF
FFFFFFFFFFFFFFFF
FFFFFFFFFFFFFFFF
FFFFFFFFFFFFFFFF
FFFFFFFFFFFFFFFF
FFFFFFFFFFFFFFFF
}

```

```

rectangle " End to End\nbusiness process" <<$businessProcess>> {
  rectangle "inner process 1" <<$businessProcess>> as src
  rectangle "inner process 2" <<$businessProcess>> as tgt
  src -> tgt
}
@enduml

```

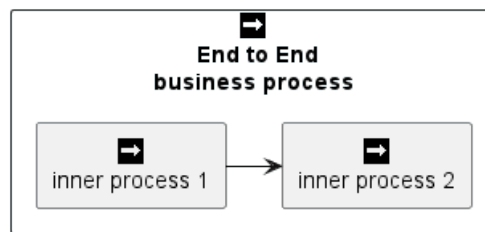

### 7.13 Skinparam

You can use the skinparam command to change colors and fonts for the drawing.

You can use this command :

- In the diagram definition, like any other commands;
- In an included file;
- In a configuration file, provided in the command line or the Ant task.

You can define specific color and fonts for stereotyped components and interfaces.

```
@startuml
```

```

skinparam interface {
  backgroundColor RosyBrown
  borderColor orange
}

```

```

skinparam component {
  FontSize 13
  BackgroundColor<<Apache>> Pink
  BorderColor<<Apache>> #FF6655
  FontName Courier
  BorderColor black
}

```



```

    BackgroundColor gold
    ArrowFontName Impact
    ArrowColor #FF6655
    ArrowFontColor #777777
  }

  () "Data Access" as DA
  Component "Web Server" as WS << Apache >>

  DA - [First Component]
  [First Component] ..> () HTTP : use
  HTTP - WS

@enduml

```

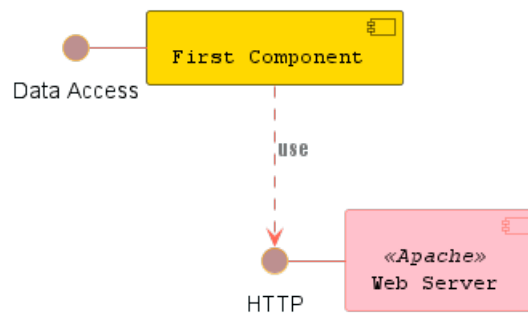

```

@startuml

skinparam component {
  backgroundColor<<static lib>> DarkKhaki
  backgroundColor<<shared lib>> Green
}

skinparam node {
  borderColor Green
  backgroundColor Yellow
  backgroundColor<<shared_node>> Magenta
}
skinparam databaseBackgroundColor Aqua

[AA] <<static lib>>
[BB] <<shared lib>>
[CC] <<static lib>>

node node1
node node2 <<shared_node>>
database Production

@enduml

```

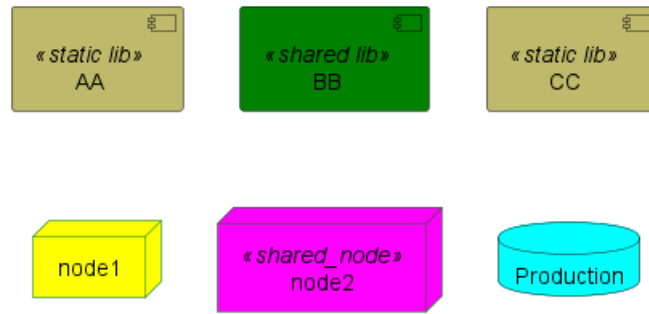

## 7.14 Specific SkinParameter

### 7.14.1 componentStyle

- By default (or with `skinparam componentStyle uml2`), you have an icon for component

```

@startuml
skinparam BackgroundColor transparent
skinparam componentStyle uml2
component A {
  component "A.1" {
  }
  component A.44 {
    [A4.1]
  }
  component "A.2"
  [A.3]
  component A.5 [
A.5]
  component A.6 [
]
}
[a]->[b]
@enduml

```

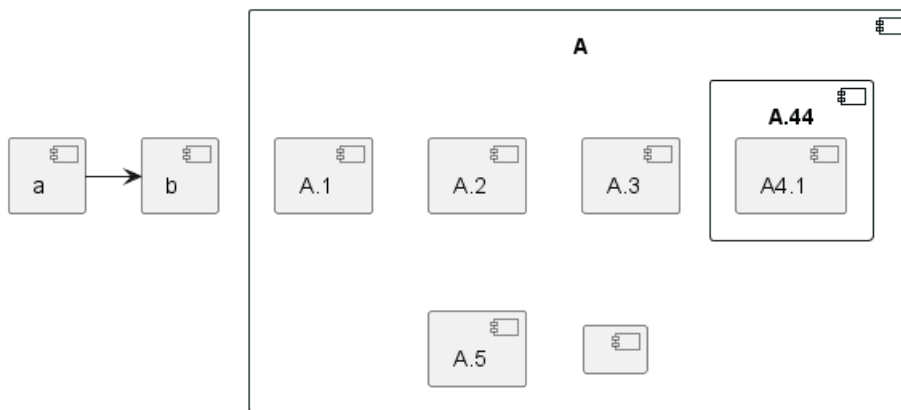

- If you want to suppress it, and to have only the rectangle, you can use `skinparam componentStyle rectangle`

```

@startuml
skinparam BackgroundColor transparent
skinparam componentStyle rectangle
component A {
  component "A.1" {
  }
}
component A.44 {

```



```

    [A4.1]
  }
  component "A.2"
  [A.3]
  component A.5 [
A.5]
  component A.6 [
]
}
[a]->[b]
@enduml

```

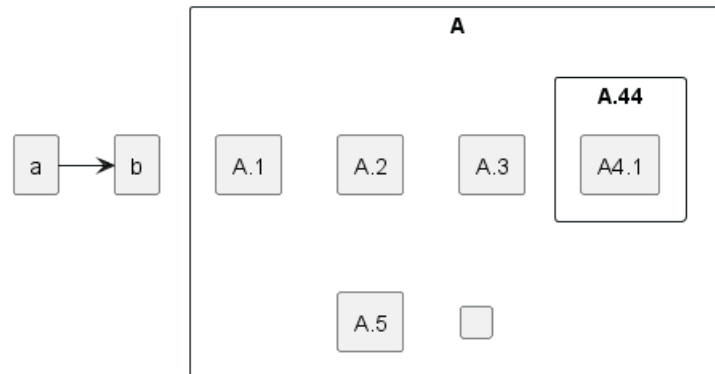

[Ref. 10798]

## 7.15 Hide or Remove unlinked component

By default, all components are displayed:

```

@startuml
component C1
component C2
component C3
C1 -- C2
@enduml

```

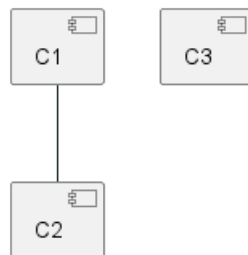

But you can:

- hide @unlinked components:

```

@startuml
component C1
component C2
component C3
C1 -- C2

hide @unlinked
@enduml

```







- or remove @unlinked components:

```

@startuml
component C1
component C2
component C3
C1 -- C2

remove @unlinked
@enduml
  
```



[Ref. QA-11052]

## 7.16 Hide, Remove or Restore tagged component or wildcard

You can put \$tags (using \$) on components, then remove, hide or restore components either individually or by tags.

By default, all components are displayed:

```

@startuml
component C1 $tag13
component C2
component C3 $tag13
C1 -- C2
@enduml
  
```

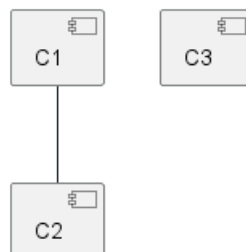

But you can:

- hide \$tag13 components:

```

@startuml
component C1 $tag13
component C2
component C3 $tag13
  
```



```
C1 -- C2
```

```
hide $tag13
@enduml
```



- or remove \$tag13 components:

```
@startuml
component C1 $tag13
component C2
component C3 $tag13
C1 -- C2
@enduml
```

```
remove $tag13
@enduml
```



- or remove \$tag13 and restore \$tag1 components:

```
@startuml
component C1 $tag13 $tag1
component C2
component C3 $tag13
C1 -- C2
@enduml
```

```
remove $tag13
restore $tag1
@enduml
```



- or remove \* and restore \$tag1 components:

```
@startuml
component C1 $tag13 $tag1
component C2
component C3 $tag13
C1 -- C2
@enduml
```

```
remove *
restore $tag1
@enduml
```



[Ref. QA-7337 and QA-11052]

## 7.17 Display JSON Data on Component diagram

### 7.17.1 Simple example

```
@startuml
allowmixing

component Component
()      Interface

json JSON {
  "fruit": "Apple",
  "size": "Large",
  "color": ["Red", "Green"]
}
@enduml
```

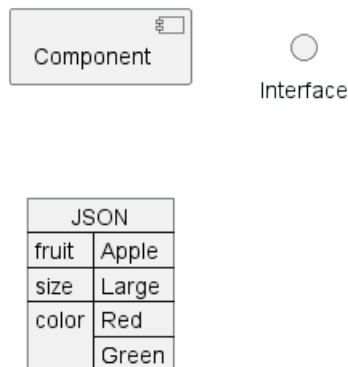

[Ref. QA-15481]

For another example, see on JSON page.

## 7.18 Port [port, portIn, portOut]

You can add **port** with `port`, `portin` and `portout` keywords.

### 7.18.1 Port

```
@startuml
[c]
component C {
  port p1
  port p2
  port p3
  component c1
}

c --> p1
c --> p2
c --> p3
p1 --> c1
p2 --> c1
@enduml
```



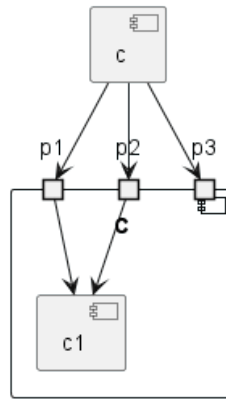

### 7.18.2 PortIn

```

@startuml
[c]
component C {
  portin p1
  portin p2
  portin p3
  component c1
}
  
```

```

c --> p1
c --> p2
c --> p3
p1 --> c1
p2 --> c1
@enduml
  
```

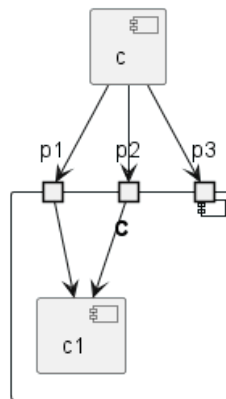

### 7.18.3 PortOut

```

@startuml
component C {
  portout p1
  portout p2
  portout p3
  component c1
}
  
```

```

[o]
p1 --> o
p2 --> o
p3 --> o
  
```



```
c1 --> p1
@enduml
```

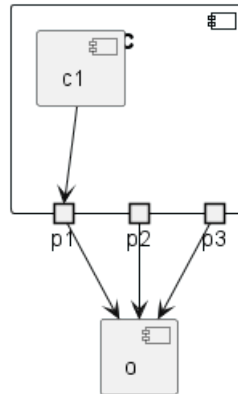

#### 7.18.4 Mixing PortIn & PortOut

```
@startuml
[i]
component C {
  portin p1
  portin p2
  portin p3
  portout po1
  portout po2
  portout po3
  component c1
}
[o]

i --> p1
i --> p2
i --> p3
p1 --> c1
p2 --> c1
po1 --> o
po2 --> o
po3 --> o
c1 --> po1
@enduml
```

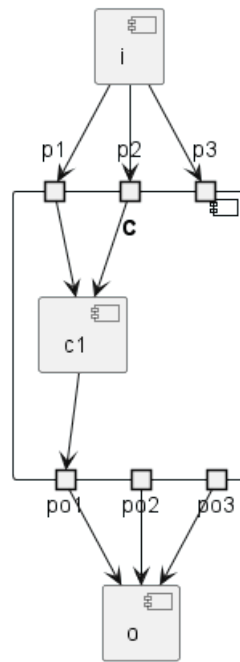

## 8 Deployment Diagram

A **Deployment Diagram** is a type of diagram that visualizes the architecture of systems, showcasing how software components are deployed onto hardware. It provides a clear picture of the distribution of components across various nodes, such as servers, workstations, and devices.

With PlantUML, creating deployment diagrams becomes a breeze. The platform offers a simple and intuitive way to design these diagrams using plain text, ensuring rapid iterations and easy version control. Moreover, the PlantUML forum provides a vibrant community where users can seek help, share ideas, and collaborate on diagramming challenges. One of the key advantages of PlantUML is its ability to integrate seamlessly with various tools and platforms, making it a preferred choice for professionals and enthusiasts alike.

### 8.1 Declaring element

```
@startuml
actor actor
actor/ "actor/"
agent agent
artifact artifact
boundary boundary
card card
circle circle
cloud cloud
collections collections
component component
control control
database database
entity entity
file file
folder folder
frame frame
hexagon hexagon
interface interface
label label
node node
package package
person person
queue queue
rectangle rectangle
stack stack
storage storage
usecase usecase
usecase/ "usecase/"
@enduml
```



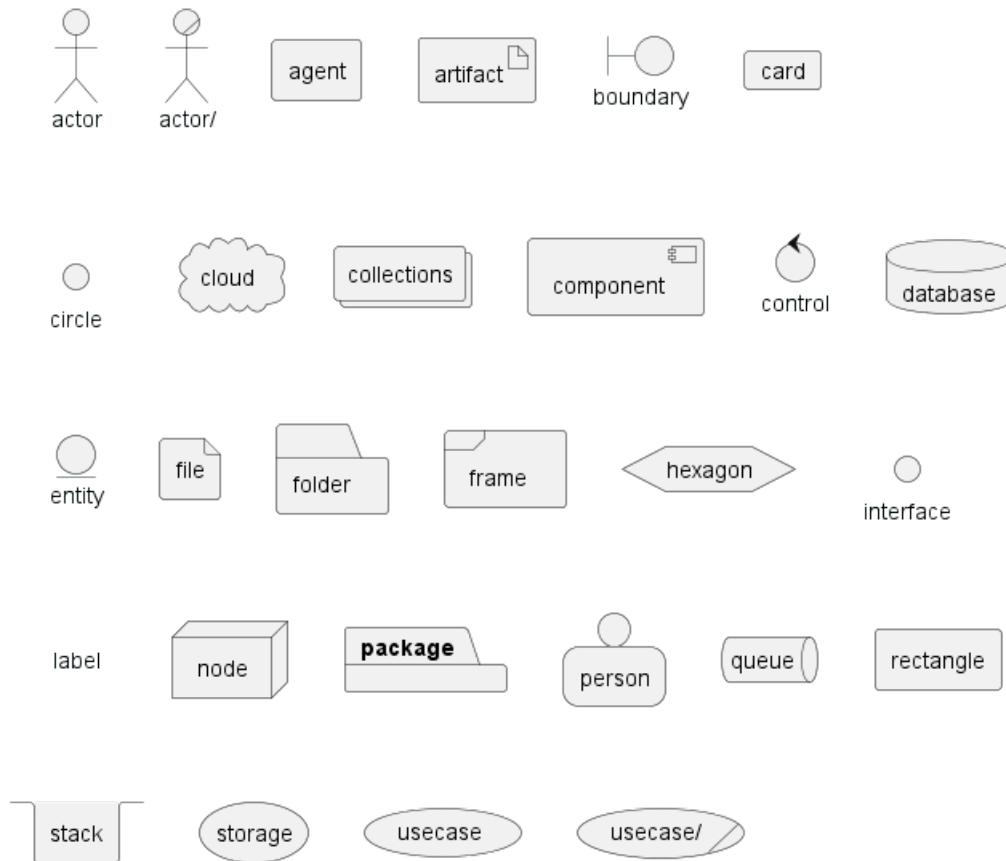

You can optionally put text using bracket `[]` for a long description.

```

@startuml
folder folder [
This is a <b>folder
----
You can use separator
====
of different kind
....
and style
]

node node [
This is a <b>node
----
You can use separator
====
of different kind
....
and style
]

database database [
This is a <b>database
----
You can use separator
====
of different kind
....
and style

```





```

]

usecase usecase [
This is a <b>usecase
----
You can use separator
====
of different kind
....
and style
]

card card [
This is a <b>card
----
You can use separator
====
of different kind
....
and style
<i><color:blue>(add from V1.2020.7)</color></i>
]
@enduml

```

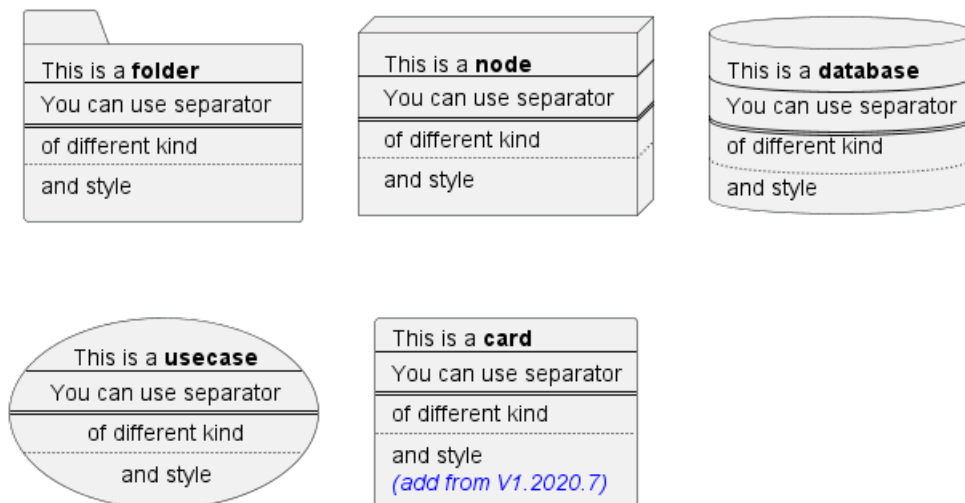

## 8.2 Declaring element (using short form)

We can declare element using some short forms.

Long form Keyword	Short form Keyword	Long form example	Short form example	Ref.
actor	: a :	actor actor1	:actor2:	Actors
component	[ c ]	component component1	[component2]	Components
interface	() i	interface interface1	() "interface2"	Interfaces
usecase	( u )	usecase usecase1	(usecase2)	Usecases

### 8.2.1 Actor

```

@startuml

actor actor1
:actor2:

@enduml

```



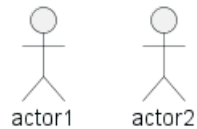

**NB:** *There is an old syntax for actor with guillemet which is now deprecated and will be removed some days. Please do not use in your diagram.*

### 8.2.2 Component

```

@startuml
component component1
[component2]
@enduml
  
```



### 8.2.3 Interface

```

@startuml
interface interface1
() "interface2"
label "//interface example//"
@enduml
  
```



*interface example*

### 8.2.4 Usecase

```

@startuml
usecase usecase1
(usecase2)
@enduml
  
```



## 8.3 Linking or arrow

You can create simple links between elements with or without labels:

```

@startuml
node node1
node node2
node node3
node node4
  
```



```

node node5
node1 -- node2 : label1
node1 .. node3 : label2
node1 ~~ node4 : label3
node1 == node5

@enduml

```

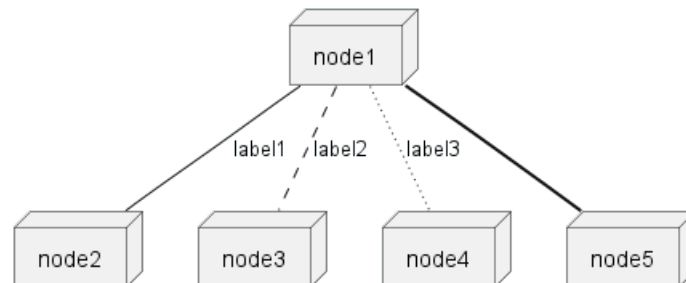

It is possible to use several types of links:

```

@startuml

artifact artifact1
artifact artifact2
artifact artifact3
artifact artifact4
artifact artifact5
artifact artifact6
artifact artifact7
artifact artifact8
artifact artifact9
artifact artifact10
artifact1 --> artifact2
artifact1 --* artifact3
artifact1 --o artifact4
artifact1 --+ artifact5
artifact1 --# artifact6
artifact1 -->> artifact7
artifact1 --0 artifact8
artifact1 --^ artifact9
artifact1 --(0 artifact10

@enduml

```

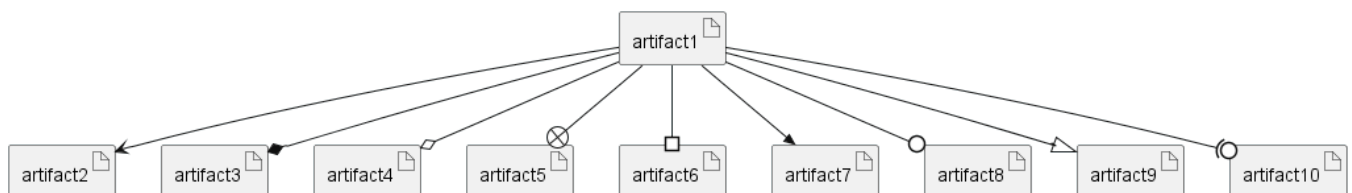

You can also have the following types:

```

@startuml

cloud cloud1
cloud cloud2
cloud cloud3
cloud cloud4

```



```

cloud cloud5
cloud1 -0- cloud2
cloud1 -0)- cloud3
cloud1 -(0- cloud4
cloud1 -(0)- cloud5

@enduml

```

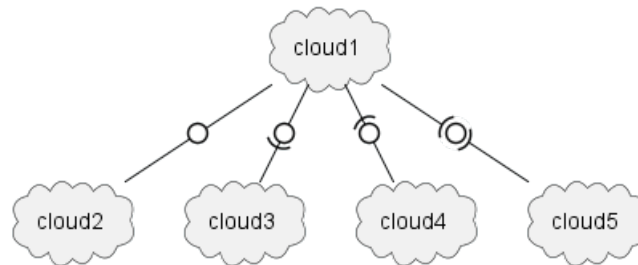

or another example:

```

@startuml
actor foo1
actor foo2
foo1 <-0-> foo2
foo1 <-(0)-> foo2

(ac1) -le(0)-> left1
ac1 -ri(0)-> right1
ac1 .up(0).> up1
ac1 ~up(0)~> up2
ac1 -do(0)-> down1
ac1 -do(0)-> down2

actor1 -0)- actor2

component comp1
component comp2
comp1 *-0)-+ comp2
[comp3] <-->> [comp4]

boundary b1
control c1
b1 -(0)- c1

component comp1
interface interf1
comp1 #~-( interf1

:modelactor: -0)- fooa1
:modelactor1: -ri0)- foo11

[component1] 0)-(0-(0 [componentC]
() component3 )-0-(0 "foo" [componentC]

[aze1] #-->> [aze2]
@enduml

```

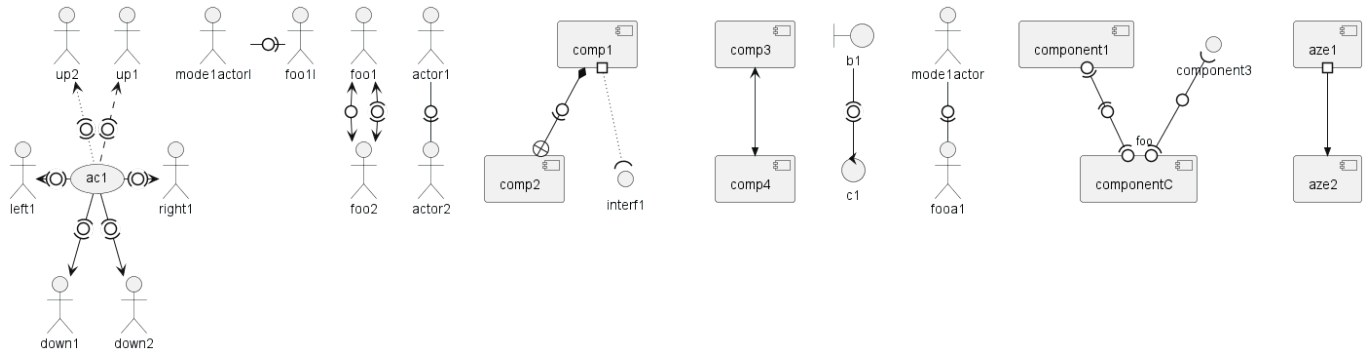

[Ref. QA-547 and QA-1736]

See all type on **Appendix**.

## 8.4 Bracketed arrow style

Similar as Bracketed **class** relations (linking or arrow) style

### 8.4.1 Line style

It's also possible to have explicitly bold, dashed, dotted, hidden or plain arrows:

- without label

```
@startuml
node foo
title Bracketed line style without label
foo --> bar
foo -[bold]-> bar1
foo -[dashed]-> bar2
foo -[dotted]-> bar3
foo -[hidden]-> bar4
foo -[plain]-> bar5
@enduml
```

**Bracketed line style without label**

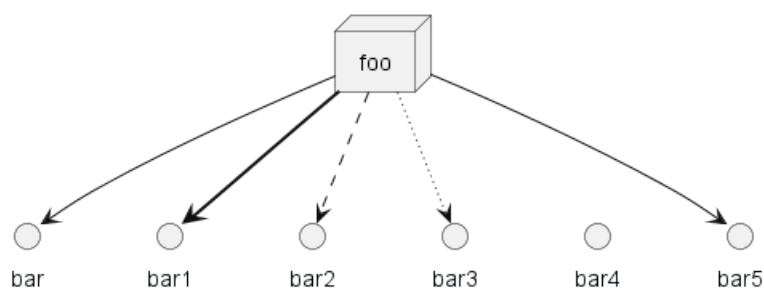

- with label

```
@startuml
title Bracketed line style with label
node foo
foo --> bar :
foo -[bold]-> bar1 : [bold]
foo -[dashed]-> bar2 : [dashed]
foo -[dotted]-> bar3 : [dotted]
foo -[hidden]-> bar4 : [hidden]
foo -[plain]-> bar5 : [plain]
@enduml
```



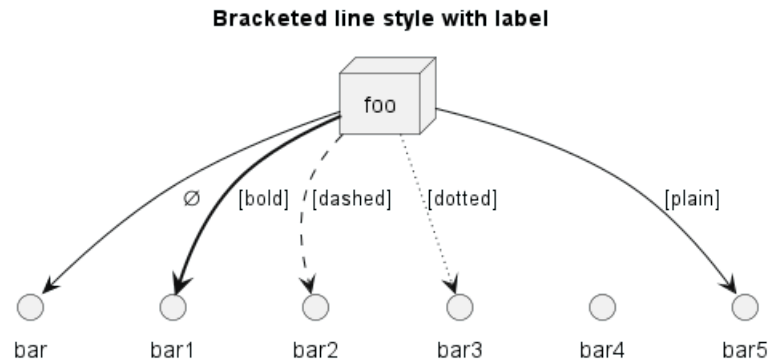

[Adapted from QA-4181]

### 8.4.2 Line color

```
@startuml
title Bracketed line color
node foo
foo --> bar
foo -[#red]-> bar1 : [#red]
foo -[#green]-> bar2 : [#green]
foo -[#blue]-> bar3 : [#blue]
foo -[#blue;#yellow;#green]-> bar4
@enduml
```

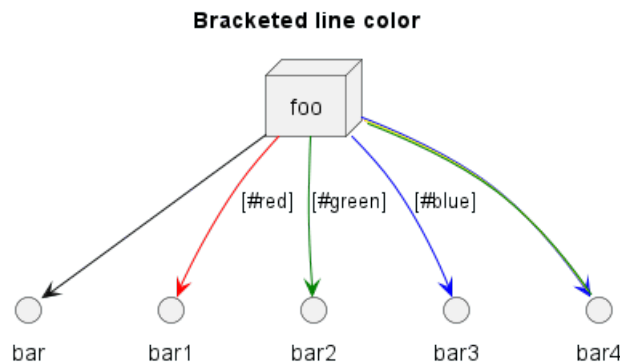

### 8.4.3 Line thickness

```
@startuml
title Bracketed line thickness
node foo
foo --> bar :
foo -[thickness=1]-> bar1 : [1]
foo -[thickness=2]-> bar2 : [2]
foo -[thickness=4]-> bar3 : [4]
foo -[thickness=8]-> bar4 : [8]
foo -[thickness=16]-> bar5 : [16]
@enduml
```

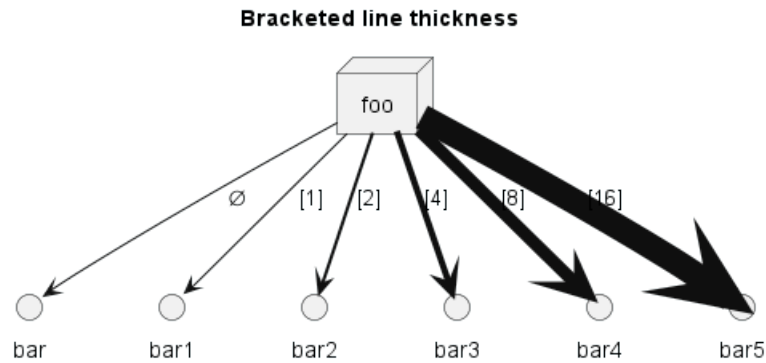

[Adapted from QA-4949]

#### 8.4.4 Mix

```
@startuml
title Bracketed line style mix
node foo
foo --> bar : 
foo -[#red,thickness=1]-> bar1 : [#red,1]
foo -[#red,dashed,thickness=2]-> bar2 : [#red,dashed,2]
foo -[#green,dashed,thickness=4]-> bar3 : [#green,dashed,4]
foo -[#blue,dotted,thickness=8]-> bar4 : [blue,dotted,8]
foo -[#blue,plain,thickness=16]-> bar5 : [blue,plain,16]
foo -[#blue;#green,dashed,thickness=4]-> bar6 : [blue;green,dashed,4]
@enduml
```

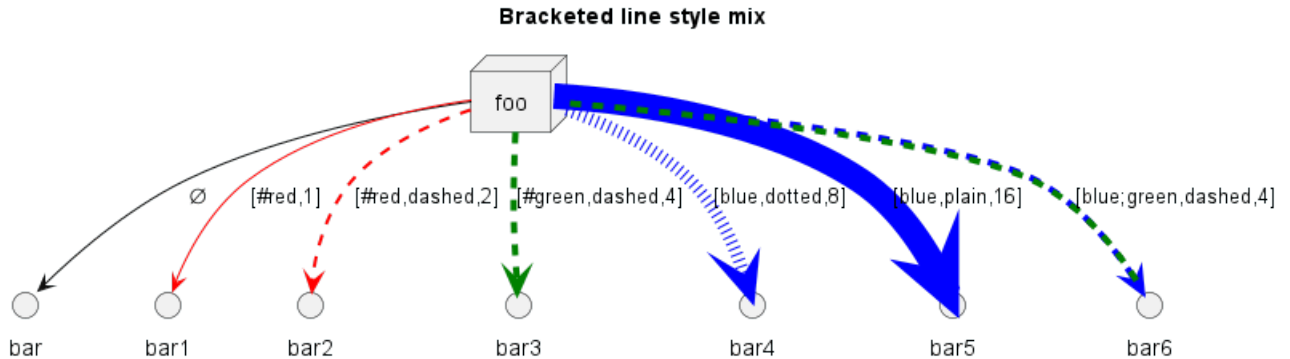

## 8.5 Change arrow color and style (inline style)

You can change the color or style of individual arrows using the inline following notation:

- #color;line.[bold|dashed|dotted];text:color

```
@startuml
node foo
foo --> bar : normal
foo --> bar1 #line:red;line.bold;text:red : red bold
foo --> bar2 #green;line.dashed;text:green : green dashed
foo --> bar3 #blue;line.dotted;text:blue : blue dotted
@enduml
```

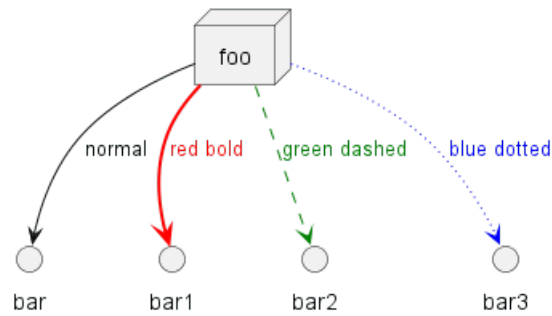

[Ref. QA-3770 and QA-3816] [See similar feature on class diagram]

## 8.6 Change element color and style (inline style)

You can change the color or style of individual element using the following notation:

- `#[color|back:color];line:color;line.[bold|dashed|dotted];text:color`

```
@startuml
agent a
cloud c #pink;line:red;line.bold;text:red
file f #palegreen;line:green;line.dashed;text:green
node n #aliceblue;line:blue;line.dotted;text:blue
@enduml
```

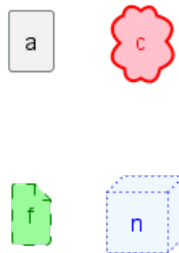

```
@startuml
agent a
cloud c #pink;line:red;line.bold;text:red [
c
cloud description
]
file f #palegreen;line:green;line.dashed;text:green {
[c1]
[c2]
}
frame frame {
node n #aliceblue;line:blue;line.dotted;text:blue
}
@enduml
```

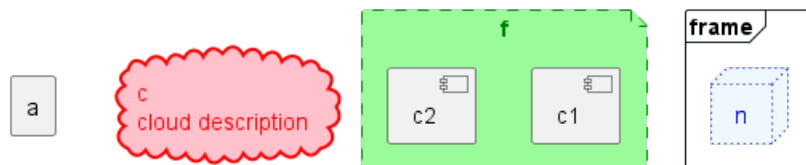

[Ref. QA-6852]



## 8.7 Nestable elements

Here are the nestable elements:

```

@startuml
artifact artifact {
}
card card {
}
cloud cloud {
}
component component {
}
database database {
}
file file {
}
folder folder {
}
frame frame {
}
hexagon hexagon {
}
node node {
}
package package {
}
queue queue {
}
rectangle rectangle {
}
stack stack {
}
storage storage {
}
@enduml

```



## 8.8 Packages and nested elements

### 8.8.1 Example with one level

```

@startuml
artifact      artifactVeryL00000000000000000000g      as "artifact" {
file f1
}
card         cardVeryL00000000000000000000g         as "card" {
file f2
}
cloud       cloudVeryL00000000000000000000g         as "cloud" {
file f3
}
component   componentVeryL00000000000000000000g     as "component" {
file f4
}
database    databaseVeryL00000000000000000000g      as "database" {
file f5
}

```



```

}
file      fileVeryL0000000000000000000g      as "file" {
file f6
}
folder    folderVeryL0000000000000000000g    as "folder" {
file f7
}
frame     frameVeryL0000000000000000000g     as "frame" {
file f8
}
hexagon   hexagonVeryL0000000000000000000g   as "hexagon" {
file f9
}
node      nodeVeryL0000000000000000000g      as "node" {
file f10
}
package   packageVeryL0000000000000000000g   as "package" {
file f11
}
queue     queueVeryL0000000000000000000g     as "queue" {
file f12
}
rectangle rectangleVeryL0000000000000000000g as "rectangle" {
file f13
}
stack     stackVeryL0000000000000000000g     as "stack" {
file f14
}
storage   storageVeryL0000000000000000000g   as "storage" {
file f15
}
@enduml

```

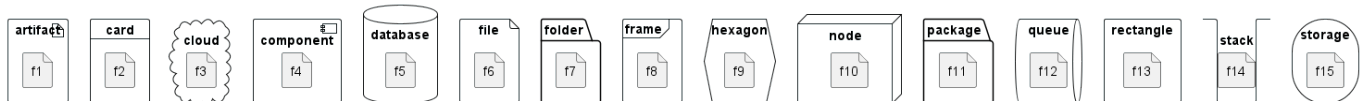

### 8.8.2 Other example

```

@startuml
artifact Foo1 {
  folder Foo2
}

folder Foo3 {
  artifact Foo4
}

frame Foo5 {
  database Foo6
}

cloud vpc {
  node ec2 {
    stack stack
  }
}

```



```
@enduml
```

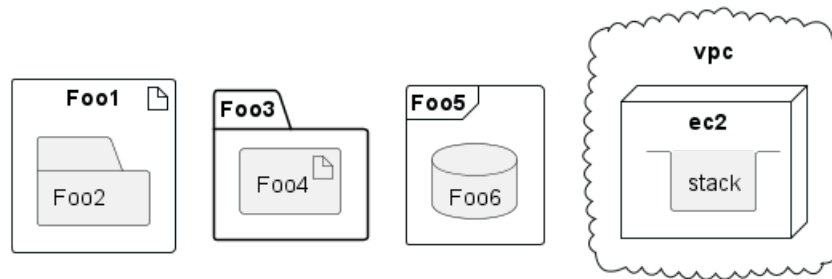

```
@startuml
node Foo1 {
  cloud Foo2
}

cloud Foo3 {
  frame Foo4
}

database Foo5 {
  storage Foo6
}

storage Foo7 {
  storage Foo8
}
@enduml
```

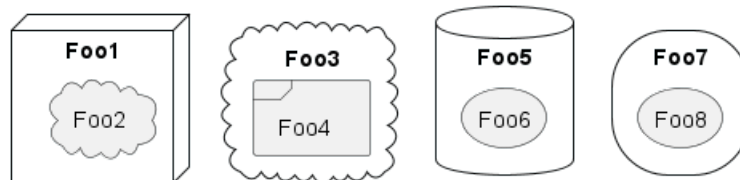

### 8.8.3 Full nesting

Here is all the nested elements:

- by alphabetical order:

```
@startuml
artifact artifact {
  card card {
  cloud cloud {
  component component {
  database database {
  file file {
  folder folder {
  frame frame {
  hexagon hexagon {
  node node {
  package package {
  queue queue {
  rectangle rectangle {
  stack stack {
  storage storage {
```



```
}  
}  
}  
}  
}  
}  
}  
}  
}  
}  
}  
}  
}  
}  
}  
}  
}  
}  
}  
}  
}  
@enduml
```

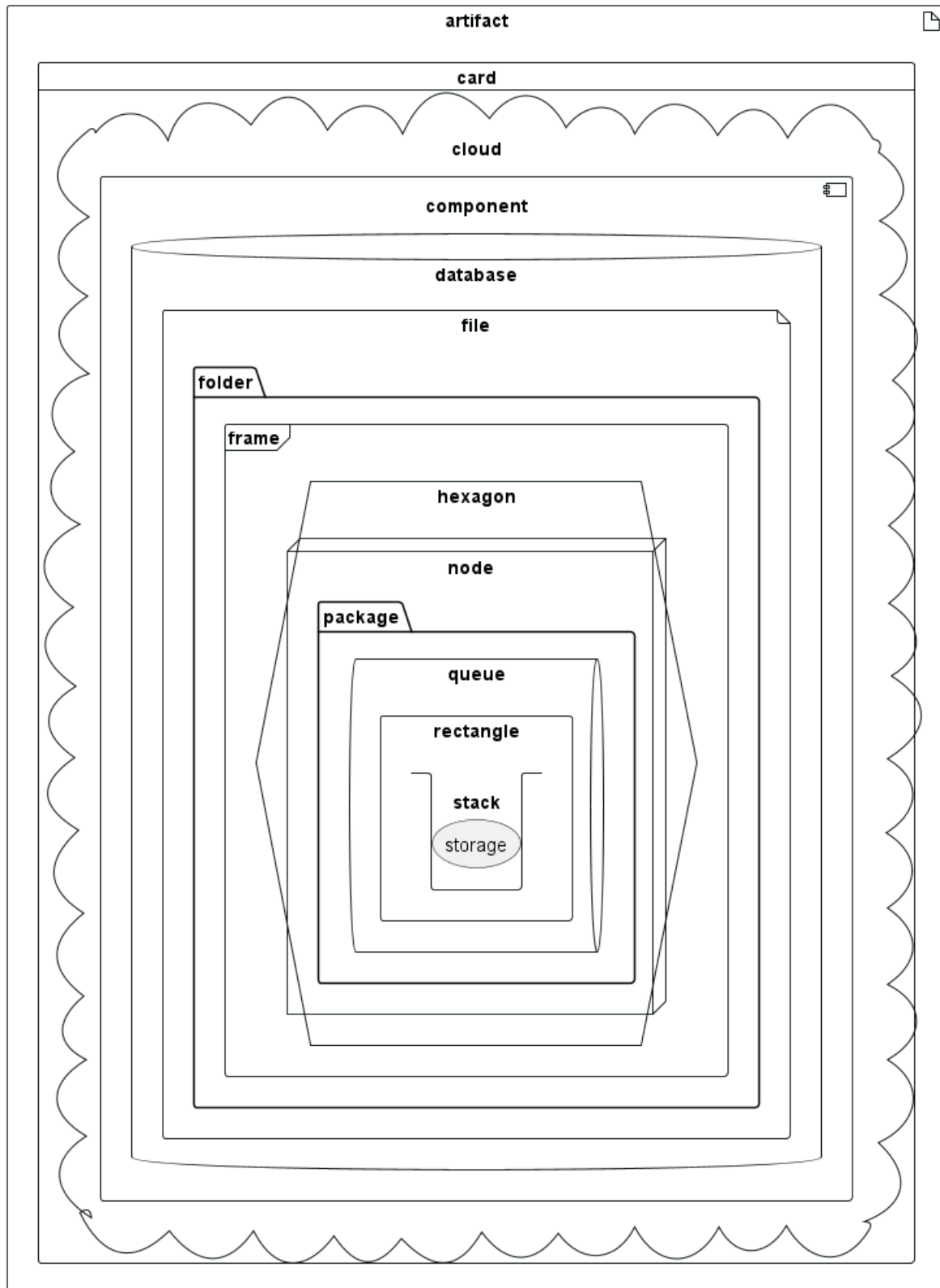

- or reverse alphabetical order

```

@startuml
storage storage {
stack stack {
rectangle rectangle {
queue queue {
package package {

```

```
node node {  
  hexagon hexagon {  
    frame frame {  
      folder folder {  
        file file {  
          database database {  
            component component {  
              cloud cloud {  
                card card {  
                  artifact artifact {  
                }  
              }  
            }  
          }  
        }  
      }  
    }  
  }  
}  
@enduml
```

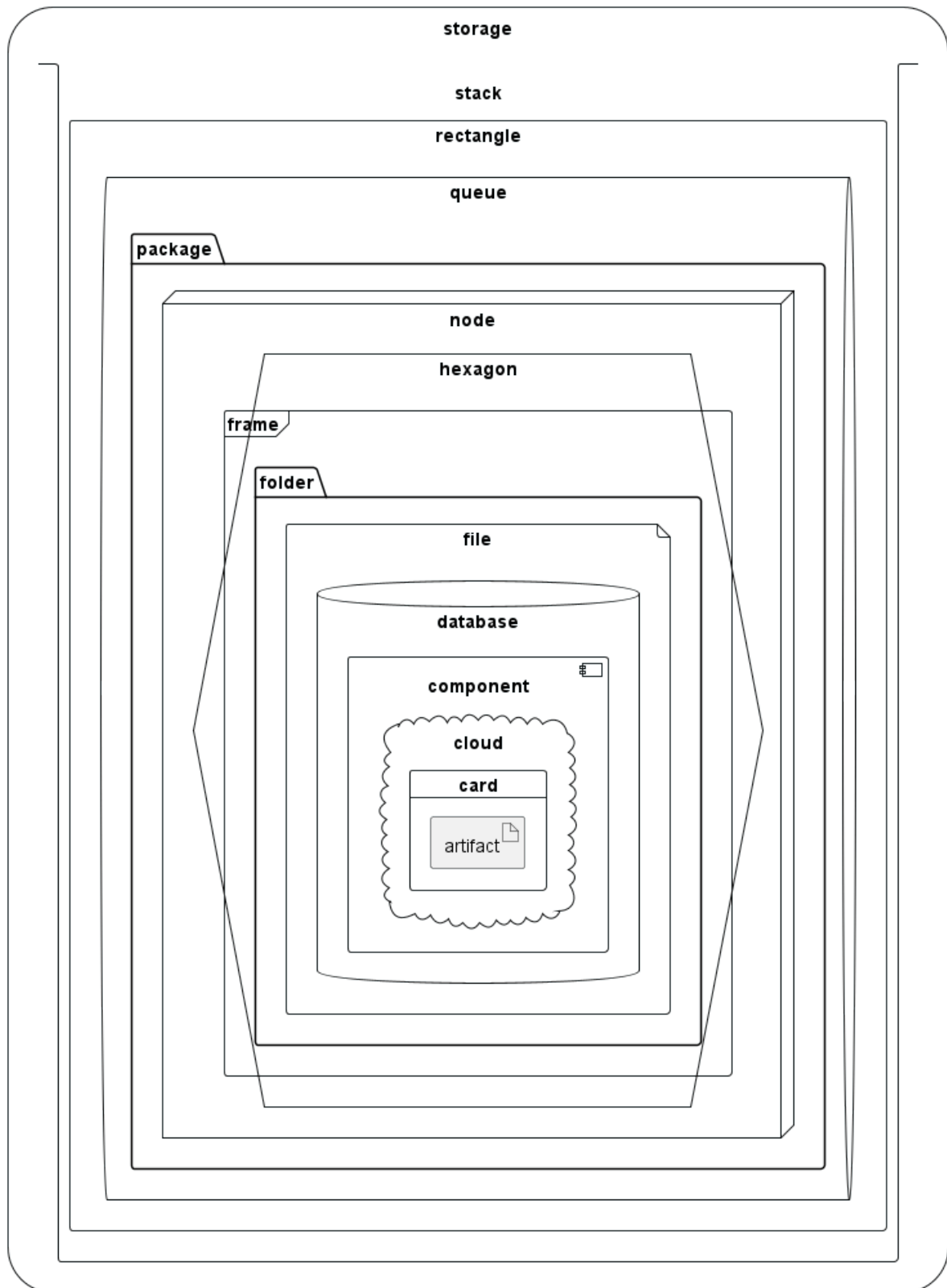

## 8.9 Alias

### 8.9.1 Simple alias with as

```
@startuml
node Node1 as n1
node "Node 2" as n2
```



```

file f1 as "File 1"
cloud c1 as "this
is
a
cloud"
cloud c2 [this
is
another
cloud]

n1 -> n2
n1 --> f1
f1 -> c1
c1 -> c2
@enduml

```

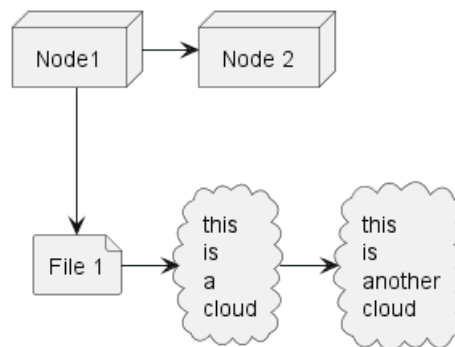

### 8.9.2 Examples of long alias

```

@startuml
actor      "actor"      as actorVeryL0000000000000000000g
agent      "agent"      as agentVeryL0000000000000000000g
artifact   "artifact"   as artifactVeryL0000000000000000000g
boundary   "boundary"   as boundaryVeryL0000000000000000000g
card        "card"       as cardVeryL0000000000000000000g
cloud      "cloud"      as cloudVeryL0000000000000000000g
collections "collections" as collectionsVeryL0000000000000000000g
component  "component"  as componentVeryL0000000000000000000g
control     "control"    as controlVeryL0000000000000000000g
database    "database"   as databaseVeryL0000000000000000000g
entity      "entity"     as entityVeryL0000000000000000000g
file        "file"       as fileVeryL0000000000000000000g
folder      "folder"     as folderVeryL0000000000000000000g
frame       "frame"      as frameVeryL0000000000000000000g
hexagon     "hexagon"    as hexagonVeryL0000000000000000000g
interface   "interface"  as interfaceVeryL0000000000000000000g
label       "label"      as labelVeryL0000000000000000000g
node        "node"       as nodeVeryL0000000000000000000g
package     "package"    as packageVeryL0000000000000000000g
person      "person"     as personVeryL0000000000000000000g
queue       "queue"      as queueVeryL0000000000000000000g
stack       "stack"      as stackVeryL0000000000000000000g
rectangle   "rectangle"  as rectangleVeryL0000000000000000000g
storage     "storage"    as storageVeryL0000000000000000000g
usecase     "usecase"    as usecaseVeryL0000000000000000000g
@enduml

```



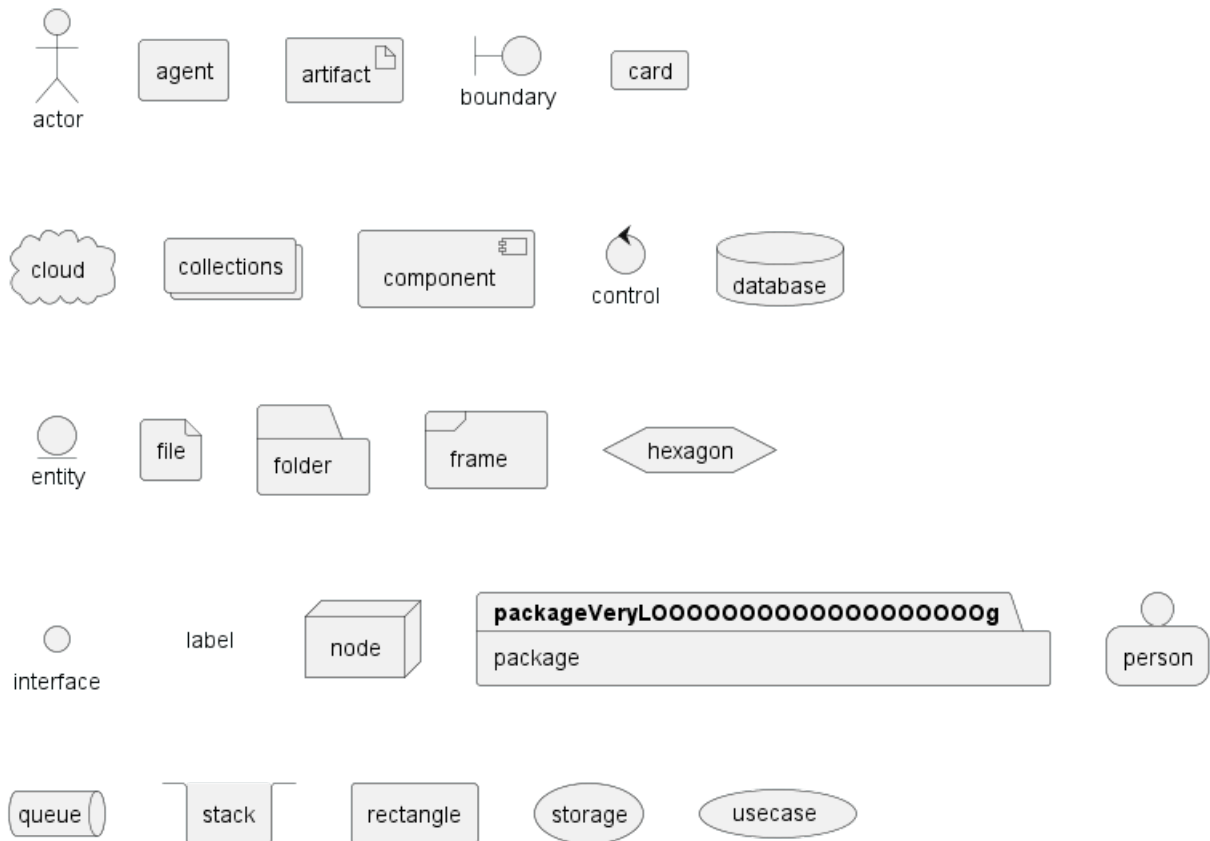

```

@startuml
actor      actorVeryL00000000000000000000g      as "actor"
agent      agentVeryL00000000000000000000g      as "agent"
artifact   artifactVeryL00000000000000000000g  as "artifact"
boundary   boundaryVeryL00000000000000000000g  as "boundary"
card       cardVeryL00000000000000000000g      as "card"
cloud      cloudVeryL00000000000000000000g     as "cloud"
collections collectionsVeryL00000000000000000000g as "collections"
component  componentVeryL00000000000000000000g as "component"
control    controlVeryL00000000000000000000g  as "control"
database   databaseVeryL00000000000000000000g  as "database"
entity     entityVeryL00000000000000000000g    as "entity"
file       fileVeryL00000000000000000000g     as "file"
folder     folderVeryL00000000000000000000g    as "folder"
frame      frameVeryL00000000000000000000g     as "frame"
hexagon    hexagonVeryL00000000000000000000g   as "hexagon"
interface  interfaceVeryL00000000000000000000g as "interface"
label      labelVeryL00000000000000000000g    as "label"
node       nodeVeryL00000000000000000000g     as "node"
package    packageVeryL00000000000000000000g   as "package"
person     personVeryL00000000000000000000g    as "person"
queue      queueVeryL00000000000000000000g    as "queue"
stack      stackVeryL00000000000000000000g    as "stack"
rectangle  rectangleVeryL00000000000000000000g as "rectangle"
storage    storageVeryL00000000000000000000g  as "storage"
usecase    usecaseVeryL00000000000000000000g  as "usecase"
@enduml
    
```

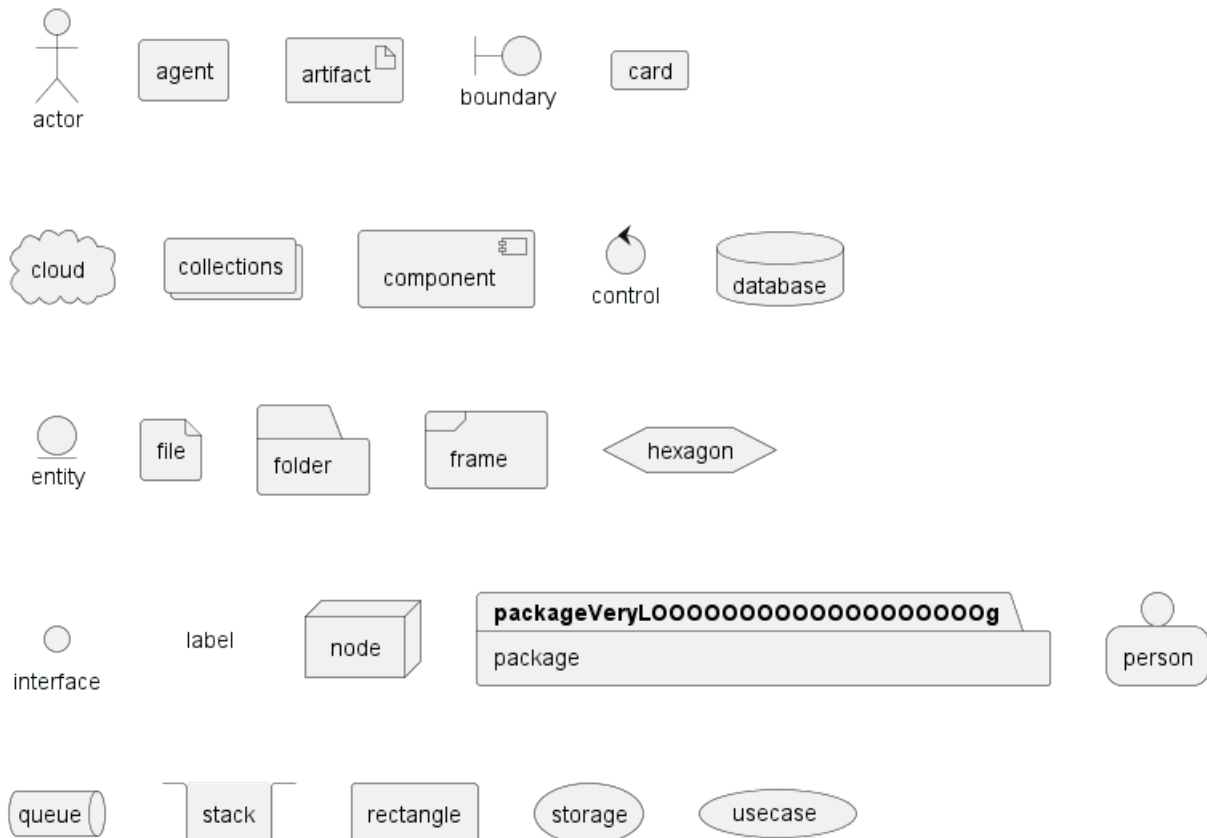

[Ref. QA-12082]

## 8.10 Round corner

```

@startuml
skinparam rectangle {
    roundCorner<<Concept>> 25
}

rectangle "Concept Model" <<Concept>> {
    rectangle "Example 1" <<Concept>> as ex1
    rectangle "Another rectangle"
}
@enduml

```

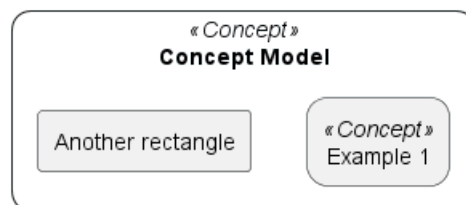

## 8.11 Specific SkinParameter

### 8.11.1 roundCorner

```

@startuml
skinparam roundCorner 15
actor actor
agent agent
artifact artifact

```



```

boundary boundary
card card
circle circle
cloud cloud
collections collections
component component
control control
database database
entity entity
file file
folder folder
frame frame
hexagon hexagon
interface interface
label label
node node
package package
person person
queue queue
rectangle rectangle
stack stack
storage storage
usecase usecase
@enduml

```

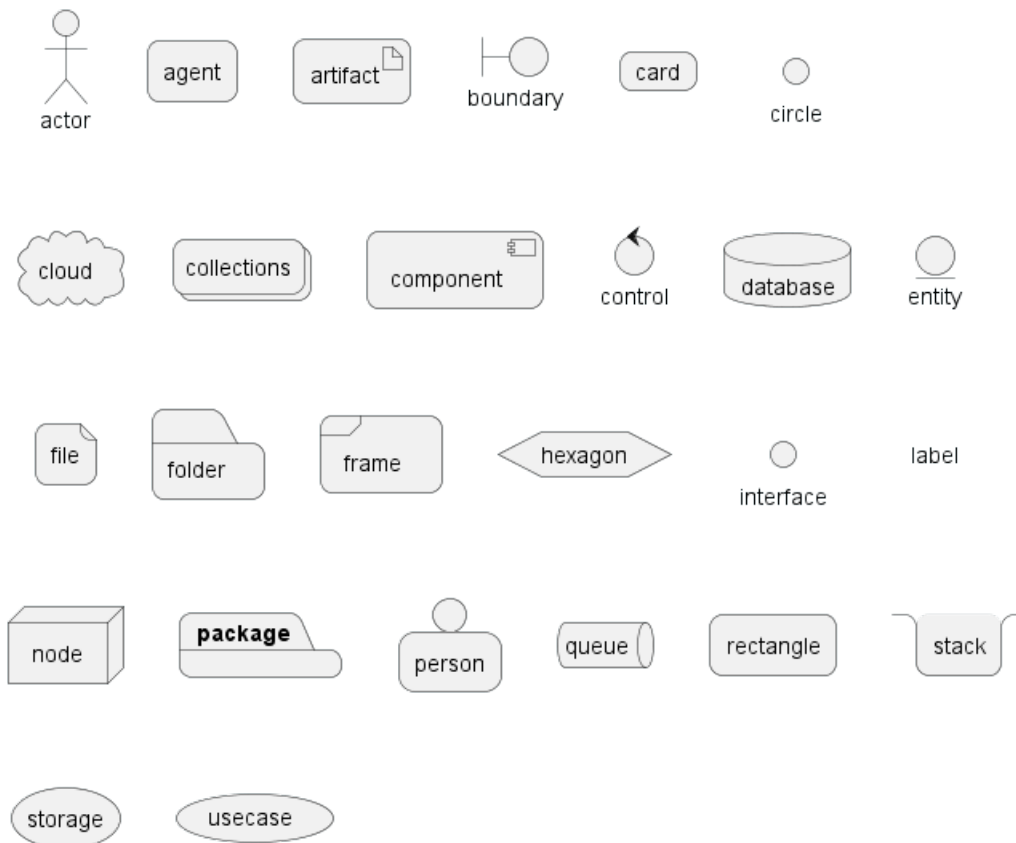

[Ref. QA-5299, QA-6915, QA-11943]

## 8.12 Appendix: All type of arrow line

```

@startuml
left to right direction
skinparam nodesep 5

```

```

f3 ~~ b3 : ""~~""\n//dotted//
f2 .. b2 : ""..""\n//dashed//
f1 == b1 : ""==""\n//bold//
f0 -- b0 : ""--""\n//plain//
@enduml

```

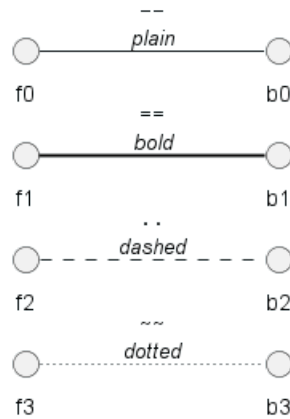

## 8.13 Appendix: All type of arrow head or '0' arrow

### 8.13.1 Type of arrow head

```

@startuml
left to right direction
skinparam nodesep 5

f13 --0 b13 : ""--0""
f12 --@ b12 : ""--@"
f11 --:|> b11 : ""--:|>""
f10 --||> b10 : ""--||>""
f9 --|> b9 : ""--|>""
f8 --^ b8 : ""--^ ""
f7 --\\ b7 : ""--\\\\"
f6 --# b6 : ""--# ""
f5 --+ b5 : ""--+ ""
f4 --o b4 : ""--o ""
f3 --* b3 : ""--* ""
f2 -->> b2 : ""-->>""
f1 --> b1 : ""--> ""
f0 -- b0 : ""-- ""
@enduml

```

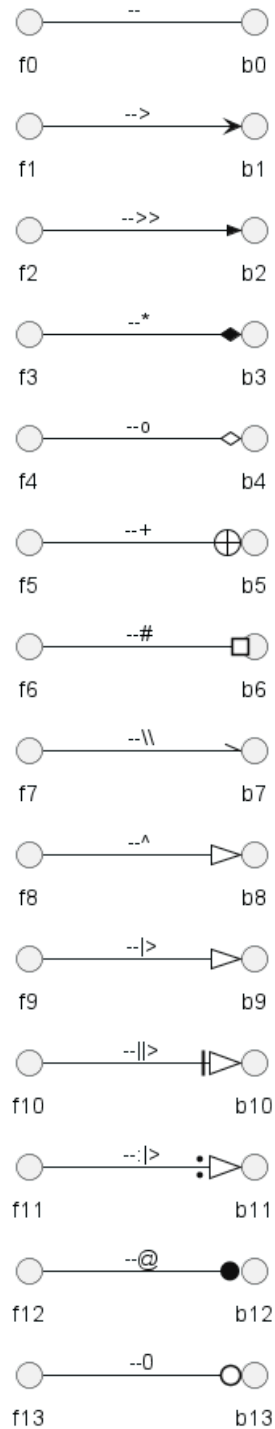

### 8.13.2 Type of '0' arrow or circle arrow

```

@startuml
left to right direction
skinparam nodesep 5

f10 0--0 b10 : "" 0--0 ""
f9 )--( b9 : "" )--( ""
f8 0)--(0 b8 : "" 0)--(0""
f7 0)-- b7 : "" 0)-- ""
f6 -0)- b6 : "" -0)- ""
f5 -(0)- b5 : "" -(0)-""

```



```
f4 -(0- b4 : "" -(0- ""
f3 --(0 b3 : "" --(0 ""
f2 --( b2 : "" --( ""
f1 --0 b1 : "" --0 ""
@enduml
```

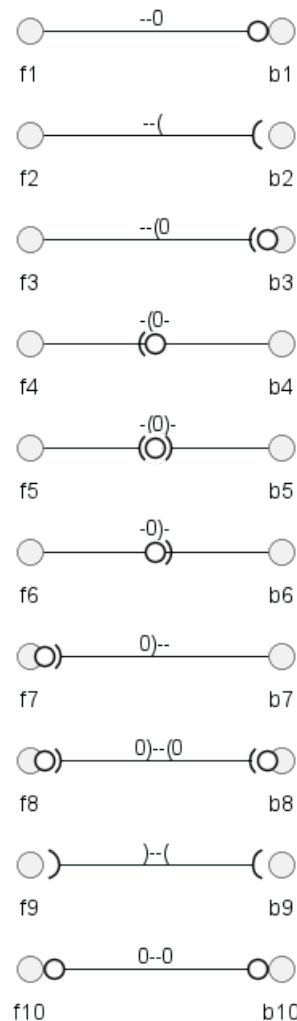

## 8.14 Appendix: Test of inline style on all element

### 8.14.1 Simple element

```
@startuml
actor actor #aliceblue;line:blue;line.dotted;text:blue
actor/ "actor/" #aliceblue;line:blue;line.dotted;text:blue
agent agent #aliceblue;line:blue;line.dotted;text:blue
artifact artifact #aliceblue;line:blue;line.dotted;text:blue
boundary boundary #aliceblue;line:blue;line.dotted;text:blue
card card #aliceblue;line:blue;line.dotted;text:blue
circle circle #aliceblue;line:blue;line.dotted;text:blue
cloud cloud #aliceblue;line:blue;line.dotted;text:blue
collections collections #aliceblue;line:blue;line.dotted;text:blue
component component #aliceblue;line:blue;line.dotted;text:blue
control control #aliceblue;line:blue;line.dotted;text:blue
database database #aliceblue;line:blue;line.dotted;text:blue
entity entity #aliceblue;line:blue;line.dotted;text:blue
file file #aliceblue;line:blue;line.dotted;text:blue
folder folder #aliceblue;line:blue;line.dotted;text:blue
```

```

frame frame #aliceblue;line:blue;line.dotted;text:blue
hexagon hexagon #aliceblue;line:blue;line.dotted;text:blue
interface interface #aliceblue;line:blue;line.dotted;text:blue
label label #aliceblue;line:blue;line.dotted;text:blue
node node #aliceblue;line:blue;line.dotted;text:blue
package package #aliceblue;line:blue;line.dotted;text:blue
person person #aliceblue;line:blue;line.dotted;text:blue
queue queue #aliceblue;line:blue;line.dotted;text:blue
rectangle rectangle #aliceblue;line:blue;line.dotted;text:blue
stack stack #aliceblue;line:blue;line.dotted;text:blue
storage storage #aliceblue;line:blue;line.dotted;text:blue
usecase usecase #aliceblue;line:blue;line.dotted;text:blue
usecase/ "usecase/" #aliceblue;line:blue;line.dotted;text:blue
@enduml

```

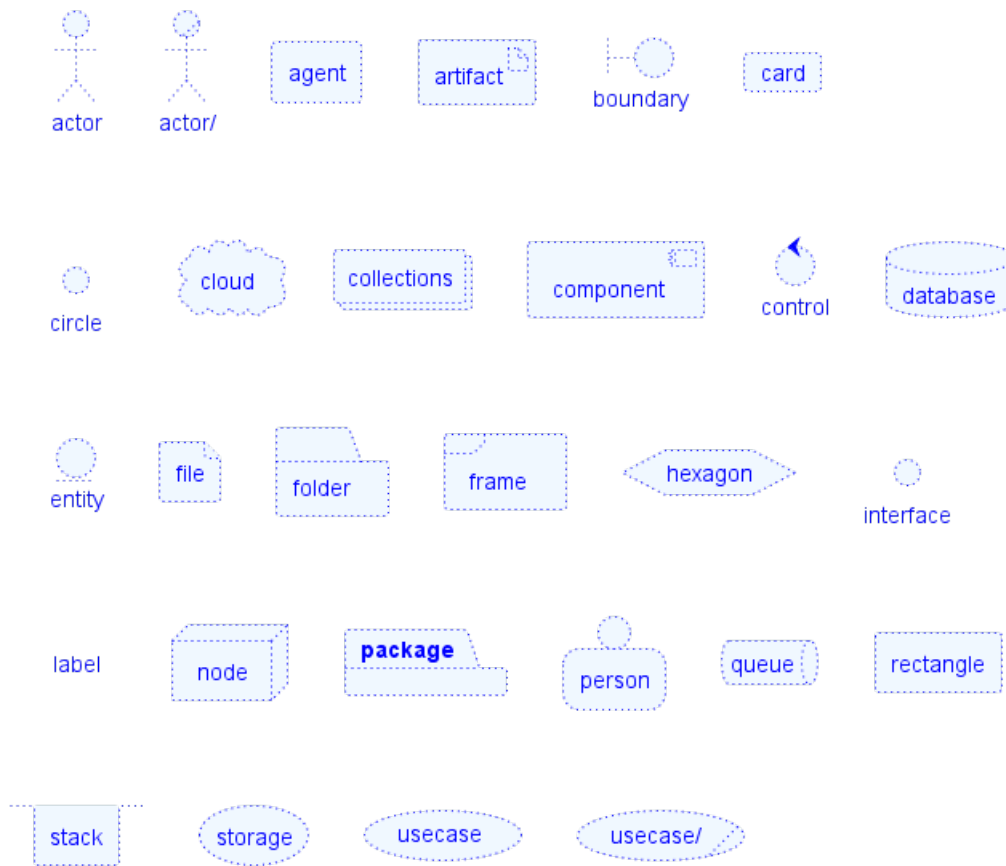

### 8.14.2 Nested element

### 8.14.3 Without sub-element

```

@startuml
artifact artifact #aliceblue;line:blue;line.dotted;text:blue {
}
card card #aliceblue;line:blue;line.dotted;text:blue {
}
cloud cloud #aliceblue;line:blue;line.dotted;text:blue {
}
component component #aliceblue;line:blue;line.dotted;text:blue {
}
database database #aliceblue;line:blue;line.dotted;text:blue {
}
file file #aliceblue;line:blue;line.dotted;text:blue {
}

```



```

}
folder folder #aliceblue;line:blue;line.dotted;text:blue {
}
frame frame #aliceblue;line:blue;line.dotted;text:blue {
}
hexagon hexagon #aliceblue;line:blue;line.dotted;text:blue {
}
node node #aliceblue;line:blue;line.dotted;text:blue {
}
package package #aliceblue;line:blue;line.dotted;text:blue {
}
queue queue #aliceblue;line:blue;line.dotted;text:blue {
}
rectangle rectangle #aliceblue;line:blue;line.dotted;text:blue {
}
stack stack #aliceblue;line:blue;line.dotted;text:blue {
}
storage storage #aliceblue;line:blue;line.dotted;text:blue {
}
@enduml

```



#### 8.14.4 With sub-element

```

@startuml
artifact      artifactVeryL00000000000000000000g      as "artifact" #aliceblue;line:blue;line.dotted;text:
file f1
}
card         cardVeryL00000000000000000000g         as "card" #aliceblue;line:blue;line.dotted;text:blu
file f2
}
cloud       cloudVeryL00000000000000000000g        as "cloud" #aliceblue;line:blue;line.dotted;text:bl
file f3
}
component   componentVeryL00000000000000000000g    as "component" #aliceblue;line:blue;line.dotted;text:
file f4
}
database    databaseVeryL00000000000000000000g     as "database" #aliceblue;line:blue;line.dotted;text:
file f5
}
file       fileVeryL00000000000000000000g          as "file" #aliceblue;line:blue;line.dotted;text:blu
file f6
}
folder     folderVeryL00000000000000000000g        as "folder" #aliceblue;line:blue;line.dotted;text:b
file f7
}
frame      frameVeryL00000000000000000000g         as "frame" #aliceblue;line:blue;line.dotted;text:bl
file f8
}
hexagon    hexagonVeryL00000000000000000000g       as "hexagon" #aliceblue;line:blue;line.dotted;text:
file f9
}
node       nodeVeryL00000000000000000000g          as "node" #aliceblue;line:blue;line.dotted;text:blu
file f10
}
package    packageVeryL00000000000000000000g       as "package" #aliceblue;line:blue;line.dotted;text:

```





```

file f11
}
queue      queueVeryL0000000000000000000g      as "queue" #aliceblue;line:blue;line.dotted;text:bl
file f12
}
rectangle  rectangleVeryL0000000000000000000g  as "rectangle" #aliceblue;line:blue;line.dotted;text:
file f13
}
stack      stackVeryL00000000000000000000g    as "stack" #aliceblue;line:blue;line.dotted;text:bl
file f14
}
storage    storageVeryL0000000000000000000g   as "storage" #aliceblue;line:blue;line.dotted;text:
file f15
}
@enduml

```

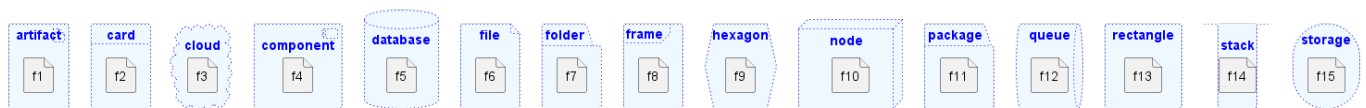

## 8.15 Appendix: Test of style on all element

### 8.15.1 Simple element

### 8.15.2 Global style (on componentDiagram)

```

@startuml
<style>
componentDiagram {
  BackGroundColor palegreen
  LineThickness 1
  LineColor red
}
document {
  BackGroundColor white
}
</style>
actor actor
actor/ "actor/"
agent agent
artifact artifact
boundary boundary
card card
circle circle
cloud cloud
collections collections
component component
control control
database database
entity entity
file file
folder folder
frame frame
hexagon hexagon
interface interface
label label
node node
package package

```



```

person person
queue queue
rectangle rectangle
stack stack
storage storage
usecase usecase
usecase/ "usecase/"
@enduml

```

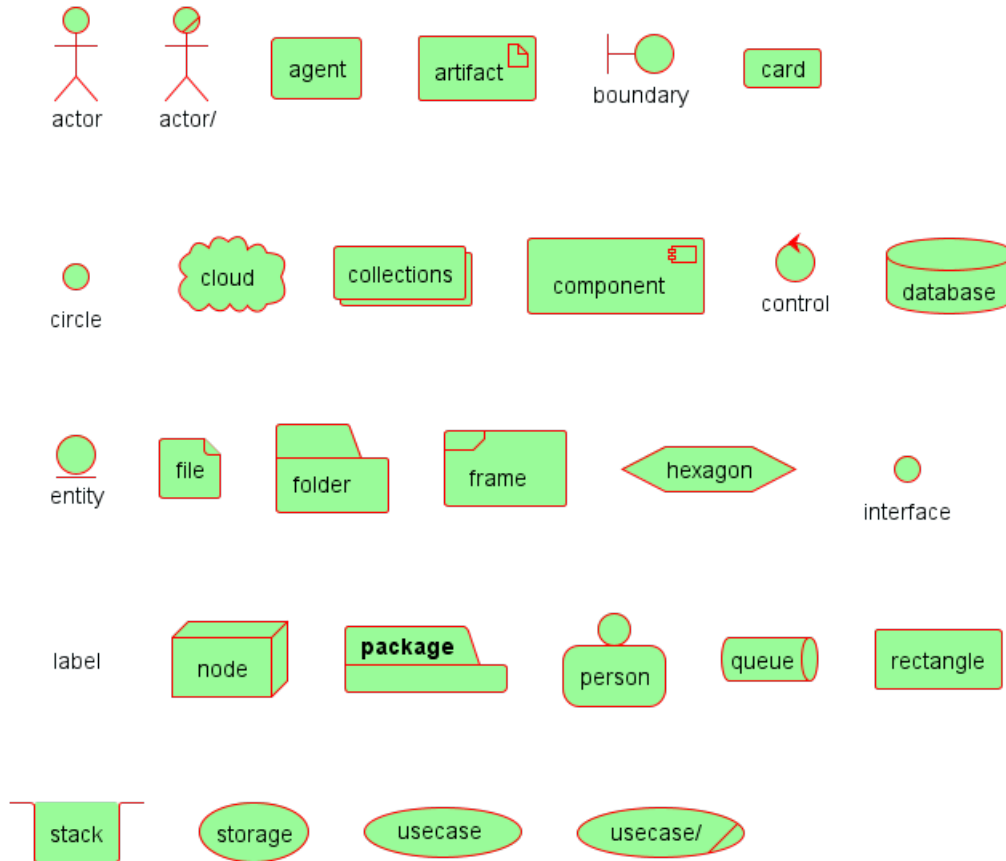

### 8.15.3 Style for each element

```

@startuml
<style>
actor {
  BackGroundColor #f80c12
  LineThickness 1
  LineColor black
}
agent {
  BackGroundColor #f80c12
  LineThickness 1
  LineColor black
}
artifact {
  BackGroundColor #ee1100
  LineThickness 1
  LineColor black
}
boundary {
  BackGroundColor #ee1100
  LineThickness 1
}

```



```
    LineColor black
}
card {
    BackGroundColor #ff3311
    LineThickness 1
    LineColor black
}
circle {
    BackGroundColor #ff3311
    LineThickness 1
    LineColor black
}
cloud {
    BackGroundColor #ff4422
    LineThickness 1
    LineColor black
}
collections {
    BackGroundColor #ff4422
    LineThickness 1
    LineColor black
}
component {
    BackGroundColor #ff6644
    LineThickness 1
    LineColor black
}
control {
    BackGroundColor #ff6644
    LineThickness 1
    LineColor black
}
database {
    BackGroundColor #ff9933
    LineThickness 1
    LineColor black
}
entity {
    BackGroundColor #feae2d
    LineThickness 1
    LineColor black
}
file {
    BackGroundColor #feae2d
    LineThickness 1
    LineColor black
}
folder {
    BackGroundColor #ccbb33
    LineThickness 1
    LineColor black
}
frame {
    BackGroundColor #d0c310
    LineThickness 1
    LineColor black
}
hexagon {
```



```
    BackGroundColor #aacc22
    LineThickness 1
    LineColor black
}
interface {
    BackGroundColor #69d025
    LineThickness 1
    LineColor black
}
label {
    BackGroundColor black
    LineThickness 1
    LineColor black
}
node {
    BackGroundColor #22ccaa
    LineThickness 1
    LineColor black
}
package {
    BackGroundColor #12bdb9
    LineThickness 1
    LineColor black
}
person {
    BackGroundColor #11aabb
    LineThickness 1
    LineColor black
}
queue {
    BackGroundColor #11aabb
    LineThickness 1
    LineColor black
}
rectangle {
    BackGroundColor #4444dd
    LineThickness 1
    LineColor black
}
stack {
    BackGroundColor #3311bb
    LineThickness 1
    LineColor black
}
storage {
    BackGroundColor #3b0cbd
    LineThickness 1
    LineColor black
}
usecase {
    BackGroundColor #442299
    LineThickness 1
    LineColor black
}
</style>
actor actor
actor/ "actor/"
agent agent
```



```

artifact artifact
boundary boundary
card card
circle circle
cloud cloud
collections collections
component component
control control
database database
entity entity
file file
folder folder
frame frame
hexagon hexagon
interface interface
label label
node node
package package
person person
queue queue
rectangle rectangle
stack stack
storage storage
usecase usecase
usecase/ "usecase/"
@enduml

```

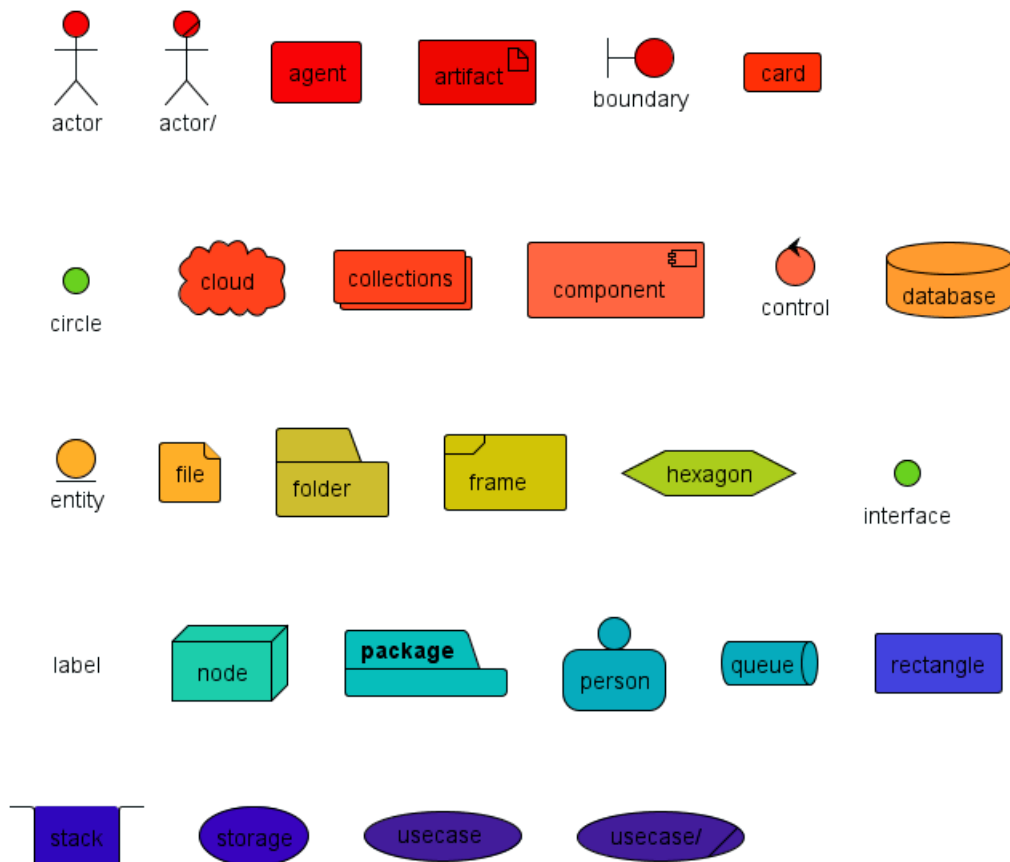

[Ref. QA-13261]

**8.15.4 Nested element (without level)****8.15.5 Global style (on componentDiagram)**

```

@startuml
<style>
componentDiagram {
  BackGroundColor palegreen
  LineThickness 2
  LineColor red
}
</style>
artifact artifact {
}
card card {
}
cloud cloud {
}
component component {
}
database database {
}
file file {
}
folder folder {
}
frame frame {
}
hexagon hexagon {
}
node node {
}
package package {
}
queue queue {
}
rectangle rectangle {
}
stack stack {
}
storage storage {
}
@enduml

```

**8.15.6 Style for each nested element**

```

@startuml
<style>
artifact {
  BackGroundColor #ee1100
  LineThickness 1
  LineColor black
}
card {
  BackGroundColor #ff3311
  LineThickness 1
}

```



```
    LineColor black
}
cloud {
    BackGroundColor #ff4422
    LineThickness 1
    LineColor black
}
component {
    BackGroundColor #ff6644
    LineThickness 1
    LineColor black
}
database {
    BackGroundColor #ff9933
    LineThickness 1
    LineColor black
}
file {
    BackGroundColor #feae2d
    LineThickness 1
    LineColor black
}
folder {
    BackGroundColor #ccbb33
    LineThickness 1
    LineColor black
}
frame {
    BackGroundColor #d0c310
    LineThickness 1
    LineColor black
}
hexagon {
    BackGroundColor #aacc22
    LineThickness 1
    LineColor black
}
node {
    BackGroundColor #22ccaa
    LineThickness 1
    LineColor black
}
package {
    BackGroundColor #12bdb9
    LineThickness 1
    LineColor black
}
queue {
    BackGroundColor #11aabb
    LineThickness 1
    LineColor black
}
rectangle {
    BackGroundColor #4444dd
    LineThickness 1
    LineColor black
}
stack {
```



```

    BackGroundColor #3311bb
    LineThickness 1
    LineColor black
}
storage {
    BackGroundColor #3b0cbd
    LineThickness 1
    LineColor black
}

</style>
artifact artifact {
}
card card {
}
cloud cloud {
}
component component {
}
database database {
}
file file {
}
folder folder {
}
frame frame {
}
hexagon hexagon {
}
node node {
}
package package {
}
queue queue {
}
rectangle rectangle {
}
stack stack {
}
storage storage {
}
@enduml

```

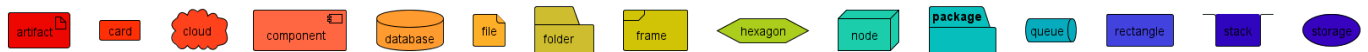

### 8.15.7 Nested element (with one level)

### 8.15.8 Global style (on componentDiagram)

```

@startuml
<style>
componentDiagram {
    BackGroundColor palegreen
    LineThickness 1
    LineColor red
}
document {
    BackGroundColor white

```



```

}
</style>
artifact e1 as "artifact" {
file f1
}
card e2 as "card" {
file f2
}
cloud e3 as "cloud" {
file f3
}
component e4 as "component" {
file f4
}
database e5 as "database" {
file f5
}
file e6 as "file" {
file f6
}
folder e7 as "folder" {
file f7
}
frame e8 as "frame" {
file f8
}
hexagon e9 as "hexagon" {
file f9
}
node e10 as "node" {
file f10
}
package e11 as "package" {
file f11
}
queue e12 as "queue" {
file f12
}
rectangle e13 as "rectangle" {
file f13
}
stack e14 as "stack" {
file f14
}
storage e15 as "storage" {
file f15
}
@enduml

```

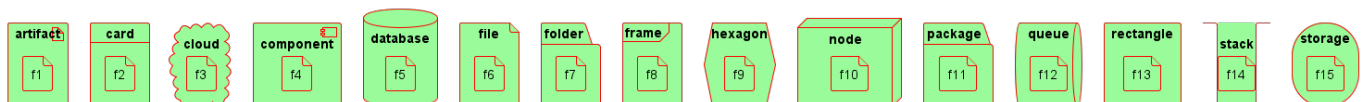

### 8.15.9 Style for each nested element

```

@startuml
<style>

```

```
artifact {
  BackGroundColor #ee1100
  LineThickness 1
  LineColor black
}
card {
  BackGroundColor #ff3311
  LineThickness 1
  LineColor black
}
cloud {
  BackGroundColor #ff4422
  LineThickness 1
  LineColor black
}
component {
  BackGroundColor #ff6644
  LineThickness 1
  LineColor black
}
database {
  BackGroundColor #ff9933
  LineThickness 1
  LineColor black
}
file {
  BackGroundColor #feae2d
  LineThickness 1
  LineColor black
}
folder {
  BackGroundColor #ccb333
  LineThickness 1
  LineColor black
}
frame {
  BackGroundColor #d0c310
  LineThickness 1
  LineColor black
}
hexagon {
  BackGroundColor #aacc22
  LineThickness 1
  LineColor black
}
node {
  BackGroundColor #22ccaa
  LineThickness 1
  LineColor black
}
package {
  BackGroundColor #12bdb9
  LineThickness 1
  LineColor black
}
queue {
  BackGroundColor #11aabb
  LineThickness 1
}
```



```
    LineColor black
  }
  rectangle {
    BackGroundColor #4444dd
    LineThickness 1
    LineColor black
  }
  stack {
    BackGroundColor #3311bb
    LineThickness 1
    LineColor black
  }
  storage {
    BackGroundColor #3b0cbd
    LineThickness 1
    LineColor black
  }
</style>
artifact e1 as "artifact" {
  file f1
}
card e2 as "card" {
  file f2
}
cloud e3 as "cloud" {
  file f3
}
component e4 as "component" {
  file f4
}
database e5 as "database" {
  file f5
}
file e6 as "file" {
  file f6
}
folder e7 as "folder" {
  file f7
}
frame e8 as "frame" {
  file f8
}
hexagon e9 as "hexagon" {
  file f9
}
node e10 as "node" {
  file f10
}
package e11 as "package" {
  file f11
}
queue e12 as "queue" {
  file f12
}
rectangle e13 as "rectangle" {
  file f13
}
stack e14 as "stack" {
```



```

file f14
}
storage e15 as "storage" {
file f15
}
@enduml

```

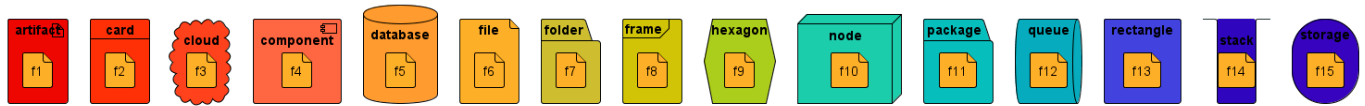

## 8.16 Appendix: Test of stereotype with style on all element

### 8.16.1 Simple element

```

@startuml
<style>
.stereo {
  BackgroundColor palegreen
}
</style>
actor actor << stereo >>
actor/ "actor/" << stereo >>
agent agent << stereo >>
artifact artifact << stereo >>
boundary boundary << stereo >>
card card << stereo >>
circle circle << stereo >>
cloud cloud << stereo >>
collections collections << stereo >>
component component << stereo >>
control control << stereo >>
database database << stereo >>
entity entity << stereo >>
file file << stereo >>
folder folder << stereo >>
frame frame << stereo >>
hexagon hexagon << stereo >>
interface interface << stereo >>
label label << stereo >>
node node << stereo >>
package package << stereo >>
person person << stereo >>
queue queue << stereo >>
rectangle rectangle << stereo >>
stack stack << stereo >>
storage storage << stereo >>
usecase usecase << stereo >>
usecase/ "usecase/" << stereo >>
@enduml

```

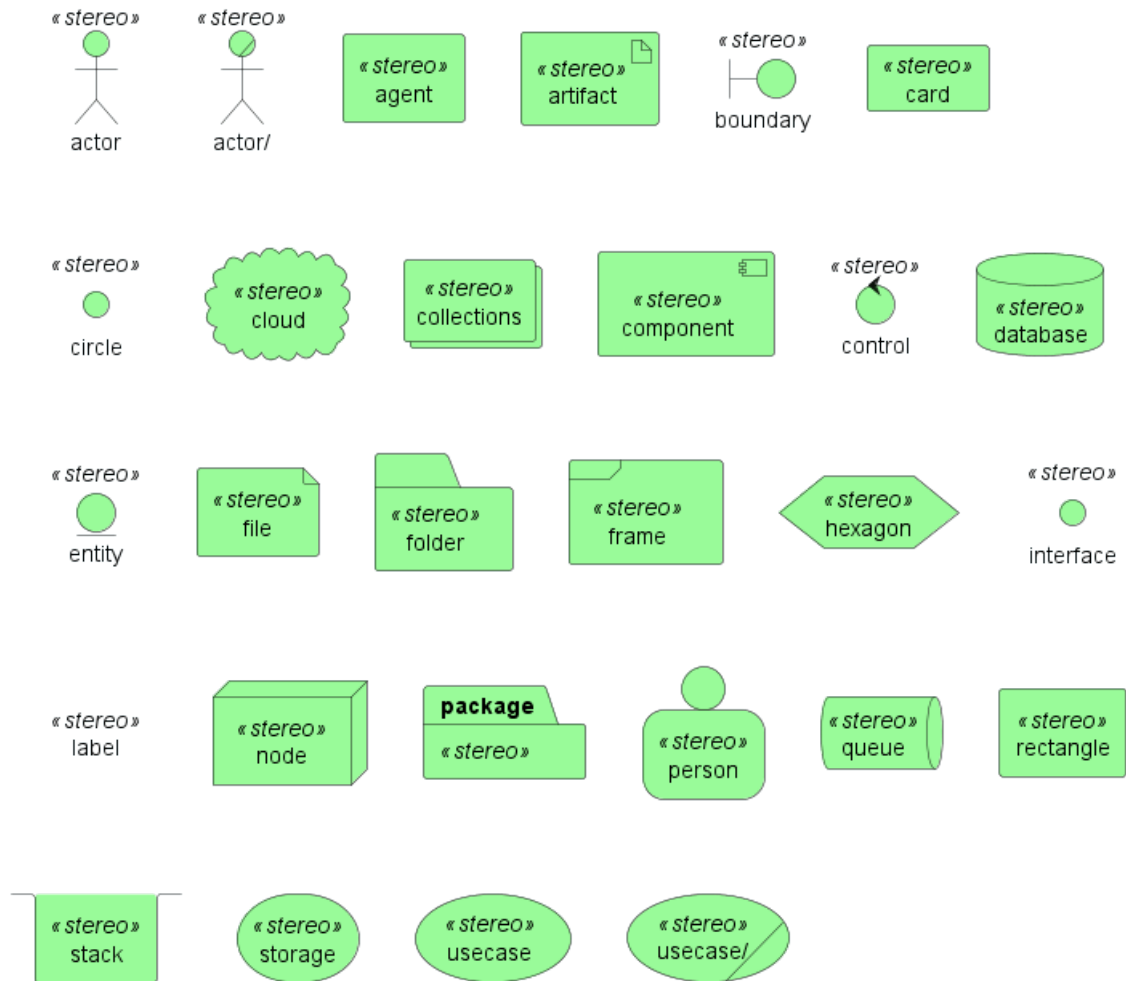

## 8.17 Display JSON Data on Deployment diagram

### 8.17.1 Simple example

```

@startuml
allowmixing

component Component
actor Actor
usecase Usecase
() Interface
node Node
cloud Cloud

json JSON {
    "fruit": "Apple",
    "size": "Large",
    "color": ["Red", "Green"]
}
@enduml

```

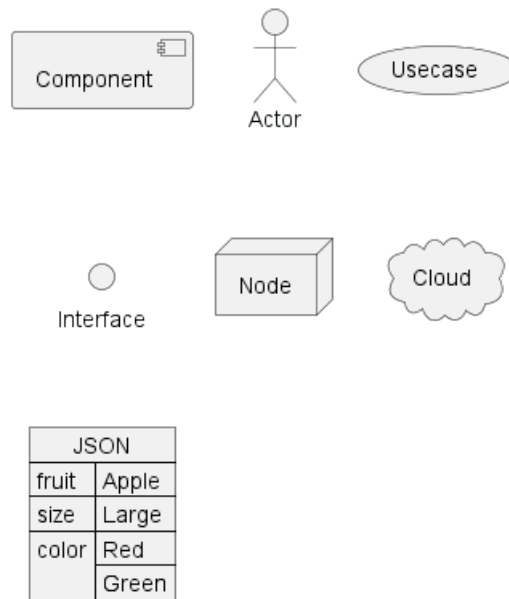

[Ref. QA-15481]

For another example, see on JSON page.

## 8.18 Mixing Deployment (Usecase, Component, Deployment) element within a Class or Object diagram

In order to add a Deployment element or a State element within a Class or Object diagram, you can use the `allowmixing` or `allow_mixing` directive.

### 8.18.1 Mixing all elements

```
@startuml
allowmixing

skinparam nodesep 10
abstract      abstract
abstract class "abstract class"
annotation    annotation
circle        circle
()            circle_short_form
class         class
diamond       diamond
<>           diamond_short_form
entity        entity
enum          enum
exception     exception
interface     interface
metaclass     metaclass
protocol      protocol
stereotype    stereotype
struct        struct
object        object
map map {
  key => value
}
json JSON {
  "fruit": "Apple",
```



```
    "size": "Large",
    "color": ["Red", "Green"]
}
actor actor
actor/ "actor/"
agent agent
artifact artifact
boundary boundary
card card
circle circle
cloud cloud
collections collections
component component
control control
database database
entity entity
file file
folder folder
frame frame
hexagon hexagon
interface interface
label label
node node
package package
person person
queue queue
rectangle rectangle
stack stack
storage storage
usecase usecase
usecase/ "usecase/"
state state
@enduml
```

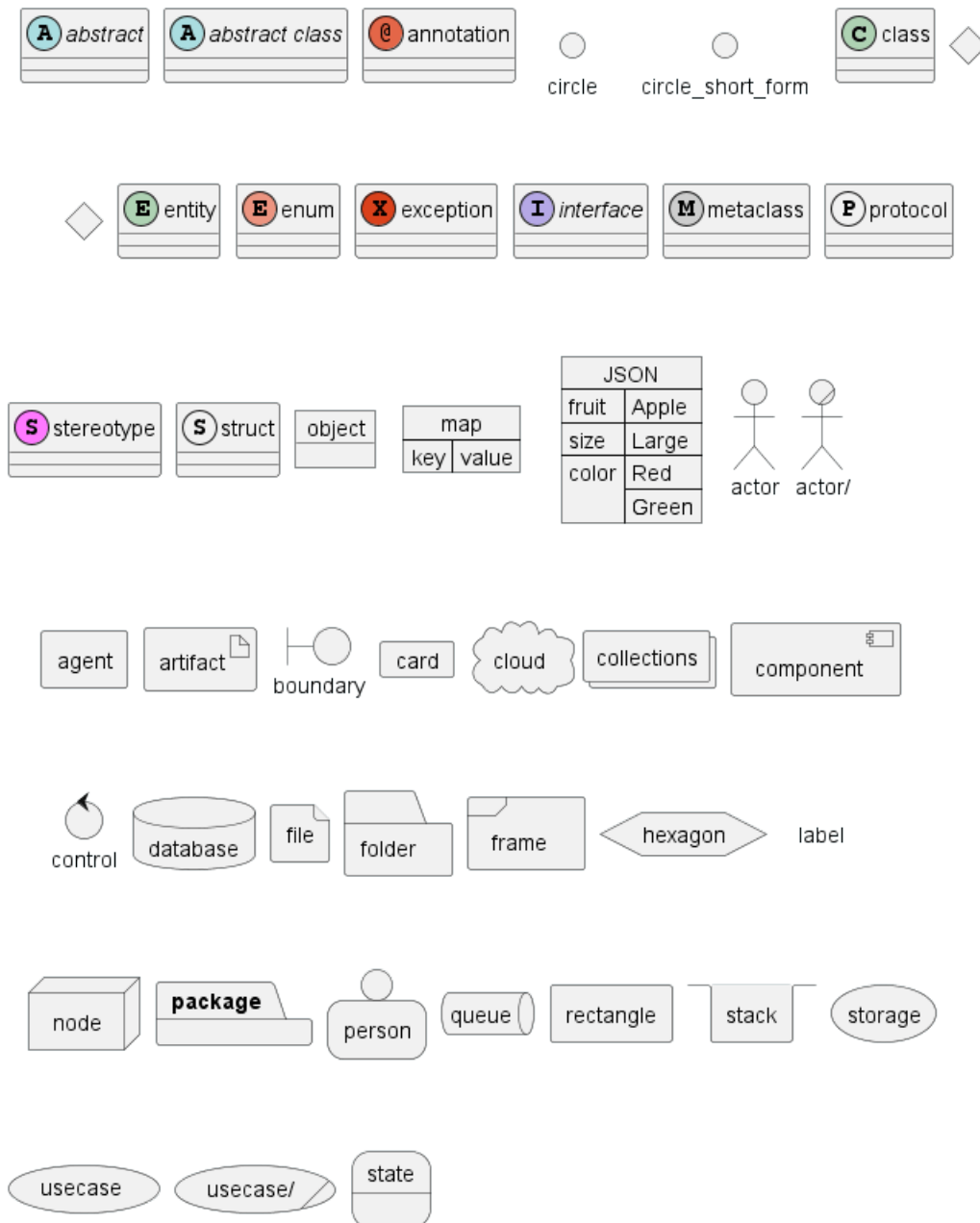

[Ref. QA-2335 and QA-5329]

## 8.19 Port [port, portIn, portOut]

You can added **port** with port, portin and portout keywords.

### 8.19.1 Port

```
@startuml
[c]
node node {
  port p1
  port p2
  port p3
  file f1
}

c --> p1
```





```

c --> p2
c --> p3
p1 --> f1
p2 --> f1
@enduml

```

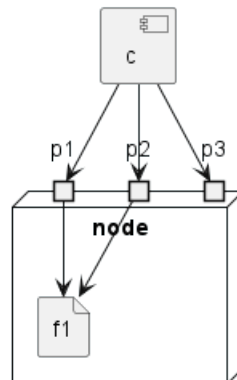

### 8.19.2 PortIn

```

@startuml
[c]
node node {
    portin p1
    portin p2
    portin p3
    file f1
}
c --> p1
c --> p2
c --> p3
p1 --> f1
p2 --> f1
@enduml

```

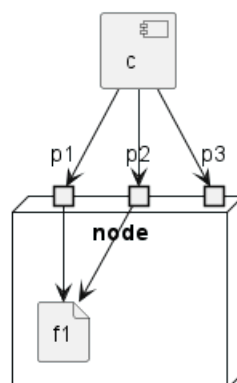

### 8.19.3 PortOut

```

@startuml
node node {
    portout p1
    portout p2
    portout p3
    file f1
}

```



```

}
[o]
p1 --> o
p2 --> o
p3 --> o
f1 --> p1
@enduml

```

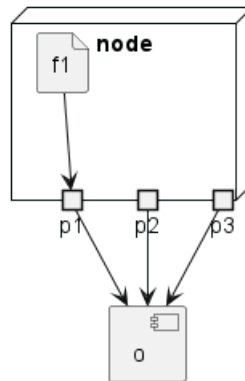

#### 8.19.4 Mixing PortIn & PortOut

```

@startuml
[i]
node node {
  portin p1
  portin p2
  portin p3
  portout po1
  portout po2
  portout po3
  file f1
}
[o]

i --> p1
i --> p2
i --> p3
p1 --> f1
p2 --> f1
po1 --> o
po2 --> o
po3 --> o
f1 --> po1
@enduml

```

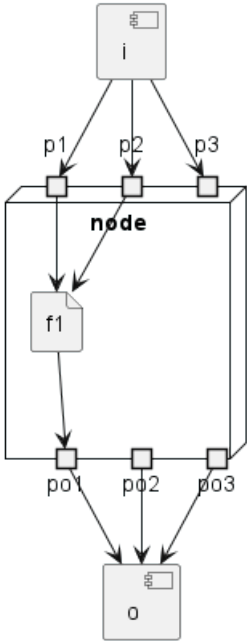

## 9 State Diagram

**State diagrams** provide a visual representation of the various states a system or an object can be in, as well as the transitions between those states. They are essential in modeling the dynamic behavior of systems, capturing how they respond to different events over time. State diagrams depict the system's life cycle, making it easier to understand, design, and optimize its behavior.

Using **PlantUML** to create state diagrams offers several advantages:

- **Text-Based Language:** Quickly define and visualize the states and transitions without the hassle of manual drawing.
- **Efficiency and Consistency:** Ensure streamlined diagram creation and easy version control.
- **Versatility:** Integrate with various documentation platforms and support multiple output formats.
- **Open-Source & Community Support:** Backed by a **strong community** that continuously contributes to its enhancements and offers invaluable resources.

### 9.1 Simple State

You can use `[*]` for the starting point and ending point of the state diagram.

Use `-->` for arrows.

```
@startuml
[*] --> State1
State1 --> [*]
State1 : this is a string
State1 : this is another string

State1 -> State2
State2 --> [*]

@enduml
```

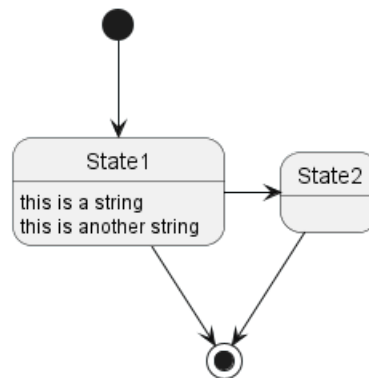

### 9.2 Change state rendering

You can use `hide empty description` to render state as simple box.

```
@startuml
hide empty description
[*] --> State1
State1 --> [*]
State1 : this is a string
State1 : this is another string

State1 -> State2
State2 --> [*]

@enduml
```



```
@enduml
```

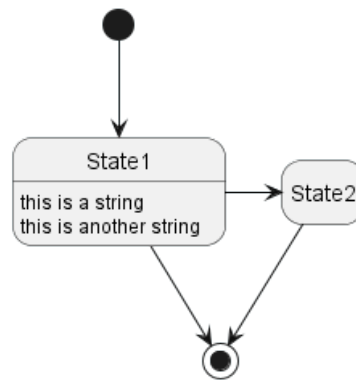

### 9.3 Composite state

A state can also be composite. You have to define it using the `state` keywords and brackets.

#### 9.3.1 Internal sub-state

```

@startuml
scale 350 width
[*] --> NotShooting

state NotShooting {
  [*] --> Idle
  Idle --> Configuring : EvConfig
  Configuring --> Idle : EvConfig
}

state Configuring {
  [*] --> NewValueSelection
  NewValueSelection --> NewValuePreview : EvNewValue
  NewValuePreview --> NewValueSelection : EvNewValueRejected
  NewValuePreview --> NewValueSelection : EvNewValueSaved

  state NewValuePreview {
    State1 -> State2
  }
}

@enduml

```

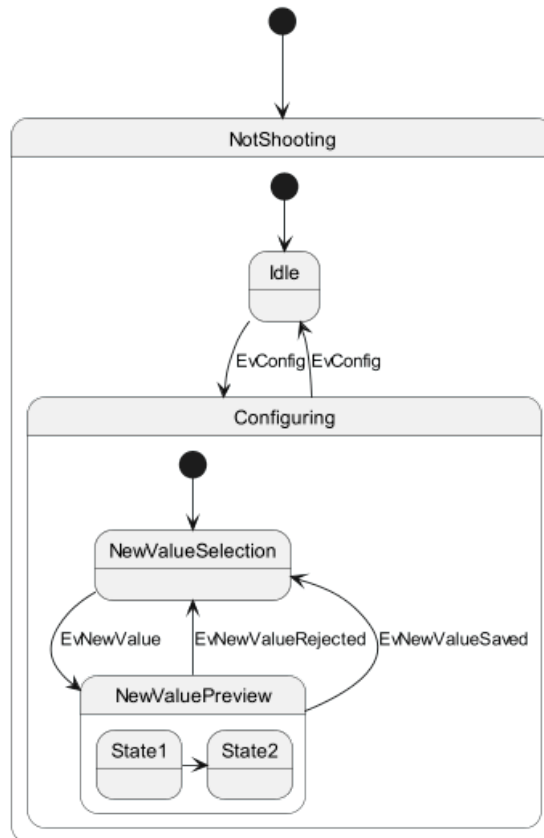

9.3.2 Sub-state to sub-state

```

@startuml
state A {
  state X {
  }
  state Y {
  }
}

state B {
  state Z {
  }
}

X --> Z
Z --> Y
@enduml

```

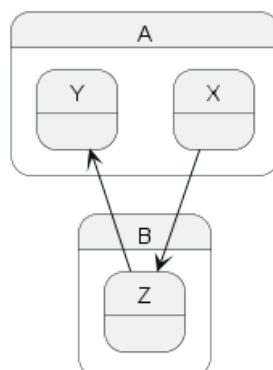

[Ref. QA-3300]

## 9.4 Long name

You can also use the `state` keyword to use long description for states.

```
@startuml
scale 600 width

[*] -> State1
State1 --> State2 : Succeeded
State1 --> [*] : Aborted
State2 --> State3 : Succeeded
State2 --> [*] : Aborted
state State3 {
  state "Accumulate Enough Data\nLong State Name" as long1
  long1 : Just a test
  [*] --> long1
  long1 --> long1 : New Data
  long1 --> ProcessData : Enough Data
}
State3 --> State3 : Failed
State3 --> [*] : Succeeded / Save Result
State3 --> [*] : Aborted

@enduml
```

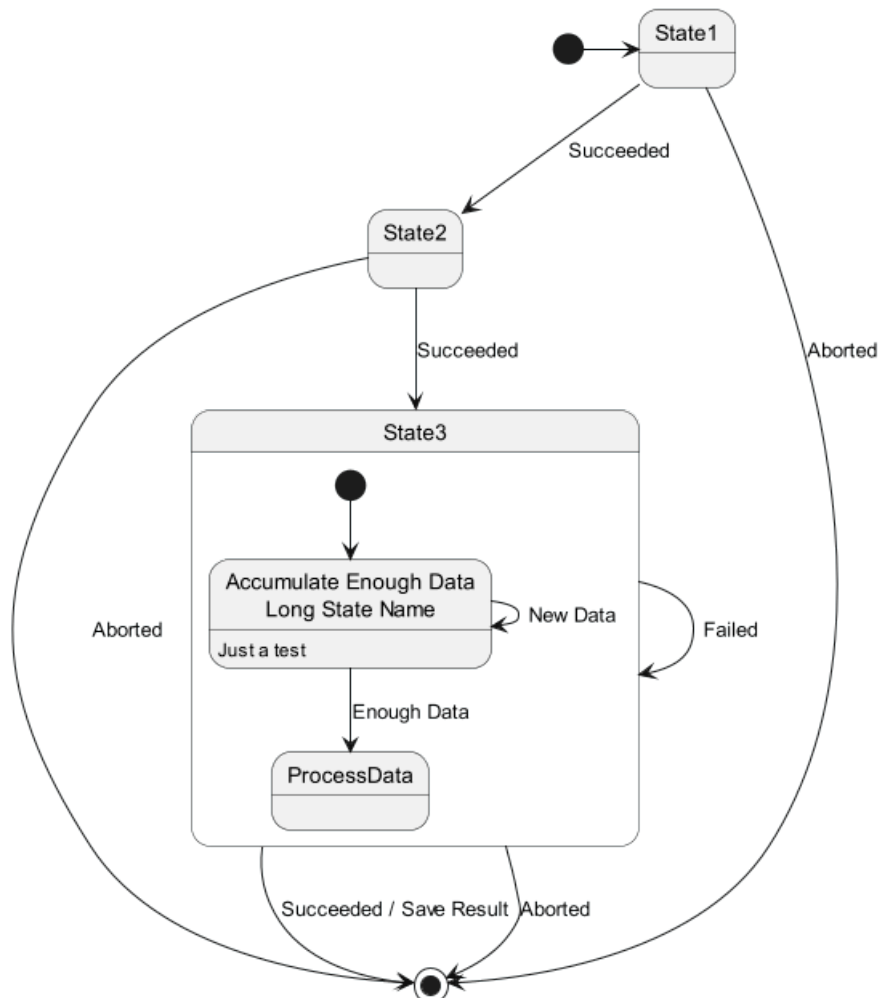

## 9.5 History $[[H], [H^*]]$

You can use  $[H]$  for the history and  $[H^*]$  for the deep history of a substate.

```

@startuml
[*] -> State1
State1 --> State2 : Succeeded
State1 --> [*] : Aborted
State2 --> State3 : Succeeded
State2 --> [*] : Aborted
state State3 {
  state "Accumulate Enough Data" as long1
  long1 : Just a test
  [*] --> long1
  long1 --> long1 : New Data
  long1 --> ProcessData : Enough Data
  State2 --> [H]: Resume
}
State3 --> State2 : Pause
State2 --> State3[H*]: DeepResume
State3 --> State3 : Failed
State3 --> [*] : Succeeded / Save Result
State3 --> [*] : Aborted
@enduml

```

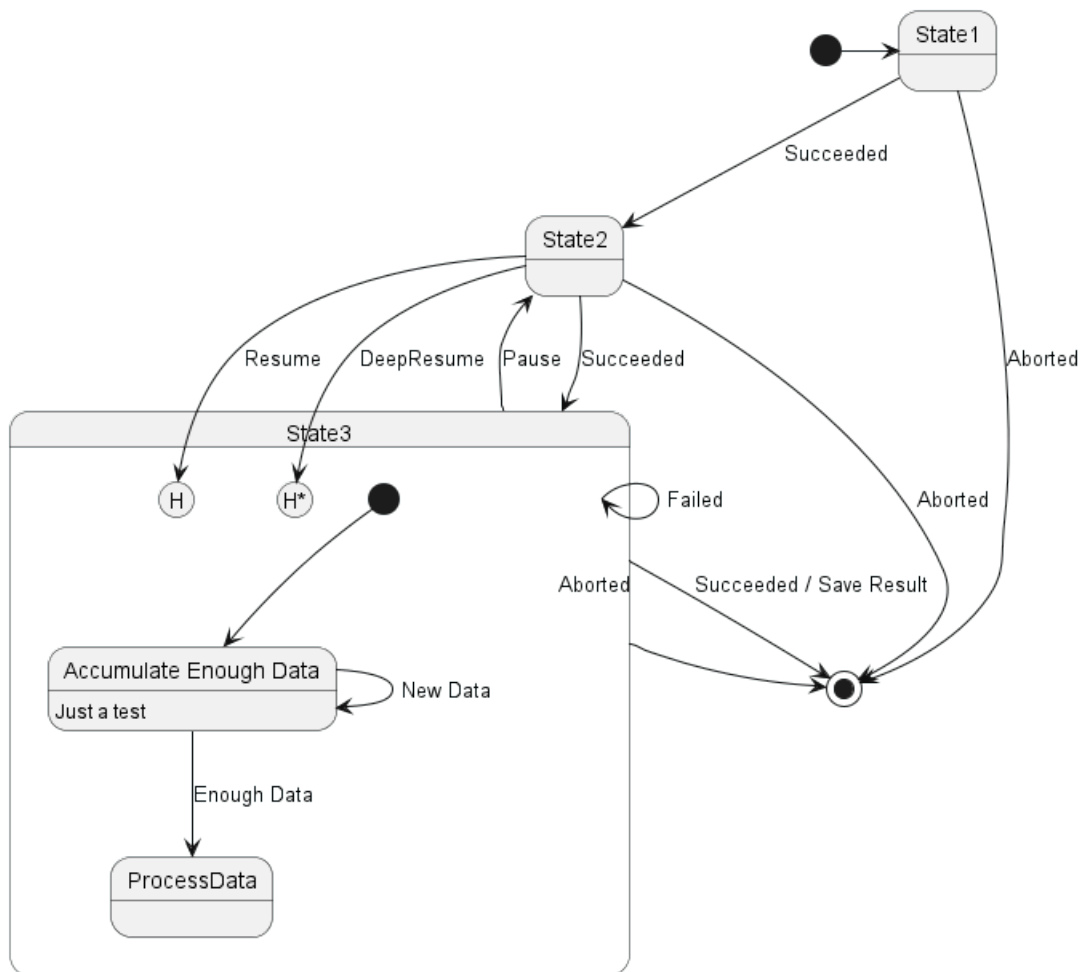

## 9.6 Fork $[fork, join]$

You can also fork and join using the `<<fork>>` and `<<join>>` stereotypes.



```

@startuml

state fork_state <<fork>>
[*] --> fork_state
fork_state --> State2
fork_state --> State3

state join_state <<join>>
State2 --> join_state
State3 --> join_state
join_state --> State4
State4 --> [*]

@enduml

```

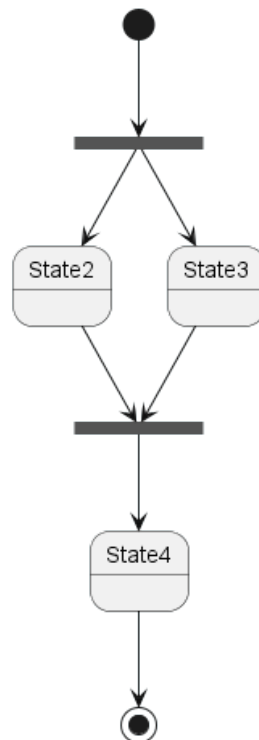

## 9.7 Concurrent state [-, ||]

You can define concurrent state into a composite state using either -- or || symbol as separator.

### 9.7.1 Horizontal separator --

```

@startuml
[*] --> Active

state Active {
    [*] -> NumLockOff
    NumLockOff --> NumLockOn : EvNumLockPressed
    NumLockOn --> NumLockOff : EvNumLockPressed
    --
    [*] -> CapsLockOff
    CapsLockOff --> CapsLockOn : EvCapsLockPressed
    CapsLockOn --> CapsLockOff : EvCapsLockPressed
    --
    [*] -> ScrollLockOff
    ScrollLockOff --> ScrollLockOn : EvScrollLockPressed
}

```



```

    ScrollLockOn --> ScrollLockOff : EvScrollLockPressed
}
@enduml

```

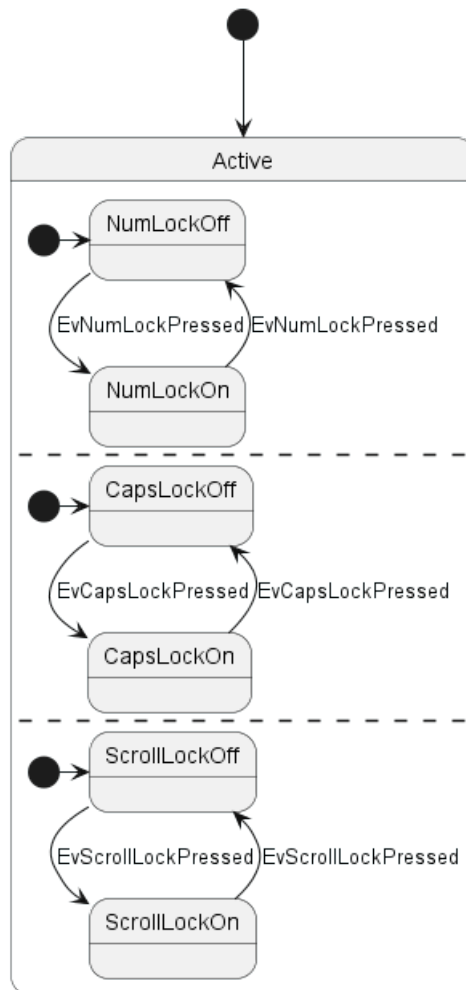

### 9.7.2 Vertical separator ||

```

@startuml
[*] --> Active

state Active {
    [*] -> NumLockOff
    NumLockOff --> NumLockOn : EvNumLockPressed
    NumLockOn --> NumLockOff : EvNumLockPressed
    ||
    [*] -> CapsLockOff
    CapsLockOff --> CapsLockOn : EvCapsLockPressed
    CapsLockOn --> CapsLockOff : EvCapsLockPressed
    ||
    [*] -> ScrollLockOff
    ScrollLockOff --> ScrollLockOn : EvScrollLockPressed
    ScrollLockOn --> ScrollLockOff : EvScrollLockPressed
}

@enduml

```

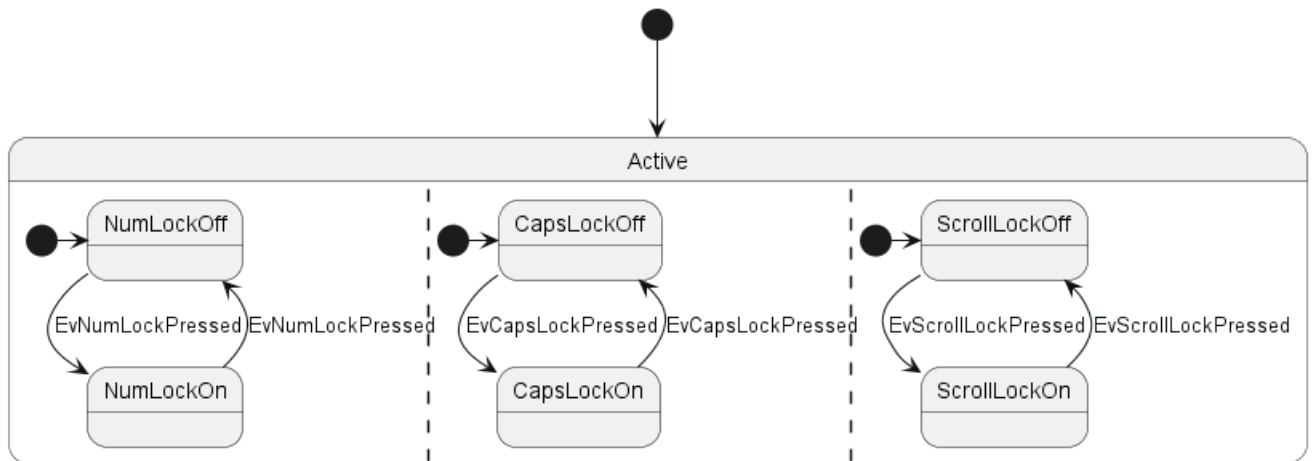

[Ref. QA-3086]

## 9.8 Conditional [choice]

The stereotype <<choice>> can be used to use conditional state.

```

@startuml
state "Req(Id)" as ReqId <<sdlreceive>>
state "Minor(Id)" as MinorId
state "Major(Id)" as MajorId

state c <<choice>>

Idle --> ReqId
ReqId --> c
c --> MinorId : [Id <= 10]
c --> MajorId : [Id > 10]
@enduml

```

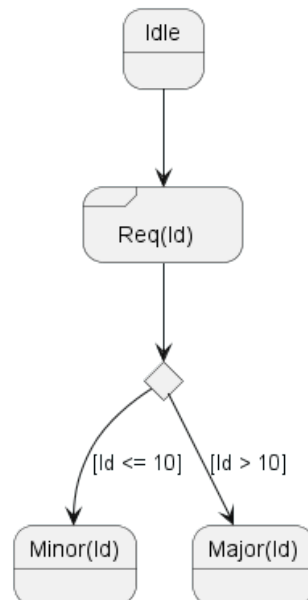

## 9.9 Stereotypes full example [start, choice, fork, join, end]

```

@startuml
state start1 <<start>>
state choice1 <<choice>>

```



```

state fork1    <<fork>>
state join2    <<join>>
state end3     <<end>>

[*]    --> choice1 : from start\nto choice
start1 --> choice1 : from start stereo\nto choice

choice1 --> fork1   : from choice\nto fork
choice1 --> join2   : from choice\nto join
choice1 --> end3    : from choice\nto end stereo

fork1   ---> State1 : from fork\nto state
fork1   --> State2 : from fork\nto state

State2  --> join2   : from state\nto join
State1  --> [*]    : from state\nto end

join2   --> [*]    : from join\nto end
@enduml

```

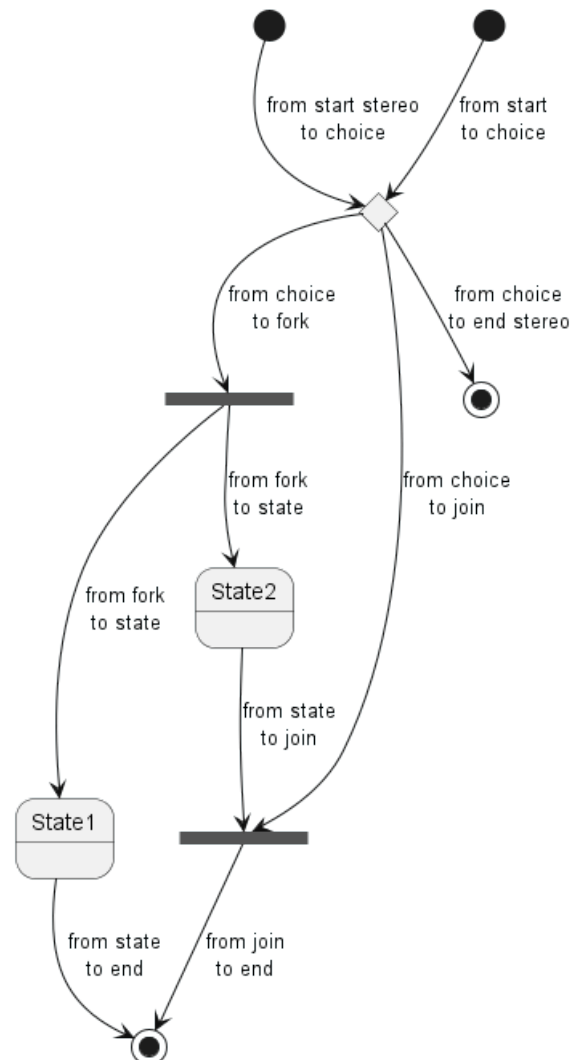

[Ref. QA-404, QA-1159 and GH-887]

## 9.10 Point [entryPoint, exitPoint]

You can add **point** with <<entryPoint>> and <<exitPoint>> stereotypes:



```

@startuml
state Somp {
  state entry1 <<entryPoint>>
  state entry2 <<entryPoint>>
  state sin
  entry1 --> sin
  entry2 -> sin
  sin -> sin2
  sin2 --> exitA <<exitPoint>>
}

[*] --> entry1
exitA --> Foo
Foo1 -> entry2
@enduml

```

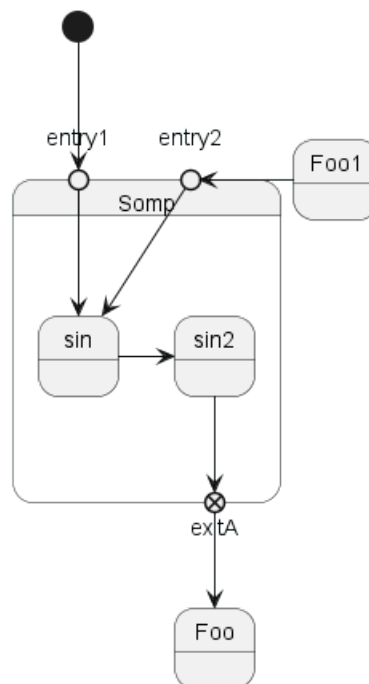

## 9.11 Pin [inputPin, outputPin]

You can add **pin** with `<<inputPin>>` and `<<outputPin>>` stereotypes:

```

@startuml
state Somp {
  state entry1 <<inputPin>>
  state entry2 <<inputPin>>
  state sin
  entry1 --> sin
  entry2 -> sin
  sin -> sin2
  sin2 --> exitA <<outputPin>>
}

[*] --> entry1
exitA --> Foo
Foo1 -> entry2
@enduml

```

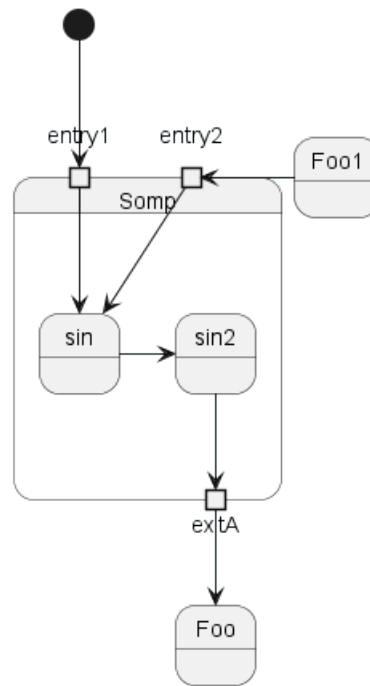

[Ref. QA-4309]

## 9.12 Expansion [expansionInput, expansionOutput]

You can add **expansion** with `<<expansionInput>>` and `<<expansionOutput>>` stereotypes:

```

@startuml
state Somp {
    state entry1 <<expansionInput>>
    state entry2 <<expansionInput>>
    state sin
    entry1 --> sin
    entry2 -> sin
    sin -> sin2
    sin2 --> exitA <<expansionOutput>>
}
  
```

```

[*] --> entry1
exitA --> Foo
Foo1 -> entry2
@enduml
  
```

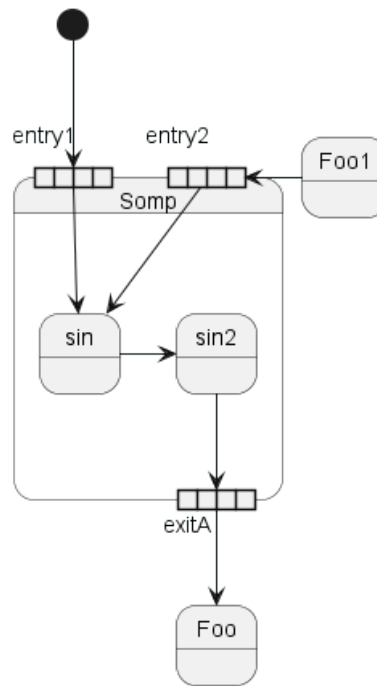

[Ref. QA-4309]

### 9.13 Arrow direction

You can use `->` for horizontal arrows. It is possible to force arrow's direction using the following syntax:

- `-down->` or `-->`
- `-right->` or `->` (*default arrow*)
- `-left->`
- `-up->`

```
@startuml
```

```
[*] -up-> First
First -right-> Second
Second --> Third
Third -left-> Last
```

```
@enduml
```

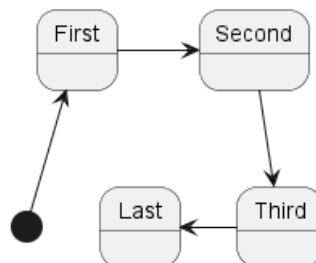

You can shorten the arrow definition by using only the first character of the direction (for example, `-d-` instead of `-down-`) or the two first characters (`-do-`).

Please note that you should not abuse this functionality : *Graphviz* gives usually good results without tweaking.



## 9.14 Change line color and style

You can change line color and/or line style.

```
@startuml
State S1
State S2
S1 -[#DD00AA]-> S2
S1 -left[#yellow]-> S3
S1 -up[#red,dashed]-> S4
S1 -right[dotted,#blue]-> S5

X1 -[dashed]-> X2
Z1 -[dotted]-> Z2
Y1 -[#blue,bold]-> Y2
@enduml
```

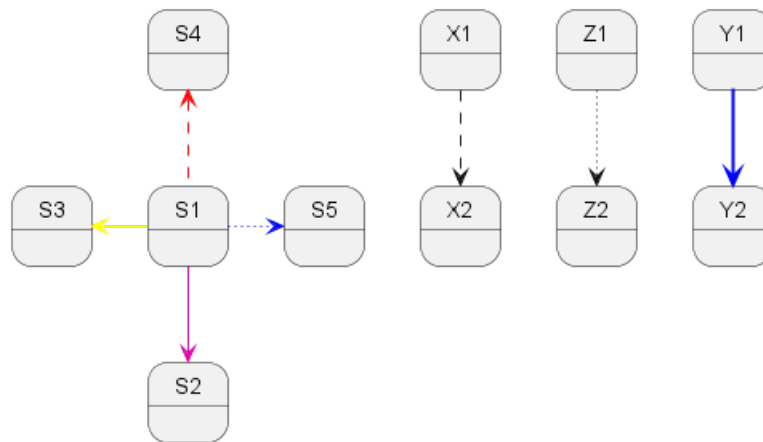

[Ref. Incubation: Change line color in state diagrams]

## 9.15 Note

You can also define notes using `note left of`, `note right of`, `note top of`, `note bottom of` of keywords.

You can also define notes on several lines.

```
@startuml

[*] --> Active
Active --> Inactive

note left of Active : this is a short\nnote

note right of Inactive
  A note can also
  be defined on
  several lines
end note

@enduml
```





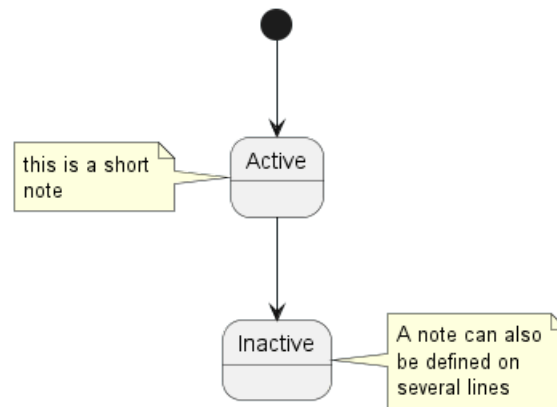

You can also have floating notes.

```

@startuml
state foo
note "This is a floating note" as N1
@enduml
  
```



## 9.16 Note on link

You can put notes on state-transition or link, with `note on link` keyword.

```

@startuml
[*] -> State1
State1 --> State2
note on link
    this is a state-transition note
end note
@enduml
  
```

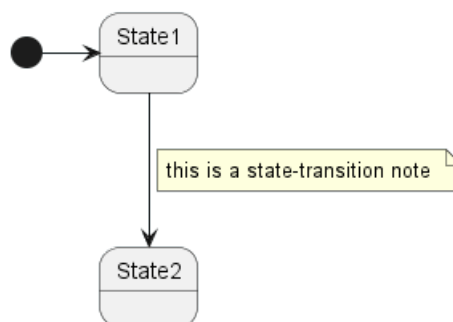

## 9.17 More in notes

You can put notes on composite states.

```

@startuml
[*] --> NotShooting

state "Not Shooting State" as NotShooting {
    state "Idle mode" as Idle
    state "Configuring mode" as Configuring
  }
  
```



```

[*] --> Idle
Idle --> Configuring : EvConfig
Configuring --> Idle : EvConfig
}

note right of NotShooting : This is a note on a composite state

@enduml

```

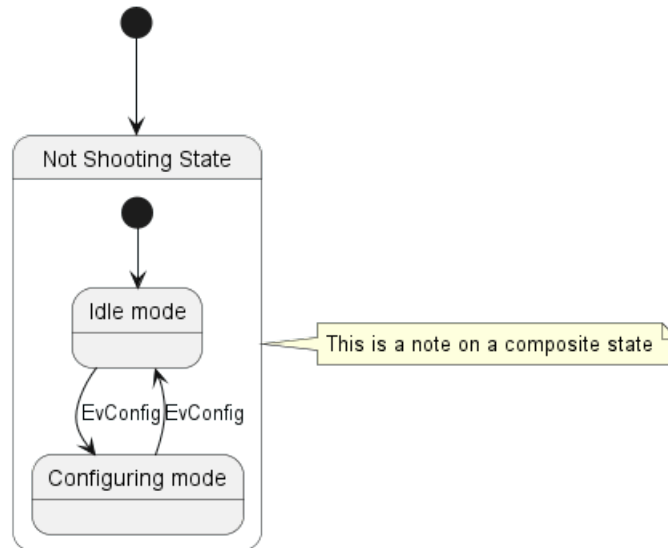

## 9.18 Inline color

```

@startuml
state CurrentSite #pink {
  state HardwareSetup #lightblue {
    state Site #brown
    Site -[hidden]-> Controller
    Controller -[hidden]-> Devices
  }
  state PresentationSetup{
    Groups -[hidden]-> PlansAndGraphics
  }
  state Trends #FFFF77
  state Schedule #magenta
  state AlarmSupression
}
@enduml

```

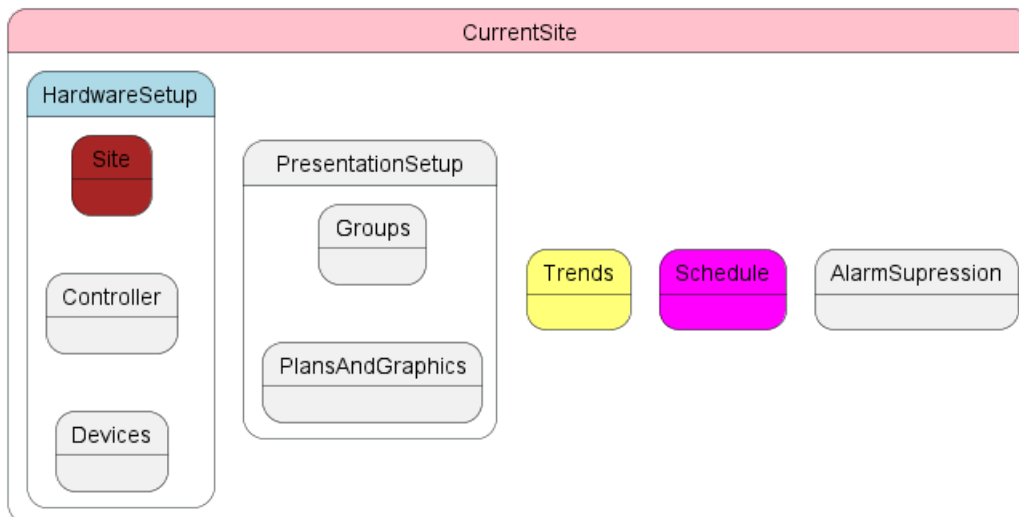

[Ref. QA-1812]

## 9.19 Skinparam

You can use the skinparam command to change colors and fonts for the drawing.

You can use this command :

- In the diagram definition, like any other commands,
- In an included file,
- In a configuration file, provided in the command line or the Ant task.

You can define specific color and fonts for stereotyped states.

```
@startuml
skinparam backgroundColor LightYellow
skinparam state {
  StartColor MediumBlue
  EndColor Red
  BackgroundColor Peru
  BackgroundColor<<Warning>> Olive
  BorderColor Gray
  FontName Impact
}

[*] --> NotShooting

state "Not Shooting State" as NotShooting {
  state "Idle mode" as Idle <<Warning>>
  state "Configuring mode" as Configuring
  [*] --> Idle
  Idle --> Configuring : EvConfig
  Configuring --> Idle : EvConfig
}

NotShooting --> [*]
@enduml
```

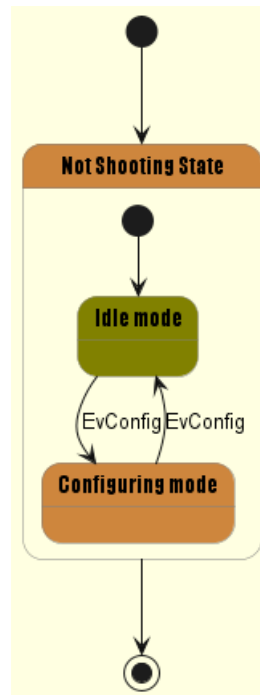

### 9.19.1 Test of all specific skinparam to State Diagrams

```
@startuml
skinparam State {
  AttributeFontColor blue
  AttributeFontName serif
  AttributeFontSize 9
  AttributeFontStyle italic
  BackgroundColor palegreen
  BorderColor violet
  EndColor gold
  FontColor red
  FontName Sanserif
  FontSize 15
  FontStyle bold
  StartColor silver
}

```

```
state A : a a a\na
state B : b b b\nb

```

```
[*] -> A : start
A -> B : a2b
B -> [*] : end
@enduml

```

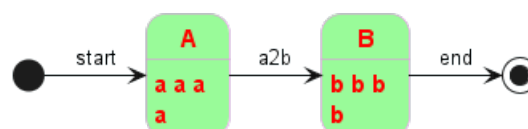

## 9.20 Changing style

You can change style.

```
@startuml

```

```

<style>
stateDiagram {
  BackgroundColor Peru
  'LineColor Gray
  FontName Impact
  FontColor Red
  arrow {
    FontSize 13
    LineColor Blue
  }
}
</style>

```

```

[*] --> NotShooting

```

```

state "Not Shooting State" as NotShooting {
  state "Idle mode" as Idle <<Warning>>
  state "Configuring mode" as Configuring
  [*] --> Idle
  Idle --> Configuring : EvConfig
  Configuring --> Idle : EvConfig
}

```

```

NotShooting --> [*]
@enduml

```

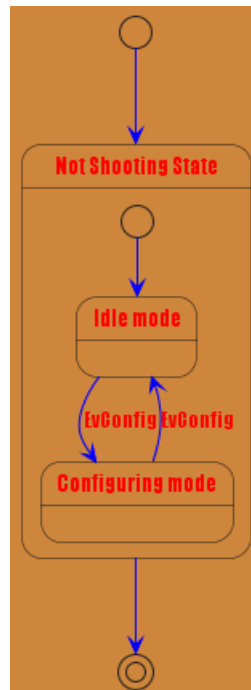

```

@startuml
<style>
  diamond {
    BackgroundColor #palegreen
    LineColor #green
    LineThickness 2.5
  }
</style>
state state1

```



```

state state2
state choice1 <<choice>>
state end3    <<end>>

state1 --> choice1 : 1
choice1 --> state2 : 2
choice1 --> end3   : 3
@enduml

```

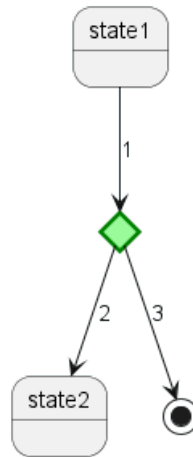

[Ref. GH-880]

## 9.21 Change state color and style (inline style)

You can change the color or style of individual state using the following notation:

- #color ##[style]color

With background color first (#color), then line style and line color (##[style]color ).

```

@startuml
state FooGradient #red-green ##00FFFF
state FooDashed #red|green ##[dashed]blue {
}
state FooDotted ##[dotted]blue {
}
state FooBold ##[bold] {
}
state Foo1 ##[dotted]green {
state inner1 ##[dotted]yellow
}

state out ##[dotted]gold

state Foo2 ##[bold]green {
state inner2 ##[dotted]yellow
}
inner1 -> inner2
out -> inner2
@enduml

```



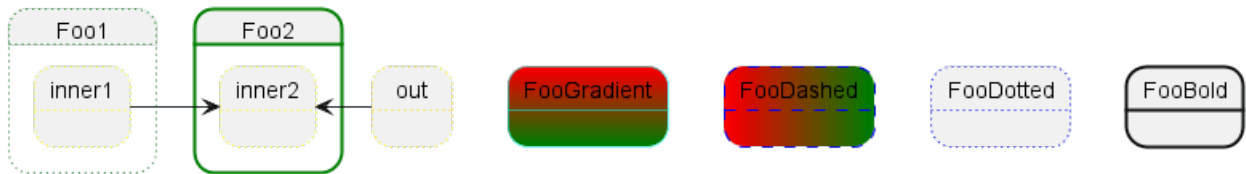

[Ref. QA-1487]

- #color;line:color;line.[bold|dashed|dotted];text:color

**TODO: FIXME** text:color seems not to be taken into account **TODO: FIXME**

```

@startuml
@startuml
state FooGradient #red-green;line:00FFFF
state FooDashed #red|green;line.dashed;line:blue {
}
state FooDotted #line.dotted;line:blue {
}
state FooBold #line.bold {
}
state Foo1 #line.dotted;line:green {
state inner1 #line.dotted;line:yellow
}

state out #line.dotted;line:gold

state Foo2 #line.bold;line:green {
state inner2 #line.dotted;line:yellow
}
inner1 -> inner2
out -> inner2
@enduml
@enduml

```

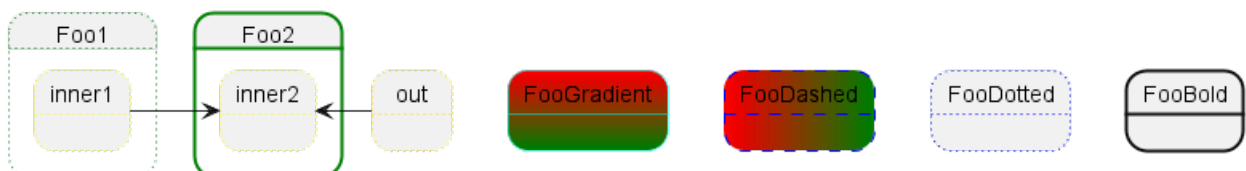

```

@startuml
state s1 : s1 description
state s2 #pink;line:red;line.bold;text:red : s2 description
state s3 #palegreen;line:green;line.dashed;text:green : s3 description
state s4 #aliceblue;line:blue;line.dotted;text:blue : s4 description
@enduml

```



[Adapted from QA-3770]

## 9.22 Alias

With State you can use alias, like:

```

@startuml
state alias1

```



```

state "alias2"
state "long name" as alias3
state alias4 as "long name"

alias1 : ""state alias1""
alias2 : ""state "alias2"""
alias3 : ""state "long name" as alias3""
alias4 : ""state alias4 as "long name"""

alias1 -> alias2
alias2 -> alias3
alias3 -> alias4
@enduml

```

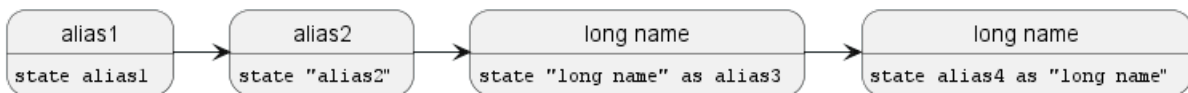

or:

```

@startuml
state alias1 : ""state alias1""
state "alias2" : ""state "alias2"""
state "long name" as alias3 : ""state "long name" as alias3""
state alias4 as "long name" : ""state alias4 as "long name"""

alias1 -> alias2
alias2 -> alias3
alias3 -> alias4
@enduml

```

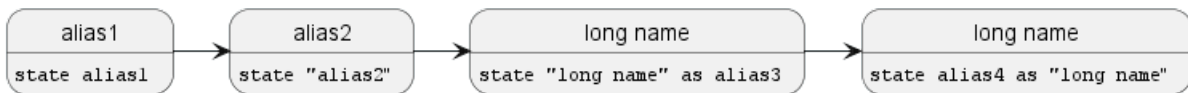

## 9.23 Display JSON Data on State diagram

### 9.23.1 Simple example

```

@startuml
state "A" as stateA
state "C" as stateC {
    state B
}

json jsonJ {
    "fruit": "Apple",
    "size": "Large",
    "color": ["Red", "Green"]
}
@enduml

```

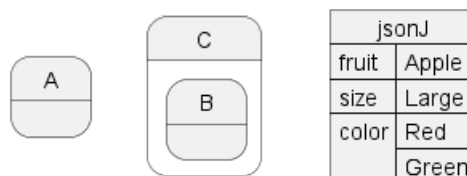

[Ref. QA-17275]

For another example, see on JSON page.





## 10 Timing Diagram

This is still under construction. You can propose new features if you need some.

### 10.1 Declaring element or participant

You declare participant using the following keywords, depending on how you want them to be drawn.

Keyword	Description
<code>analog</code>	An <b>analog</b> signal is continuous, and the values are linearly interpolated between the given setpoints
<code>binary</code>	A <b>binary</b> signal restricted to only 2 states
<code>clock</code>	A <b>clocked</b> signal that repeatedly transitions from high to low, with a <b>period</b> , and an optional <b>pulse</b> and <b>offset</b>
<code>concise</code>	A simplified <b>concise</b> signal designed to show the movement of data (great for messages)
<code>robust</code>	A <b>robust</b> complex line signal designed to show the transition from one state to another (can have many s

You define state change using the @ notation, and the is verb.

```
@startuml
robust "Web Browser" as WB
concise "Web User" as WU

@0
WU is Idle
WB is Idle

@100
WU is Waiting
WB is Processing

@300
WB is Waiting
@enduml
```

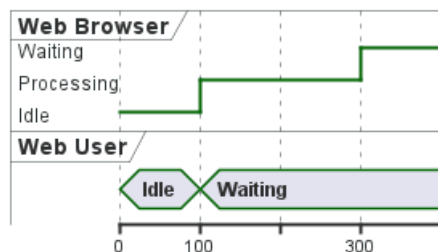

```
@startuml
clock "Clock_0" as C0 with period 50
clock "Clock_1" as C1 with period 50 pulse 15 offset 10
binary "Binary" as B
concise "Concise" as C
robust "Robust" as R
analog "Analog" as A

@0
C is Idle
R is Idle
A is 0

@100
B is high
C is Waiting
R is Processing
```



```

A is 3
@300
R is Waiting
A is 1
@enduml

```

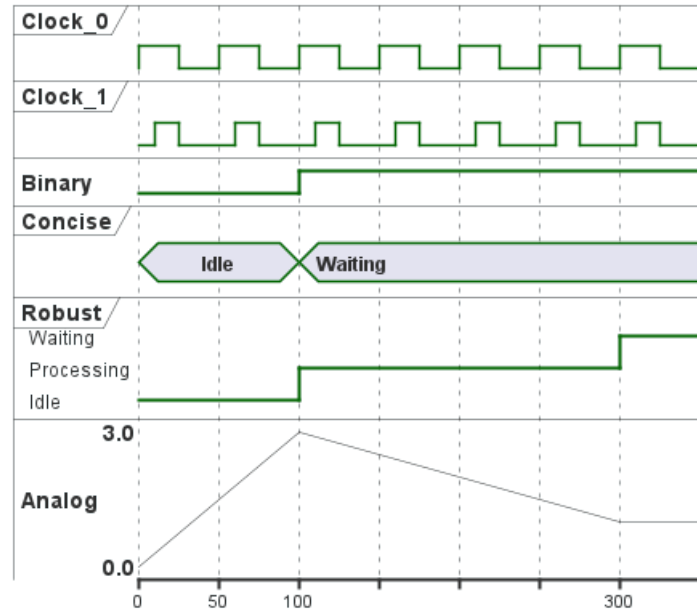

[Ref. QA-14631, QA-14647 and QA-11288]

## 10.2 Binary and Clock

It's also possible to have binary and clock signal, using the following keywords:

- binary
- clock

```

@startuml
clock clk with period 1
binary "Enable" as EN

```

```

@0
EN is low

```

```

@5
EN is high

```

```

@10
EN is low
@enduml

```

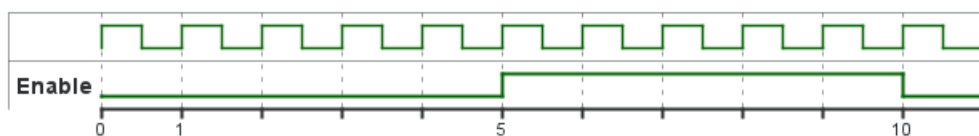

## 10.3 Adding message

You can add message using the following syntax.

```

@startuml
robust "Web Browser" as WB
concise "Web User" as WU

@0
WU is Idle
WB is Idle

@100
WU -> WB : URL
WU is Waiting
WB is Processing

@300
WB is Waiting
@enduml

```

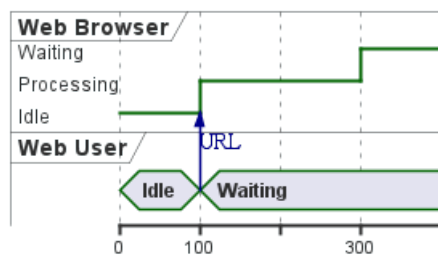

## 10.4 Relative time

It is possible to use relative time with @.

```

@startuml
robust "DNS Resolver" as DNS
robust "Web Browser" as WB
concise "Web User" as WU

@0
WU is Idle
WB is Idle
DNS is Idle

@+100
WU -> WB : URL
WU is Waiting
WB is Processing

@+200
WB is Waiting
WB -> DNS@+50 : Resolve URL

@+100
DNS is Processing

@+300
DNS is Idle
@enduml

```

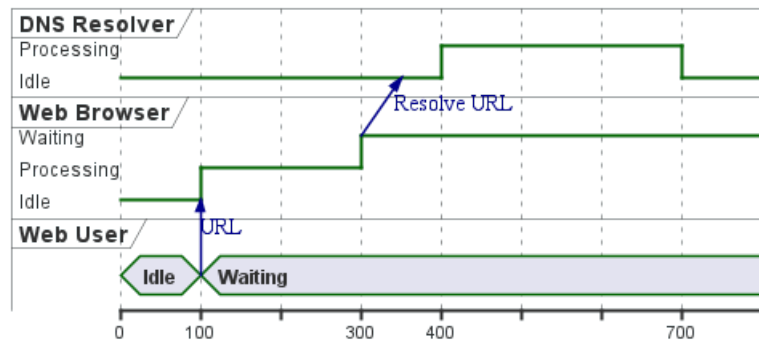

## 10.5 Anchor Points

Instead of using absolute or relative time on an absolute time you can define a time as an anchor point by using the `as` keyword and starting the name with a `:`.

```
@XX as :<anchor point name>
```

```
@startuml
clock clk with period 1
binary "enable" as EN
concise "dataBus" as db
```

```
@0 as :start
@5 as :en_high
@10 as :en_low
@:en_high-2 as :en_highMinus2
```

```
@:start
EN is low
db is "0x0000"
```

```
@:en_high
EN is high
```

```
@:en_low
EN is low
```

```
@:en_highMinus2
db is "0xf23a"
```

```
@:en_high+6
db is "0x0000"
@enduml
```

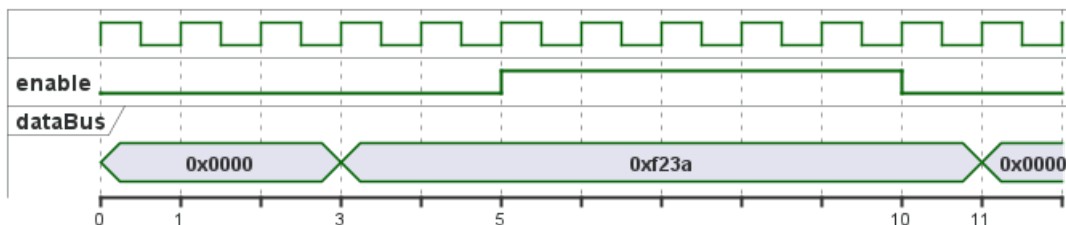

## 10.6 Participant oriented

Rather than declare the diagram in chronological order, you can define it by participant.

```
@startuml
```



```
robust "Web Browser" as WB
concise "Web User" as WU
```

```
@WB
0 is idle
+200 is Proc.
+100 is Waiting
```

```
@WU
0 is Waiting
+500 is ok
@enduml
```



## 10.7 Setting scale

You can also set a specific scale.

```
@startuml
concise "Web User" as WU
scale 100 as 50 pixels
```

```
@WU
0 is Waiting
+500 is ok
@enduml
```

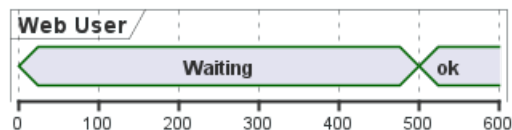

When using absolute Times/Dates, 1 "tick" is equivalent to 1 second.

```
@startuml
concise "Season" as S
'30 days is scaled to 50 pixels
scale 2592000 as 50 pixels
```

```
@2000/11/01
S is "Winter"
```

```
@2001/02/01
S is "Spring"
```

```
@2001/05/01
S is "Summer"
```

```
@2001/08/01
S is "Fall"
@enduml
```



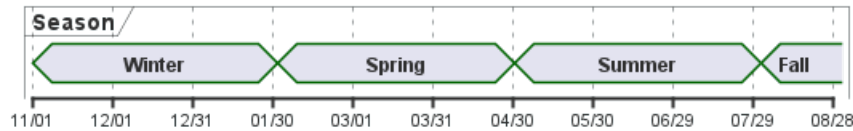

## 10.8 Initial state

You can also define an initial state.

```
@startuml
robust "Web Browser" as WB
concise "Web User" as WU
```

```
WB is Initializing
WU is Absent
```

```
@WB
0 is idle
+200 is Processing
+100 is Waiting
```

```
@WU
0 is Waiting
+500 is ok
@enduml
```



## 10.9 Intricated state

A signal could be in some undefined state.

### 10.9.1 Intricated or undefined robust state

```
@startuml
robust "Signal1" as S1
robust "Signal2" as S2
S1 has 0,1,2,hello
S2 has 0,1,2
@0
S1 is 0
S2 is 0
@100
S1 is {0,1} #SlateGrey
S2 is {0,1}
@200
S1 is 1
S2 is 0
@300
S1 is hello
```



```
S2 is {0,2}
@enduml
```

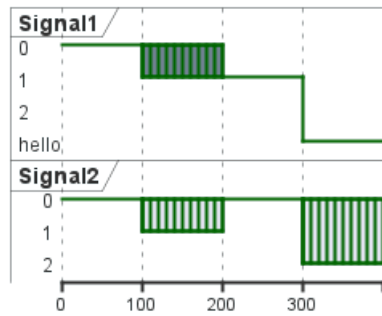

### 10.9.2 Intricated or undefined binary state

```
@startuml
clock "Clock" as C with period 2
binary "Enable" as EN
```

```
@0
EN is low
@1
EN is high
@3
EN is low
@5
EN is {low,high}
@10
EN is low
@enduml
```

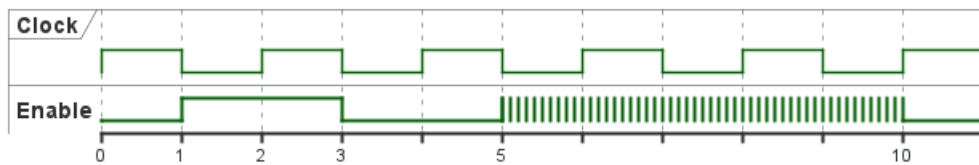

[Ref. QA-11936 and QA-15933]

## 10.10 Hidden state

It is also possible to hide some state.

```
@startuml
concise "Web User" as WU
```

```
@0
WU is {-}

@100
WU is A1

@200
WU is {-}

@300
WU is {hidden}
```



```

@400
WU is A3

@500
WU is {-}
@enduml

```

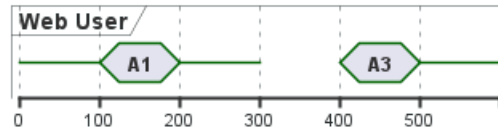

```

@startuml
scale 1 as 50 pixels

concise state0
concise substate1
robust bit2

```

```
bit2 has HIGH,LOW
```

```

@state0
0 is 18_start
6 is s_dPause
8 is 10_data
14 is {hidden}

```

```

@substate1
0 is sSeq
4 is sPause
6 is {hidden}
8 is dSeq
12 is dPause
14 is {hidden}

```

```

@bit2
0 is HIGH
2 is LOW
4 is {hidden}
8 is HIGH
10 is LOW
12 is {hidden}
@enduml

```

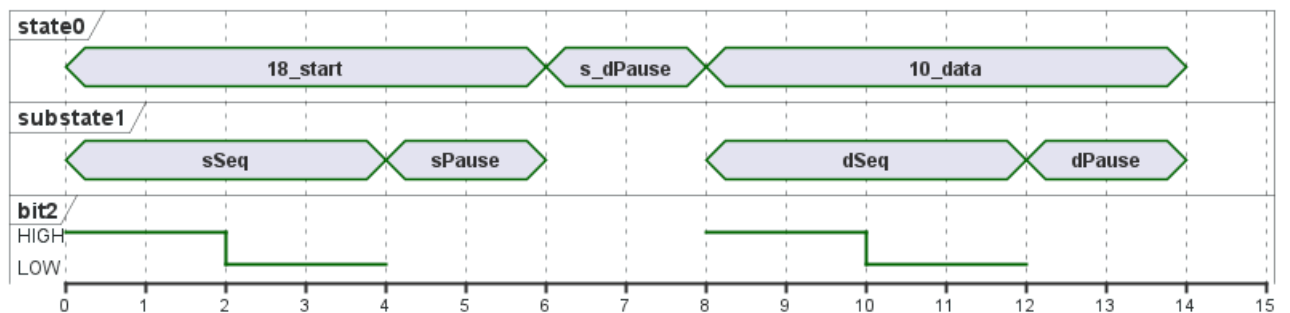

[Ref. QA-12222]





## 10.11 Hide time axis

It is possible to hide time axis.

```
@startuml
hide time-axis
concise "Web User" as WU
```

```
WU is Absent
```

```
@WU
0 is Waiting
+500 is ok
@enduml
```

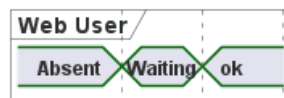

## 10.12 Using Time and Date

It is possible to use time or date.

```
@startuml
robust "Web Browser" as WB
concise "Web User" as WU
```

```
@2019/07/02
WU is Idle
WB is Idle
```

```
@2019/07/04
WU is Waiting : some note
WB is Processing : some other note
```

```
@2019/07/05
WB is Waiting
@enduml
```

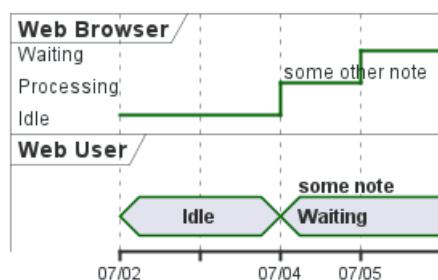

```
@startuml
robust "Web Browser" as WB
concise "Web User" as WU
```

```
@1:15:00
WU is Idle
WB is Idle
```

```
@1:16:30
WU is Waiting : some note
WB is Processing : some other note
```



```
@1:17:30
WB is Waiting
@enduml
```

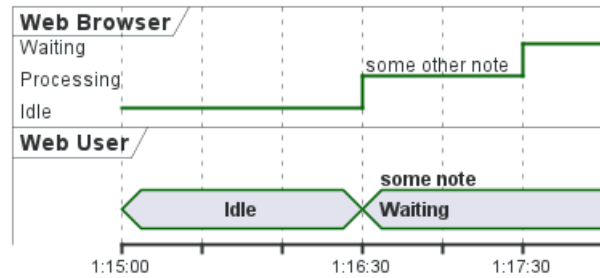

### 10.13 Adding constraint

It is possible to display time constraints on the diagrams.

```
@startuml
robust "Web Browser" as WB
concise "Web User" as WU
```

```
WB is Initializing
WU is Absent
```

```
@WB
0 is idle
+200 is Processing
+100 is Waiting
WB@0 <-> @50 : {50 ms lag}
```

```
@WU
0 is Waiting
+500 is ok
@200 <-> @+150 : {150 ms}
@enduml
```

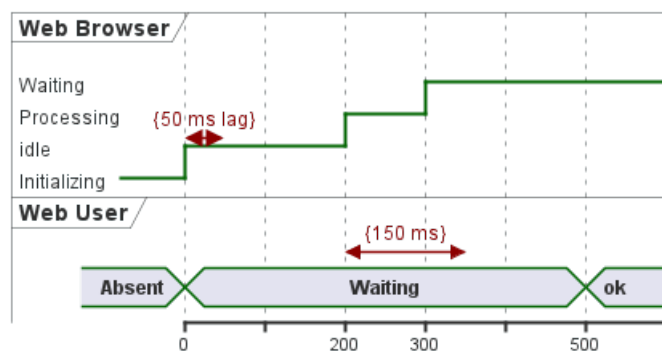

### 10.14 Highlighted period

You can highlight a part of diagram.

```
@startuml
robust "Web Browser" as WB
concise "Web User" as WU
```

```
@0
```



```

WU is Idle
WB is Idle

@100
WU -> WB : URL
WU is Waiting #LightCyan;line:Aqua

@200
WB is Proc.

@300
WU -> WB@350 : URL2
WB is Waiting

@+200
WU is ok

@+200
WB is Idle

highlight 200 to 450 #Gold;line:DimGrey : This is my caption
highlight 600 to 700 : This is another\nhighlight
@enduml

```

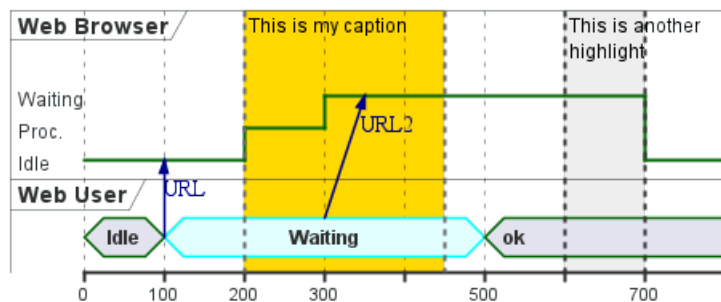

[Ref. QA-10868]

## 10.15 Using notes

You can use the `note top of` and `note bottom of` keywords to define notes related to a single object or participant (*available only for concise or binary object*).

```

@startuml
robust "Web Browser" as WB
concise "Web User" as WU

@0
WU is Idle
WB is Idle

@100
WU is Waiting
WB is Processing
note top of WU : first note\nnon several\nlines
note bottom of WU : second note\nnon several\nlines

@300
WB is Waiting
@enduml

```



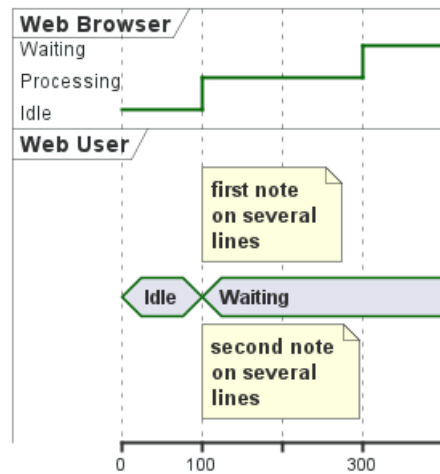

[Ref. QA-6877, GH-1465]

## 10.16 Adding texts

You can optionally add a title, a header, a footer, a legend and a caption:

```
@startuml
Title This is my title
header: some header
footer: some footer
legend
Some legend
end legend
caption some caption
```

```
robust "Web Browser" as WB
concise "Web User" as WU
```

```
@0
WU is Idle
WB is Idle
```

```
@100
WU is Waiting
WB is Processing
```

```
@300
WB is Waiting
@enduml
```



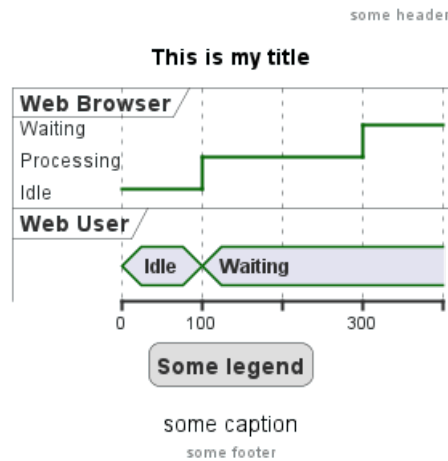

## 10.17 Complete example

Thanks to Adam Rosien for this example.

```

@startuml
concise "Client" as Client
concise "Server" as Server
concise "Response freshness" as Cache

Server is idle
Client is idle

@Client
0 is send
Client -> Server@+25 : GET
+25 is await
+75 is recv
+25 is idle
+25 is send
Client -> Server@+25 : GET\nIf-Modified-Since: 150
+25 is await
+50 is recv
+25 is idle
@100 <-> @275 : no need to re-request from server

@Server
25 is recv
+25 is work
+25 is send
Server -> Client@+25 : 200 OK\nExpires: 275
+25 is idle
+75 is recv
+25 is send
Server -> Client@+25 : 304 Not Modified
+25 is idle

@Cache
75 is fresh
+200 is stale
@enduml

```



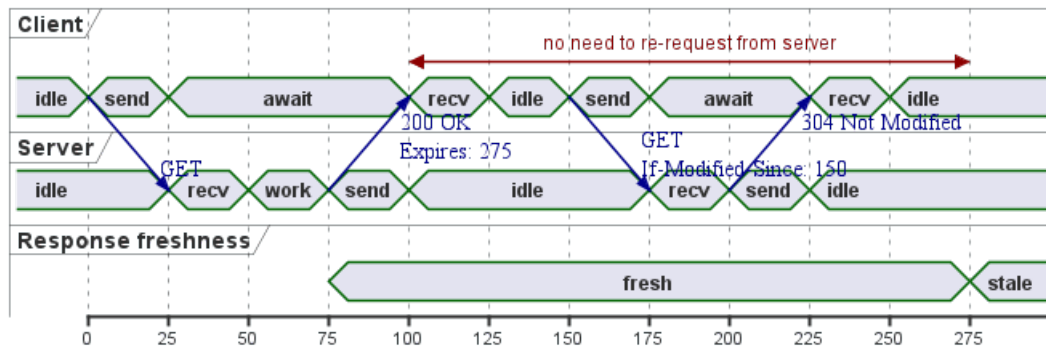

## 10.18 Digital Example

```
@startuml
scale 5 as 150 pixels

clock clk with period 1
binary "enable" as en
binary "R/W" as rw
binary "data Valid" as dv
concise "dataBus" as db
concise "address bus" as addr
```

```
@6 as :write_beg
@10 as :write_end
```

```
@15 as :read_beg
@19 as :read_end
```

```
@0
en is low
db is "0x0"
addr is "0x03f"
rw is low
dv is 0
```

```
@:write_beg-3
  en is high
@:write_beg-2
  db is "0xDEADBEEF"
@:write_beg-1
  dv is 1
@:write_beg
  rw is high
```

```
@:write_end
  rw is low
  dv is low
@:write_end+1
  rw is low
  db is "0x0"
  addr is "0x23"
```

```
@12
  dv is high
```



```

@13
db is "0xFFFF"

@20
en is low
dv is low
@21
db is "0x0"

highlight :write_beg to :write_end #Gold:Write
highlight :read_beg to :read_end #lightBlue:Read

db@:write_beg-1 <-> @:write_end : setup time
db@:write_beg-1 -> addr@:write_end+1 : hold
@enduml

```

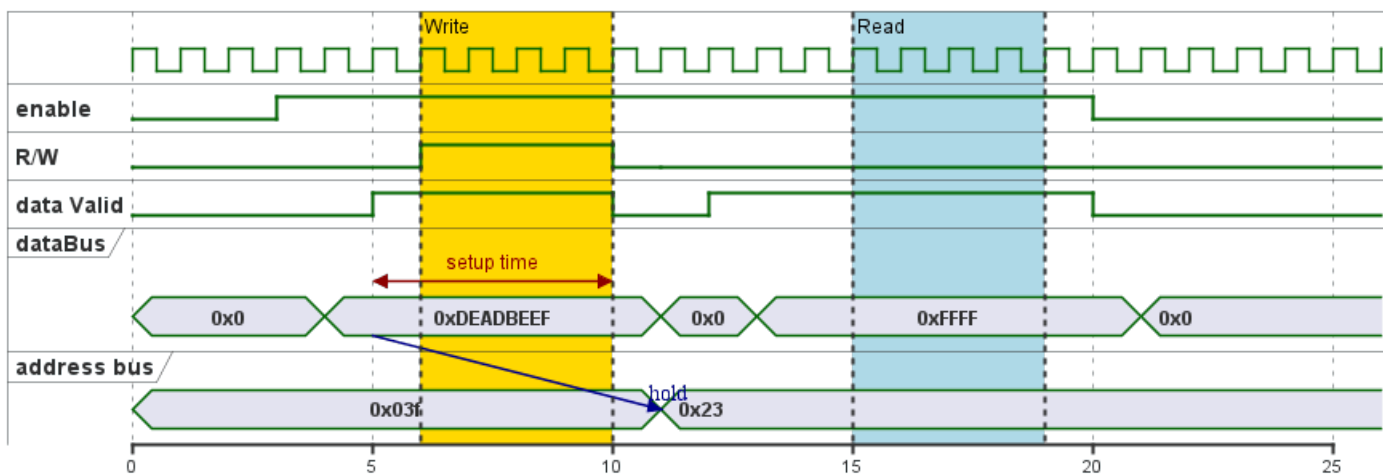

## 10.19 Adding color

You can add color.

```

@startuml
concise "LR" as LR
concise "ST" as ST

LR is AtPlace #palegreen
ST is AtLoad #gray

@LR
0 is Lowering
100 is Lowered #pink
350 is Releasing

@ST
200 is Moving
@enduml

```



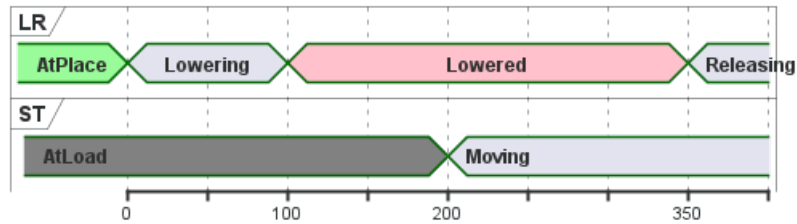

[Ref. QA-5776]

## 10.20 Using (global) style

### 10.20.1 Without style (by default)

```
@startuml
robust "Web Browser" as WB
concise "Web User" as WU
```

```
WB is Initializing
WU is Absent
```

```
@WB
0 is idle
+200 is Processing
+100 is Waiting
WB@0 <-> @50 : {50 ms lag}
```

```
@WU
0 is Waiting
+500 is ok
@200 <-> @+150 : {150 ms}
@enduml
```

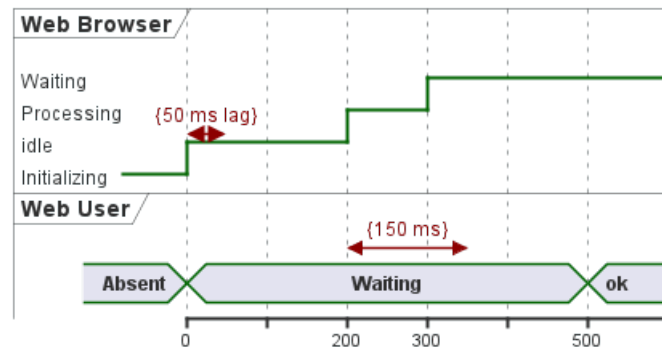

### 10.20.2 With style

You can use style to change rendering of elements.

```
@startuml
<style>
timingDiagram {
  document {
    BackGroundColor SandyBrown
  }
  constraintArrow {
   LineStyle 2-1
    LineThickness 3
    LineColor Blue
  }
}
```





```

}
}
</style>
robust "Web Browser" as WB
concise "Web User" as WU

WB is Initializing
WU is Absent

@WB
0 is idle
+200 is Processing
+100 is Waiting
WB@0 <-> @50 : {50 ms lag}

@WU
0 is Waiting
+500 is ok
@200 <-> @+150 : {150 ms}
@enduml

```

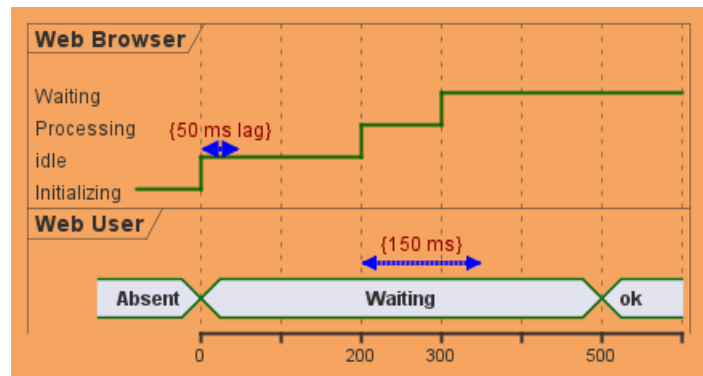

[Ref. QA-14340]

## 10.21 Applying Colors to specific lines

You can use the `<style>` tags and stereotyping to give a name to line attributes.

```

@startuml
<style>
timingDiagram {
  .red {
    LineColor red
  }
  .blue {
    LineColor blue
    LineThickness 5
  }
}
</style>

clock clk with period 1
binary "Input Signal 1" as IS1
binary "Input Signal 2" as IS2 <<blue>>
binary "Output Signal 1" as OS1 <<red>>

@0
IS1 is low

```



```

IS2 is high
OS1 is low
@2
OS1 is high
@4
OS1 is low
@5
IS1 is high
OS1 is high
@6
IS2 is low
@10
IS1 is low
OS1 is low
@enduml

```

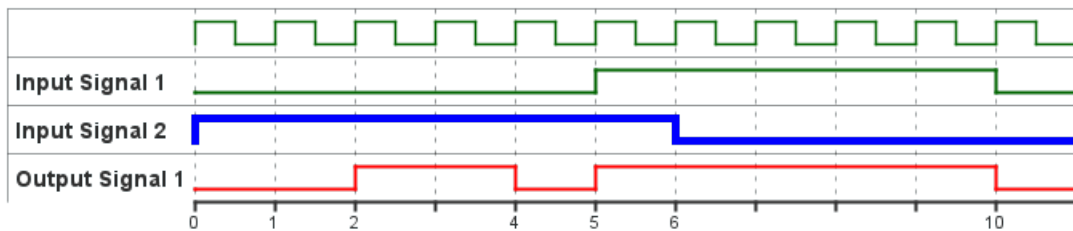

[Ref. QA-15870]

## 10.22 Compact mode

You can use compact command to compact the timing layout.

### 10.22.1 By default

```

@startuml
robust "Web Browser" as WB
concise "Web User" as WU
robust "Web Browser2" as WB2

@0
WU is Waiting
WB is Idle
WB2 is Idle

@200
WB is Proc.

@300
WB is Waiting
WB2 is Waiting

@500
WU is ok

@700
WB is Idle
@enduml

```



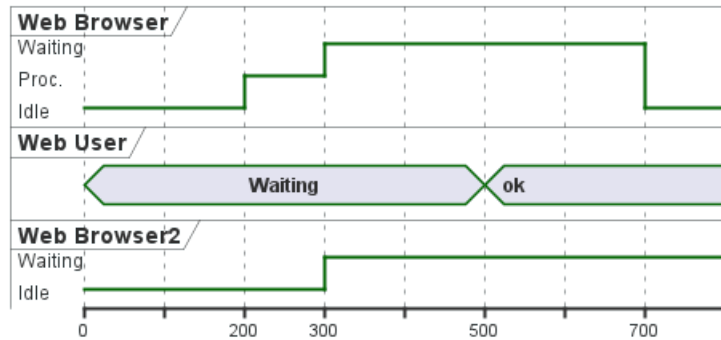

### 10.22.2 Global mode with mode compact

```

@startuml
mode compact
robust "Web Browser" as WB
concise "Web User" as WU
robust "Web Browser2" as WB2

@0
WU is Waiting
WB is Idle
WB2 is Idle

@200
WB is Proc.

@300
WB is Waiting
WB2 is Waiting

@500
WU is ok

@700
WB is Idle
@enduml

```

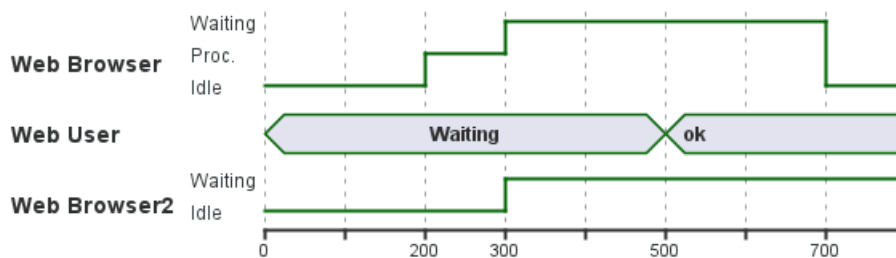

### 10.22.3 Local mode with only compact on element

```

@startuml
compact robust "Web Browser" as WB
compact concise "Web User" as WU
robust "Web Browser2" as WB2

@0
WU is Waiting
WB is Idle

```



```

WB2 is Idle

@200
WB is Proc.

@300
WB is Waiting
WB2 is Waiting

@500
WU is ok

@700
WB is Idle
@enduml
    
```

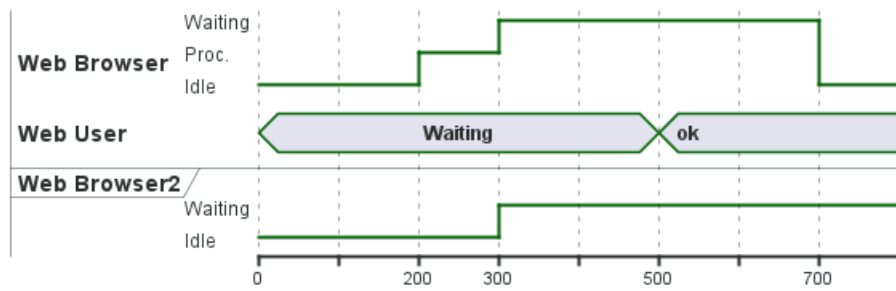

[Ref. QA-11130]

## 11 Display JSON Data

JSON format is widely used in software.

You can use PlantUML to visualize your data.

To activate this feature, the diagram must:

- begin with `@startjson` keyword
- end with `@endjson` keyword.

```
@startjson
{
  "fruit": "Apple",
  "size": "Large",
  "color": ["Red", "Green"]
}
@endjson
```

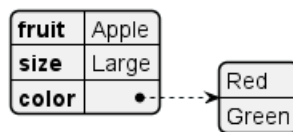

### 11.1 Complex example

You can use complex JSON structure.

```
@startjson
{
  "firstName": "John",
  "lastName": "Smith",
  "isAlive": true,
  "age": 27,
  "address": {
    "streetAddress": "21 2nd Street",
    "city": "New York",
    "state": "NY",
    "postalCode": "10021-3100"
  },
  "phoneNumbers": [
    {
      "type": "home",
      "number": "212 555-1234"
    },
    {
      "type": "office",
      "number": "646 555-4567"
    }
  ],
  "children": [],
  "spouse": null
}
@endjson
```



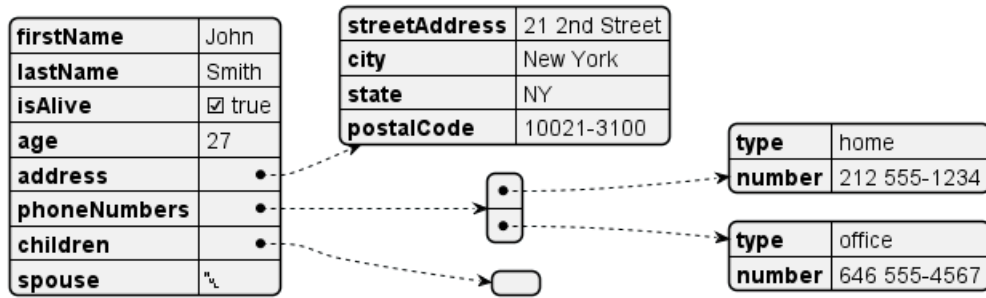

## 11.2 Highlight parts

```

@startjson
#highlight "lastName"
#highlight "address" / "city"
#highlight "phoneNumbers" / "0" / "number"
{
  "firstName": "John",
  "lastName": "Smith",
  "isAlive": true,
  "age": 28,
  "address": {
    "streetAddress": "21 2nd Street",
    "city": "New York",
    "state": "NY",
    "postalCode": "10021-3100"
  },
  "phoneNumbers": [
    {
      "type": "home",
      "number": "212 555-1234"
    },
    {
      "type": "office",
      "number": "646 555-4567"
    }
  ],
  "children": [],
  "spouse": null
}
@endjson

```

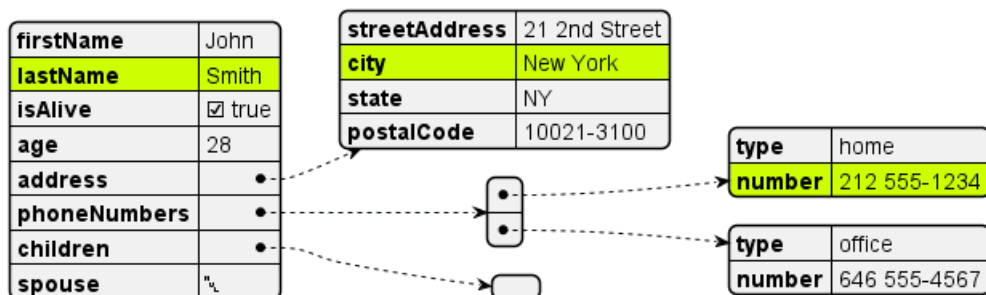

## 11.3 Using different styles for highlight

It is possible to have different styles for different highlights.

```
@startjson
```



```

<style>
  .h1 {
    BackGroundColor green
    FontColor white
    FontStyle italic
  }
  .h2 {
    BackGroundColor red
    FontColor white
    FontStyle bold
  }
</style>
#highlight "lastName"
#highlight "address" / "city" <<h1>>
#highlight "phoneNumbers" / "0" / "number" <<h2>>
{
  "firstName": "John",
  "lastName": "Smith",
  "isAlive": true,
  "age": 28,
  "address": {
    "streetAddress": "21 2nd Street",
    "city": "New York",
    "state": "NY",
    "postalCode": "10021-3100"
  },
  "phoneNumbers": [
    {
      "type": "home",
      "number": "212 555-1234"
    },
    {
      "type": "office",
      "number": "646 555-4567"
    }
  ],
  "children": [],
  "spouse": null
}
@endjson

```

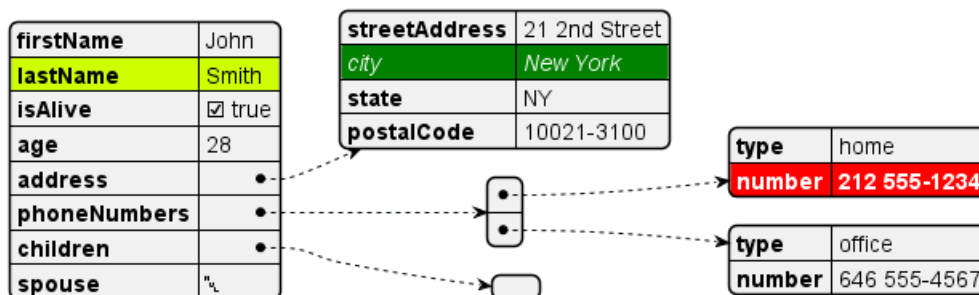

[Ref. QA-15756, GH-1393]

## 11.4 JSON basic element

### 11.4.1 Synthesis of all JSON basic element

```

@startjson
{

```



```

>null": null,
>true": true,
>false": false,
>JSON_Number": [-1, -1.1, "<color:green>TBC"],
>JSON_String": "a\nb\rc\td <color:green>TBC...",
>JSON_Object": {
>  "{}": {},
>  "k_int": 123,
>  "k_str": "abc",
>  "k_obj": {"k": "v"}
>},
>JSON_Array" : [
>  [],
>  [true, false],
>  [-1, 1],
>  ["a", "b", "c"],
>  ["mix", null, true, 1, {"k": "v"}]
>]
>}
>@endjson

```

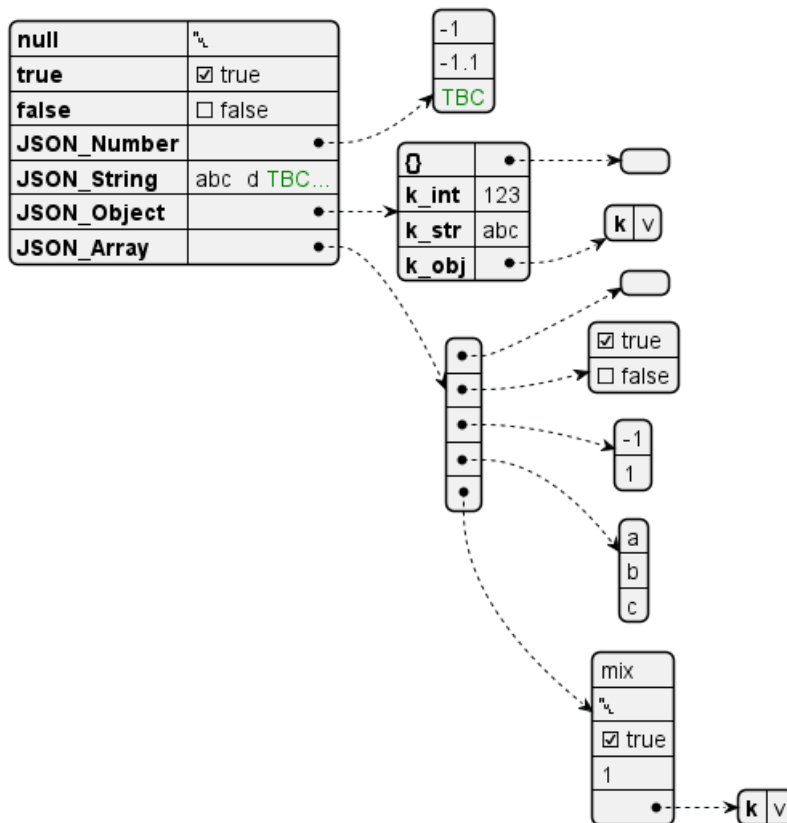

## 11.5 JSON array or table

### 11.5.1 Array type

```

>@startjson
>{
>  "Numeric": [1, 2, 3],
>  "String " : ["v1a", "v2b", "v3c"],
>  "Boolean": [true, false, true]
>}
>@endjson

```





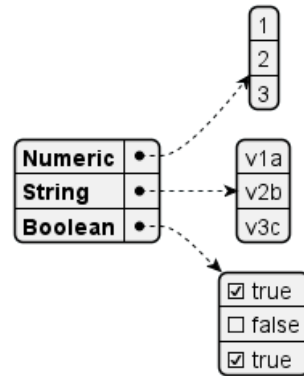

### 11.5.2 Minimal array or table

### 11.5.3 Number array

```
@startjson
[1, 2, 3]
@endjson
```

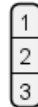

### 11.5.4 String array

```
@startjson
["1a", "2b", "3c"]
@endjson
```

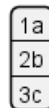

### 11.5.5 Boolean array

```
@startjson
[true, false, true]
@endjson
```

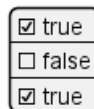

## 11.6 JSON numbers

```
@startjson
{
  "DecimalNumber": [-1, 0, 1],
  "DecimalNumber . Digits": [-1.1, 0.1, 1.1],
  "DecimalNumber ExponentPart": [1E5]
}
@endjson
```

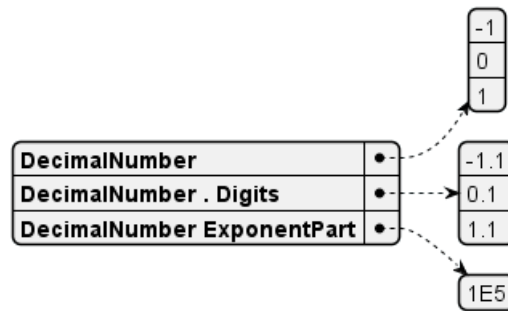

## 11.7 JSON strings

### 11.7.1 JSON Unicode

On JSON you can use Unicode directly or by using escaped form like .

```
@startjson
{
  "<color:blue><b>code": "<color:blue><b>value",
  "a\u005Cb":      "a\u005Cb",
  "\uD83D\uDE10": "\uD83D\uDE10",
  " ":             " "
}
@endjson
```

code	value
a\u005Cb	a\b
\uD83D\uDE10	😄
😊	😊

### 11.7.2 JSON two-character escape sequence

```
@startjson
{
  "**legend**: character name":      ["**two-character escape sequence**", "example (between
  "quotation mark character (U+0022)": ["\\\"", "a\"b"],
  "reverse solidus character (U+005C)": ["\\\"", "a\\b"],
  "solidus character (U+002F)":       ["\\\/", "a\/b"],
  "backspace character (U+0008)":     ["\\b", "a\\bb"],
  "form feed character (U+000C)":     ["\\f", "a\\fb"],
  "line feed character (U+000A)":     ["\\n", "a\\nb"],
  "carriage return character (U+000D)": ["\\r", "a\\rb"],
  "character tabulation character (U+0009)": ["\\t", "a\\tb"]
}
@endjson
```

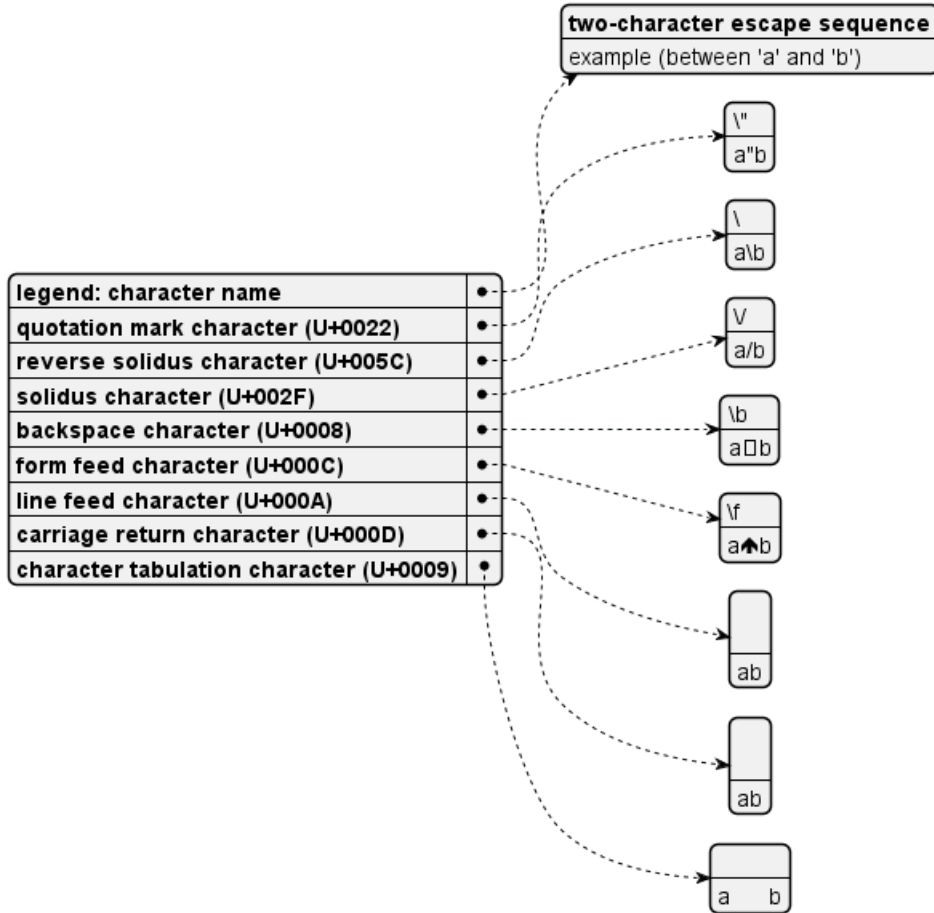

**TODO:** FIXME FIXME or not , on the same item as management in PlantUML *See Report Bug on QA-13066* **TODO:** FIXME

```
@startjson
[
  "\\\\",
  "\\n",
  "\\r",
  "\\t"
]
@endjson
```

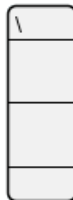

## 11.8 Minimal JSON examples

```
@startjson
"Hello world!"
@endjson
```

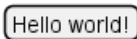

```
@startjson
42
@endjson
```



```
@startjson
true
@endjson
```



(Examples come from STD 90 - Examples)

## 11.9 Empty table or list

```
@startjson
{
  "empty_tab": [],
  "empty_list": {}
}
@endjson
```



[Ref. QA-14397]

## 11.10 Using (global) style

### 11.10.1 Without style (by default)

```
@startjson
#highlight "1" / "hr"
[
  {
    "name": "Mark McGwire",
    "hr": 65,
    "avg": 0.278
  },
  {
    "name": "Sammy Sosa",
    "hr": 63,
    "avg": 0.288
  }
]
@endjson
```

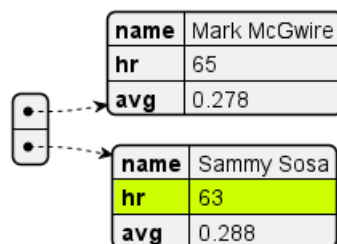

### 11.10.2 With style

You can use style to change rendering of elements.

```
@startjson
<style>
jsonDiagram {
  node {
    BackGroundColor Khaki
    LineColor lightblue
    FontName Helvetica
    FontColor red
    FontSize 18
    FontStyle bold
    RoundCorner 0
    LineThickness 2
    LineStyle 10-5
    separator {
      LineThickness 0.5
      LineColor black
      LineStyle 1-5
    }
  }
  arrow {
    BackGroundColor lightblue
    LineColor green
    LineThickness 2
    LineStyle 2-5
  }
  highlight {
    BackGroundColor red
    FontColor white
    FontStyle italic
  }
}
</style>
#highlight "1" / "hr"
[
  {
    "name": "Mark McGwire",
    "hr": 65,
    "avg": 0.278
  },
  {
    "name": "Sammy Sosa",
    "hr": 63,
    "avg": 0.288
  }
]
@endjson
```

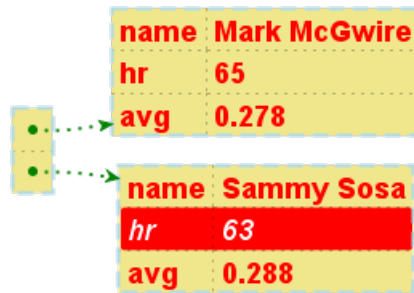

[Adapted from QA-13123 and QA-13288]

## 11.11 Display JSON Data on Class or Object diagram

### 11.11.1 Simple example

```
@startuml
class Class
object Object
json JSON {
  "fruit": "Apple",
  "size": "Large",
  "color": ["Red", "Green"]
}
@enduml
```

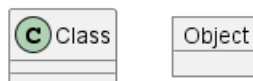

JSON	
fruit	Apple
size	Large
color	Red
	Green

[Ref. QA-15481]

### 11.11.2 Complex example: with all JSON basic element

```
@startuml
json "<b>JSON basic element" as J {
  "null": null,
  "true": true,
  "false": false,
  "JSON_Number": [-1, -1.1, "<color:green>TBC"],
  "JSON_String": "\n\n\t\t <color:green>TBC...",
  "JSON_Object": {
    "{}": {},
    "k_int": 123,
    "k_str": "abc",
    "k_obj": {"k": "v"}
  },
  "JSON_Array" : [
    [],
    [true, false],
    [-1, 1],
  ]
}
```



```

["a", "b", "c"],
["mix", null, true, 1, {"k": "v"}]
]
}
@enduml

```

JSON basic element	
null	null
true	true
false	false
JSON_Number	-1
	-1.1
	TBC
JSON_String	abc d TBC...
JSON_Object	{}
	k_int   123
	k_str   abc
	k_obj   k   v
JSON_Array	true
	false
	-1
	1
	a
	b
	c
	mix
	null
	true
	1
	k   v

## 11.12 Display JSON Data on Deployment (Usecase, Component, Deployment) diagram

### 11.12.1 Simple example

```

@startuml
allowmixing

component Component
actor Actor
usecase Usecase
() Interface
node Node
cloud Cloud

json JSON {
    "fruit": "Apple",
    "size": "Large",
    "color": ["Red", "Green"]
}
@enduml

```

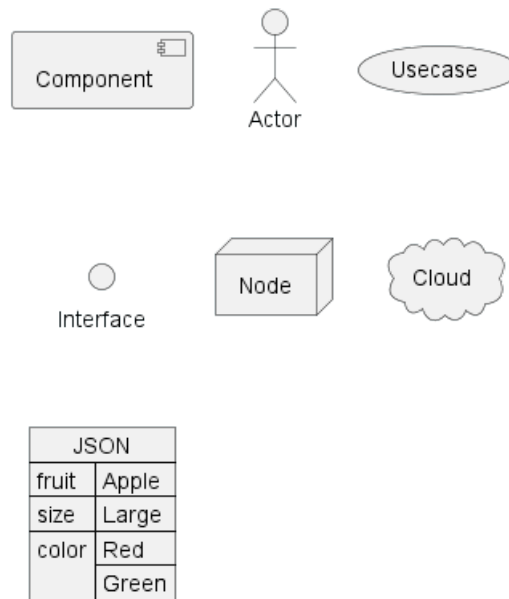

[Ref. QA-15481]

Complex example: with arrow

```

@startuml
allowmixing

agent Agent
stack {
  json "JSON_file.json" as J {
    "fruit":"Apple",
    "size":"Large",
    "color": ["Red", "Green"]
  }
}
database Database

Agent -> J
J -> Database
@enduml

```

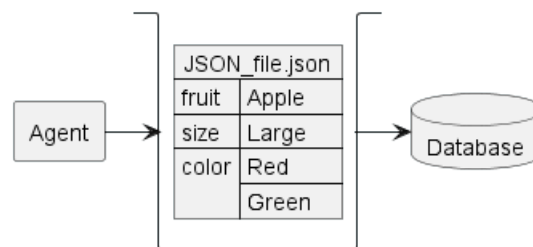

## 11.13 Display JSON Data on State diagram

### 11.13.1 Simple example

```

@startuml
state "A" as stateA
state "C" as stateC {
  state B
}

```





```
json J {  
    "fruit": "Apple",  
    "size": "Large",  
    "color": ["Red", "Green"]  
}  
@enduml
```

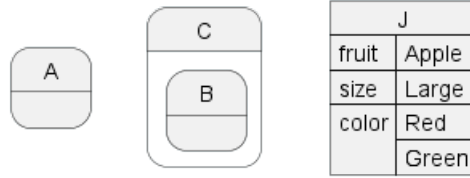

[Ref. QA-17275]

## 12 Display YAML Data

YAML format is widely used in software.

You can use PlantUML to visualize your data.

To activate this feature, the diagram must:

- begin with `@startyaml` keyword
- end with `@endyaml` keyword.

```
@startyaml
fruit: Apple
size: Large
color:
  - Red
  - Green
@endyaml
```

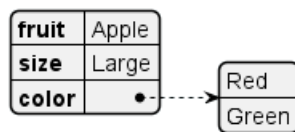

### 12.1 Complex example

```
@startyaml
doe: "a deer, a female deer"
ray: "a drop of golden sun"
pi: 3.14159
xmas: true
french-hens: 3
calling-birds:
  - huey
  - dewey
  - louie
  - fred
xmas-fifth-day:
calling-birds: four
french-hens: 3
golden-rings: 5
partridges:
count: 1
location: "a pear tree"
turtle-doves: two
@endyaml
```

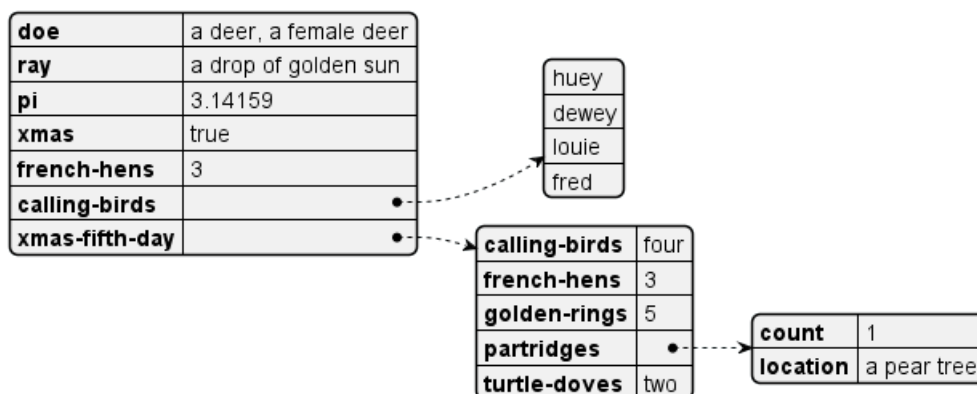

## 12.2 Specific key (with symbols or unicode)

```
@startyaml
@fruit: Apple
$size: Large
&color: Red
♥: Heart
%: Per mille
@endyaml
```

@fruit	Apple
\$size	Large
&color	Red
♥	Heart
%	Per mille

[Ref. QA-13376]

## 12.3 Highlight parts

### 12.3.1 Normal style

```
@startyaml
#highlight "french-hens"
#highlight "xmas-fifth-day" / "partridges"
```

```
doe: "a deer, a female deer"
ray: "a drop of golden sun"
pi: 3.14159
xmas: true
french-hens: 3
calling-birds:
- huey
- dewey
- louie
- fred
xmas-fifth-day:
calling-birds: four
french-hens: 3
golden-rings: 5
partridges:
count: 1
location: "a pear tree"
turtle-doves: two
@endyaml
```

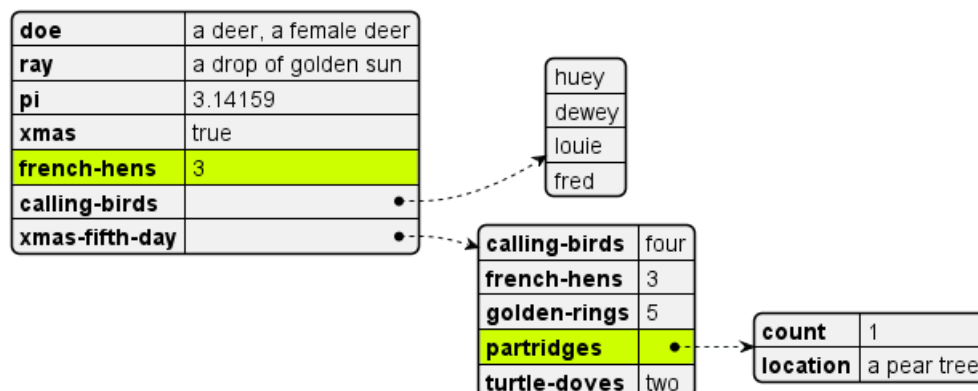

### 12.3.2 Customised style

```

@startyaml
<style>
yamlDiagram {
  highlight {
    BackGroundColor red
    FontColor white
    FontStyle italic
  }
}
</style>
#highlight "french-hens"
#highlight "xmas-fifth-day" / "partridges"

doe: "a deer, a female deer"
ray: "a drop of golden sun"
pi: 3.14159
xmas: true
french-hens: 3
calling-birds:
- huey
- dewey
- louie
- fred
xmas-fifth-day:
calling-birds: four
french-hens: 3
golden-rings: 5
partridges:
count: 1
location: "a pear tree"
turtle-doves: two
@endyaml

```

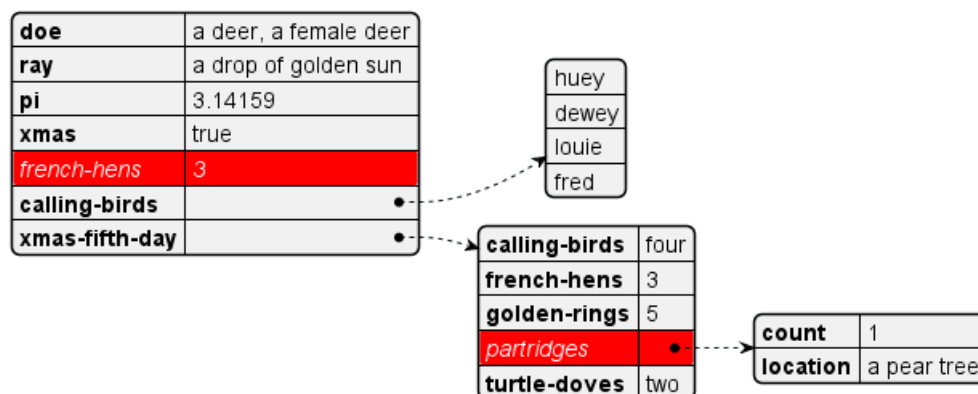

[Ref. QA-13288]

## 12.4 Using different styles for highlight

It is possible to have different styles for different highlights.

```

@startyaml
<style>
.h1 {
  BackGroundColor green
  FontColor white
}

```



```

    FontStyle italic
  }
  .h2 {
    BackGroundColor red
    FontColor white
    FontStyle italic
  }
</style>
#highlight "french-hens" <<h1>>
#highlight "xmas-fifth-day" / "partridges" <<h2>>

doe: "a deer, a female deer"
ray: "a drop of golden sun"
pi: 3.14159
xmas: true
french-hens: 3
calling-birds:
- huey
- dewey
- louie
- fred
xmas-fifth-day:
calling-birds: four
french-hens: 3
golden-rings: 5
partridges:
count: 1
location: "a pear tree"
turtle-doves: two
@endyaml

```

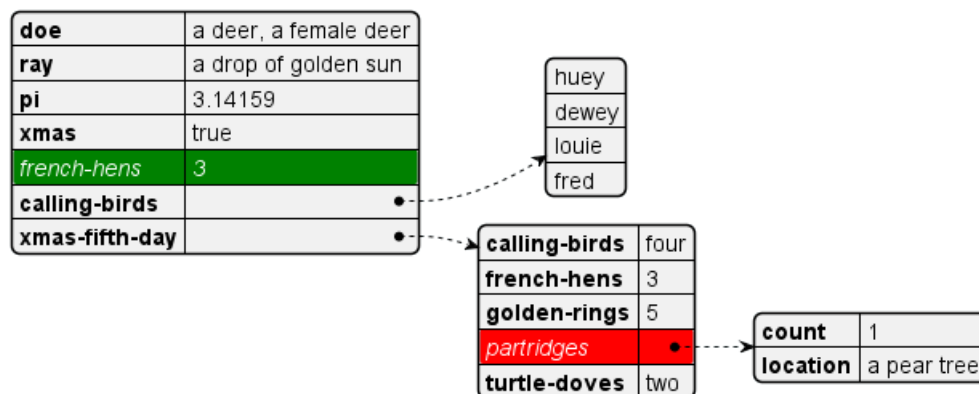

[Ref. QA-15756, GH-1393]

## 12.5 Using (global) style

### 12.5.1 Without style (by default)

```

@startyaml
-
  name: Mark McGwire
  hr: 65
  avg: 0.278
-
  name: Sammy Sosa
  hr: 63

```



```

    avg: 0.288
@endyaml

```

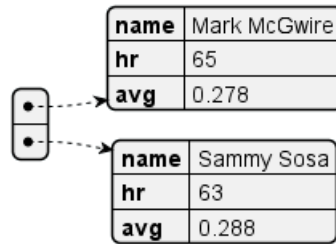

### 12.5.2 With style

You can use style to change rendering of elements.

```

@startyaml
<style>
yamlDiagram {
  node {
    BackGroundColor lightblue
    LineColor lightblue
    FontName Helvetica
    FontColor red
    FontSize 18
    FontStyle bold
    BackGroundColor Khaki
    RoundCorner 0
    LineThickness 2
    LineStyle 10-5
    separator {
      LineThickness 0.5
      LineColor black
      LineStyle 1-5
    }
  }
  arrow {
    BackGroundColor lightblue
    LineColor green
    LineThickness 2
    LineStyle 2-5
  }
}
</style>
-
  name: Mark McGwire
  hr: 65
  avg: 0.278
-
  name: Sammy Sosa
  hr: 63
  avg: 0.288
@endyaml

```

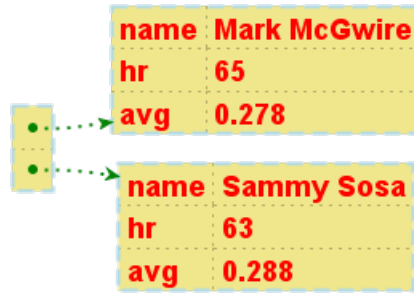

[Ref. QA-13123]

## 13 Network diagram (nwdiag)

nwdiag has been created by Takeshi Komiya and allows to quickly draw network diagrams. So we thank him for his creation!

Since the syntax is clear and simple, this has been integrated within PlantUML. We reuse here the examples that Takeshi has documented.

### 13.1 Simple diagram

#### 13.1.1 Define a network

```
@startuml
nwdiag {
  network dmz {
    address = "210.x.x.x/24"
  }
}
@enduml
```

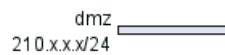

#### 13.1.2 Define some elements or servers on a network

```
@startuml
nwdiag {
  network dmz {
    address = "210.x.x.x/24"

    web01 [address = "210.x.x.1"];
    web02 [address = "210.x.x.2"];
  }
}
@enduml
```

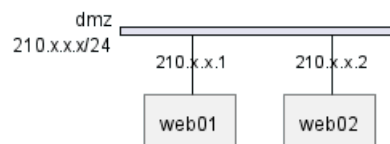

#### 13.1.3 Full example

```
@startuml
nwdiag {
  network dmz {
    address = "210.x.x.x/24"

    web01 [address = "210.x.x.1"];
    web02 [address = "210.x.x.2"];
  }
  network internal {
    address = "172.x.x.x/24";

    web01 [address = "172.x.x.1"];
    web02 [address = "172.x.x.2"];
  }
}
```





```

    db01;
    db02;
  }
}
@enduml

```

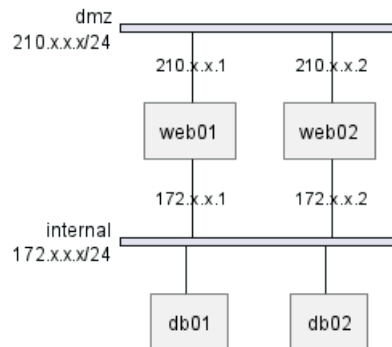

## 13.2 Define multiple addresses

```

@startuml
nwdiag {
  network dmz {
    address = "210.x.x.x/24"

    // set multiple addresses (using comma)
    web01 [address = "210.x.x.1, 210.x.x.20"];
    web02 [address = "210.x.x.2"];
  }
  network internal {
    address = "172.x.x.x/24";

    web01 [address = "172.x.x.1"];
    web02 [address = "172.x.x.2"];
    db01;
    db02;
  }
}
@enduml

```

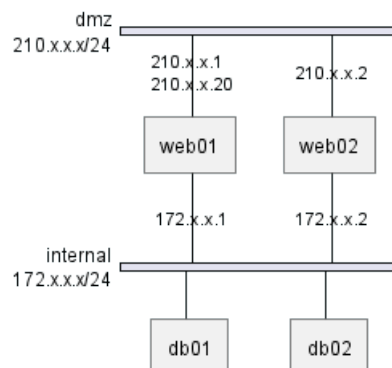

## 13.3 Grouping nodes

### 13.3.1 Define group inside network definitions

```

@startuml
nwdiag {
  network Sample_front {
    address = "192.168.10.0/24";

    // define group
    group web {
      web01 [address = ".1"];
      web02 [address = ".2"];
    }
  }
  network Sample_back {
    address = "192.168.20.0/24";
    web01 [address = ".1"];
    web02 [address = ".2"];
    db01 [address = ".101"];
    db02 [address = ".102"];

    // define network using defined nodes
    group db {
      db01;
      db02;
    }
  }
}
@enduml

```

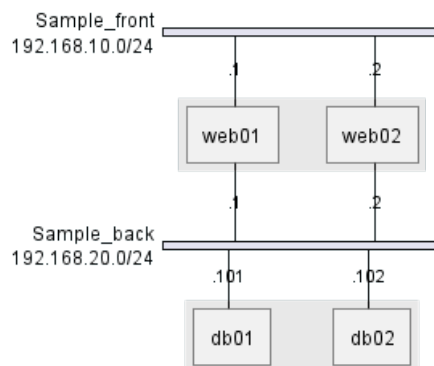

### 13.3.2 Define group outside of network definitions

```

@startuml
nwdiag {
  // define group outside of network definitions
  group {
    color = "#FFAAAA";

    web01;
    web02;
    db01;
  }

  network dmz {

```



```

    web01;
    web02;
  }
  network internal {
    web01;
    web02;
    db01;
    db02;
  }
}
@enduml

```

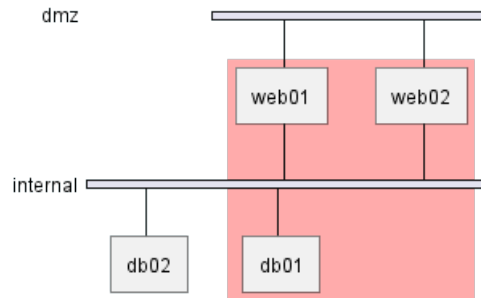

### 13.3.3 Define several groups on same network

#### 13.3.4 Example with 2 group

```

@startuml
nwdiag {
  group {
    color = "#FFaaaa";
    web01;
    db01;
  }
  group {
    color = "#aaaaFF";
    web02;
    db02;
  }
  network dmz {
    address = "210.x.x.x/24"

    web01 [address = "210.x.x.1"];
    web02 [address = "210.x.x.2"];
  }
  network internal {
    address = "172.x.x.x/24";

    web01 [address = "172.x.x.1"];
    web02 [address = "172.x.x.2"];
    db01 ;
    db02 ;
  }
}
@enduml

```

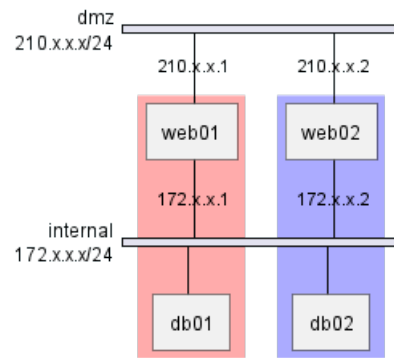

[Ref. QA-12663]

### 13.3.5 Example with 3 groups

```
@startuml
nwdiag {
  group {
    color = "#FFaaaa";
    web01;
    db01;
  }
  group {
    color = "#aaFFaa";
    web02;
    db02;
  }
  group {
    color = "#aaaaFF";
    web03;
    db03;
  }

  network dmz {
    web01;
    web02;
    web03;
  }
  network internal {
    web01;
    db01 ;
    web02;
    db02 ;
    web03;
    db03;
  }
}
@enduml
```

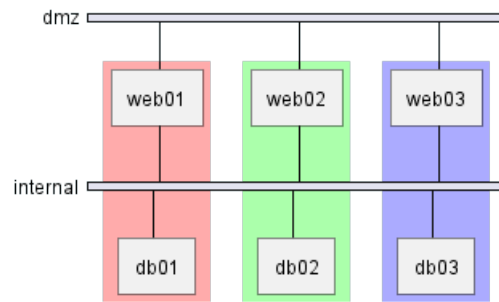

[Ref. QA-13138]

## 13.4 Extended Syntax (for network or group)

### 13.4.1 Network

For network or network's component, you can add or change:

- addresses (*separated by comma ,*);
- color;
- description;
- shape.

```
@startuml
nwdiag {
  network Sample_front {
    address = "192.168.10.0/24"
    color = "red"

    // define group
    group web {
      web01 [address = ".1, .2", shape = "node"]
      web02 [address = ".2, .3"]
    }
  }
  network Sample_back {
    address = "192.168.20.0/24"
    color = "palegreen"
    web01 [address = ".1"]
    web02 [address = ".2"]
    db01 [address = ".101", shape = database ]
    db02 [address = ".102"]

    // define network using defined nodes
    group db {
      db01;
      db02;
    }
  }
}
@enduml
```



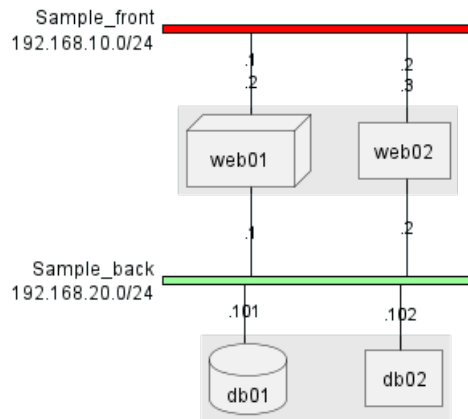

### 13.4.2 Group

For a group, you can add or change:

- color;
- description.

```
@startuml
nwdiag {
  group {
    color = "#CCFFCC";
    description = "Long group description";

    web01;
    web02;
    db01;
  }

  network dmz {
    web01;
    web02;
  }

  network internal {
    web01;
    web02;
    db01 [address = ".101", shape = database];
  }
}
@enduml
```

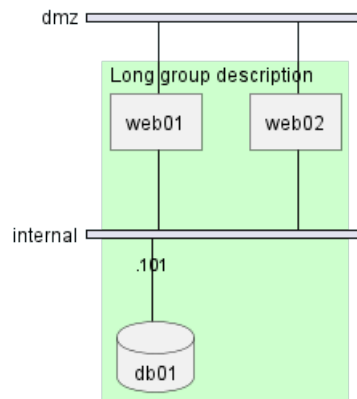

[Ref. QA-12056]

### 13.5 Using Sprites

You can use all sprites (icons) from the Standard Library or any other library.

Use the notation `<$sprite>` to use a sprite, to make a new line, or any other Creole syntax.

```
@startuml
!include <office/Servers/application_server>
!include <office/Servers/database_server>

nwdiag {
  network dmz {
    address = "210.x.x.x/24"

    // set multiple addresses (using comma)
    web01 [address = "210.x.x.1, 210.x.x.20", description = "<$application_server>\n web01"]
    web02 [address = "210.x.x.2", description = "<$application_server>\n web02"];
  }
  network internal {
    address = "172.x.x.x/24";

    web01 [address = "172.x.x.1"];
    web02 [address = "172.x.x.2"];
    db01 [address = "172.x.x.100", description = "<$database_server>\n db01"];
    db02 [address = "172.x.x.101", description = "<$database_server>\n db02"];
  }
}
@enduml
```

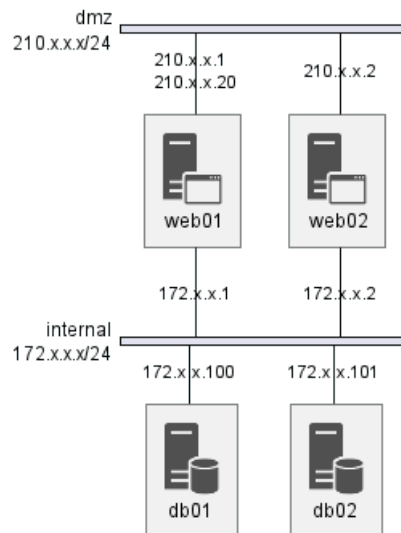

[Ref. QA-11862]

## 13.6 Using OpenIconic

You can also use the icons from OpenIconic in network or node descriptions.

Use the notation `<&icon>` to make an icon, `<&icon*n>` to multiply the size by a factor `n`, and `\n` to make a newline:

```
@startuml
nwdiag {
  group nightly {
    color = "#FFAAAA";
    description = "<&clock> Restarted nightly <&clock>";
    web02;
    db01;
  }
  network dmz {
    address = "210.x.x.x/24"

    user [description = "<&person*4.5>\n user1"];
    // set multiple addresses (using comma)
    web01 [address = "210.x.x.1, 210.x.x.20", description = "<&cog*4>\nweb01"];
    web02 [address = "210.x.x.2", description = "<&cog*4>\nweb02"];

  }
  network internal {
    address = "172.x.x.x/24";

    web01 [address = "172.x.x.1"];
    web02 [address = "172.x.x.2"];
    db01 [address = "172.x.x.100", description = "<&spreadsheet*4>\n db01"];
    db02 [address = "172.x.x.101", description = "<&spreadsheet*4>\n db02"];
    ptr [address = "172.x.x.110", description = "<&print*4>\n ptr01"];
  }
}
@enduml
```





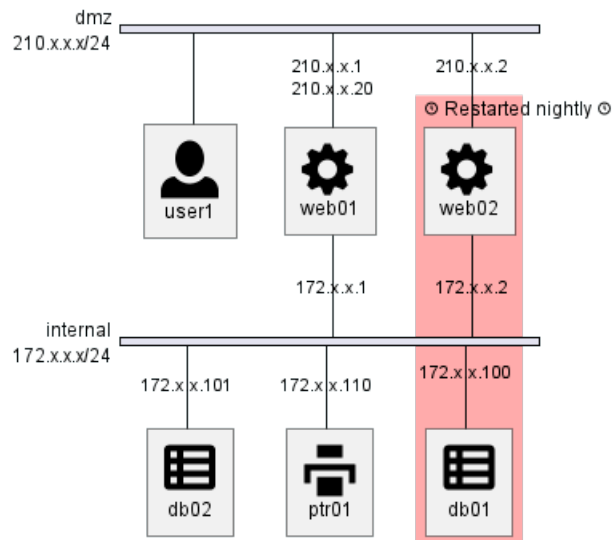

### 13.7 Same nodes on more than two networks

You can use same nodes on different networks (more than two networks); *nwdiag* use in this case 'jump line' over networks.

```
@startuml
nwdiag {
  // define group at outside network definitions
  group {
    color = "#7777FF";

    web01;
    web02;
    db01;
  }

  network dmz {
    color = "pink"

    web01;
    web02;
  }

  network internal {
    web01;
    web02;
    db01 [shape = database ];
  }

  network internal2 {
    color = "LightBlue";

    web01;
    web02;
    db01;
  }
}
}
```



```
@enduml
```

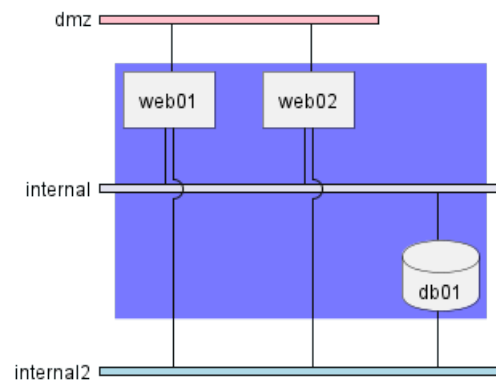

## 13.8 Peer networks

Peer networks are simple connections between two nodes, for which we don't use a horizontal "busbar" network

```
@startuml
nwdiag {
  inet [shape = cloud];
  inet -- router;

  network {
    router;
    web01;
    web02;
  }
}
@enduml
```

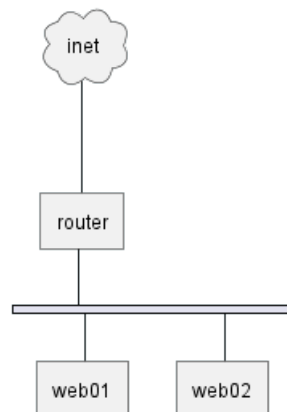

## 13.9 Peer networks and group

### 13.9.1 Without group

```
@startuml
nwdiag {
  internet [ shape = cloud];
```



```

internet -- router;

network proxy {
    router;
    app;
}
network default {
    app;
    db;
}
}
@enduml

```

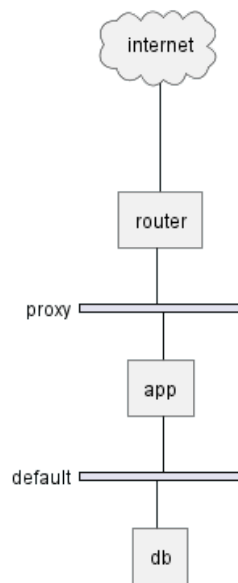

### 13.9.2 Group on first

```

@startuml
nwdiag {
    internet [ shape = cloud];
    internet -- router;

    group {
        color = "pink";
        app;
        db;
    }

    network proxy {
        router;
        app;
    }

    network default {
        app;
        db;
    }
}

```



```
@enduml
```

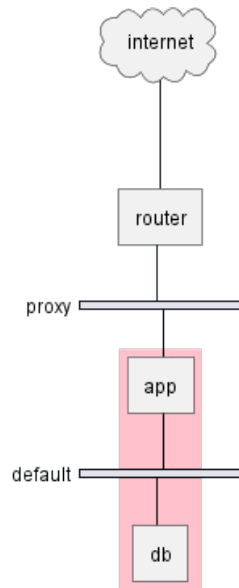

### 13.9.3 Group on second

```

@startuml
nwdiag {
    internet [ shape = cloud];
    internet -- router;

    network proxy {
        router;
        app;
    }

    group {
        color = "pink";
        app;
        db;
    }

    network default {
        app;
        db;
    }
}
@enduml

```

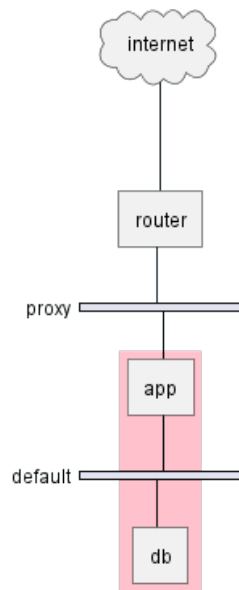

#### 13.9.4 Group on third

```

@startuml
nwdiag {
  internet [ shape = cloud];
  internet -- router;

  network proxy {
    router;
    app;
  }
  network default {
    app;
    db;
  }
  group {
    color = "pink";
    app;
    db;
  }
}
@enduml
  
```

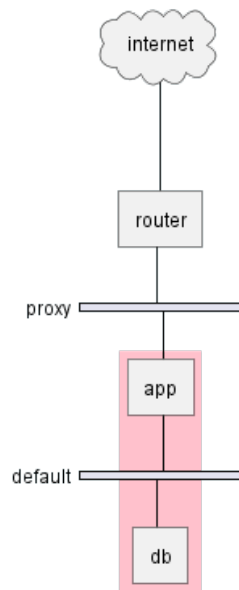

[Ref. Issue#408 and QA-12655]

### 13.10 Add title, caption, header, footer or legend on network diagram

```

@startuml
header some header
footer some footer
title My title
nwdiag {
  network inet {
    web01 [shape = cloud]
  }
}
legend
The legend
end legend
caption This is caption
@enduml

```

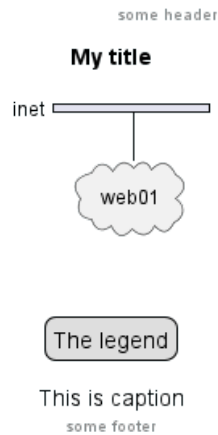

[Ref. QA-11303 and Common commands]

## 13.11 With or without shadow

### 13.11.1 With shadow (by default)

```
@startuml
nwdiag {
  network nw {
    server;
    internet;
  }
  internet [shape = cloud];
}
@enduml
```

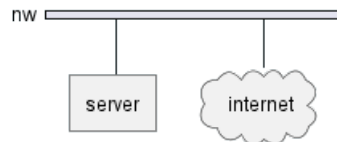

### 13.11.2 Without shadow

```
@startuml
<style>
root {
  shadowing 0
}
</style>
nwdiag {
  network nw {
    server;
    internet;
  }
  internet [shape = cloud];
}
@enduml
```



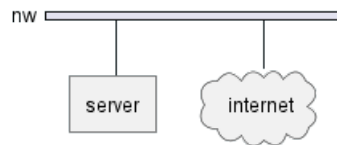

[Ref. QA-14516]

## 13.12 Change width of the networks

You can change the width of the networks, especially in order to have the same full width for only some or all networks.

Here are some examples, with all the possibilities:

- without

```
@startuml
nwdiag {
  network NETWORK_BASE {
    dev_A [address = "dev_A" ]
    dev_B [address = "dev_B" ]
  }
  network IntNET1 {
    dev_B [address = "dev_B1" ]
    dev_M [address = "dev_M1" ]
  }
  network IntNET2 {
    dev_B [address = "dev_B2" ]
    dev_M [address = "dev_M2" ]
  }
}
@enduml
```

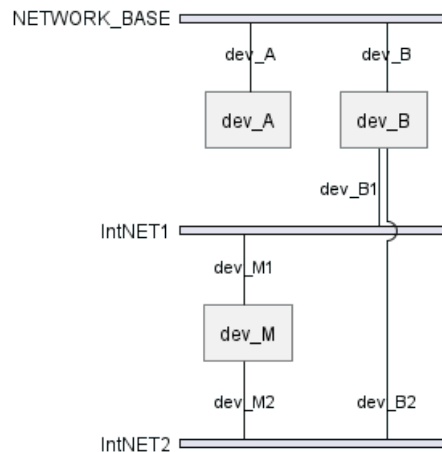

- only the first

```
@startuml
nwdiag {
  network NETWORK_BASE {
    width = full
    dev_A [address = "dev_A" ]
    dev_B [address = "dev_B" ]
  }
}
```





```

}
network IntNET1 {
  dev_B [address = "dev_B1" ]
  dev_M [address = "dev_M1" ]
}
network IntNET2 {
  dev_B [address = "dev_B2" ]
  dev_M [address = "dev_M2" ]
}
}
}
@enduml

```

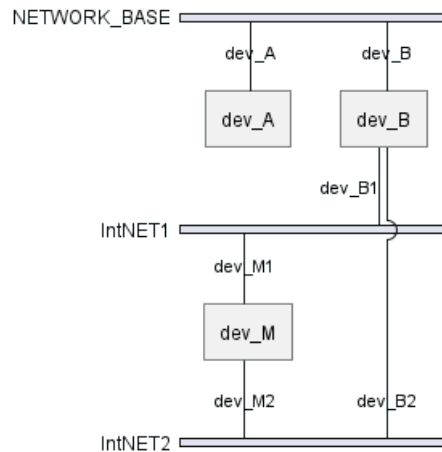

- the first and the second

```

@startuml
nwdiag {
  network NETWORK_BASE {
    width = full
    dev_A [address = "dev_A" ]
    dev_B [address = "dev_B" ]
  }
  network IntNET1 {
    width = full
    dev_B [address = "dev_B1" ]
    dev_M [address = "dev_M1" ]
  }
  network IntNET2 {
    dev_B [address = "dev_B2" ]
    dev_M [address = "dev_M2" ]
  }
}
}
@enduml

```

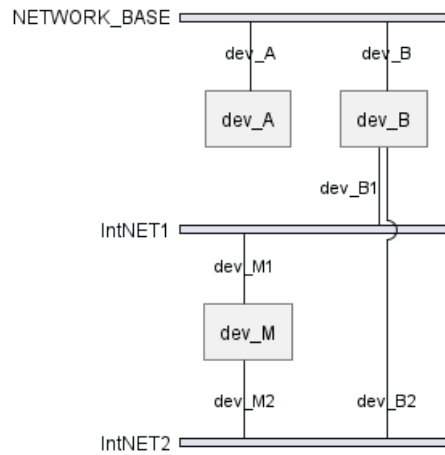

- all the network (with same full width)

```

@startuml
nwdiag {
  network NETWORK_BASE {
    width = full
    dev_A [address = "dev_A" ]
    dev_B [address = "dev_B" ]
  }
  network IntNET1 {
    width = full
    dev_B [address = "dev_B1" ]
    dev_M [address = "dev_M1" ]
  }
  network IntNET2 {
    width = full
    dev_B [address = "dev_B2" ]
    dev_M [address = "dev_M2" ]
  }
}
}
@enduml

```

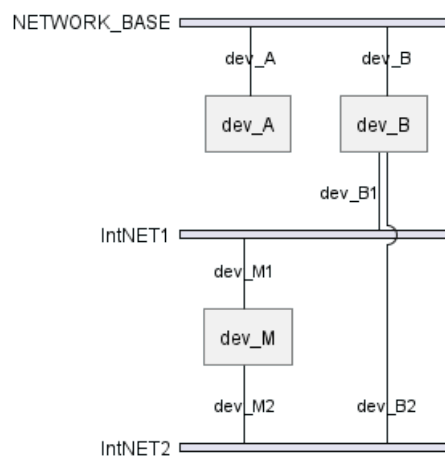

### 13.13 Other internal networks

You can define other internal networks (TCP/IP, USB, SERIAL,...).

- Without address or type

```
@startuml
nwdiag {
  network LAN1 {
    a [address = "a1"];
  }
  network LAN2 {
    a [address = "a2"];
    switch;
  }
  switch -- equip;
  equip -- printer;
}
@enduml
```

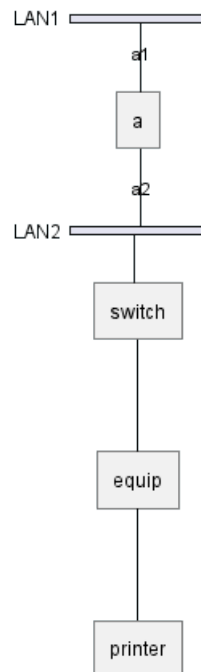

- With address or type

```
@startuml
nwdiag {
  network LAN1 {
    a [address = "a1"];
  }
  network LAN2 {
    a [address = "a2"];
    switch [address = "s2"];
  }
  switch -- equip;
  equip [address = "e3"];
  equip -- printer;
  printer [address = "USB"];
}
@enduml
```



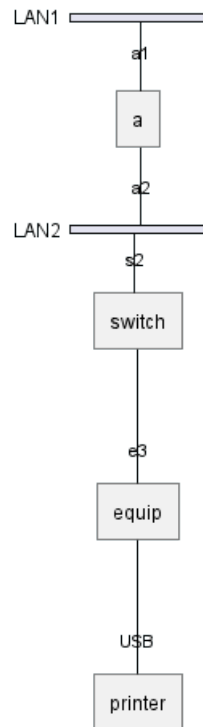

[Ref. QA-12824]

## 13.14 Using (global) style

### 13.14.1 Without style (by default)

```

@startuml
nwdiag {
  network DMZ {
    address = "y.x.x.x/24"
    web01 [address = "y.x.x.1"];
    web02 [address = "y.x.x.2"];
  }

  network Internal {
    web01;
    web02;
    db01 [address = "w.w.w.z", shape = database];
  }

  group {
    description = "long group label";
    web01;
    web02;
    db01;
  }
}
@enduml

```

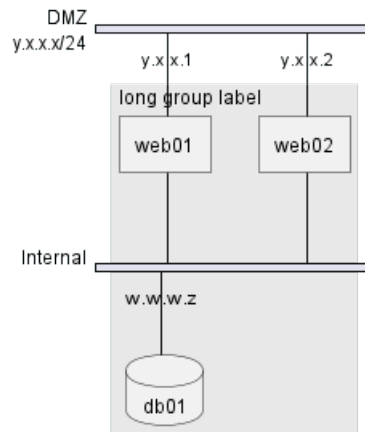

### 13.14.2 With style

You can use style to change rendering of elements.

```
@startuml
<style>
nwdiagDiagram {
  network {
    BackGroundColor green
    LineColor red
    LineThickness 1.0
    FontSize 18
    FontColor navy
  }
  server {
    BackGroundColor pink
    LineColor yellow
    LineThickness 1.0
    ' FontXXX only for description or label
    FontSize 18
    FontColor #blue
  }
  arrow {
    ' FontXXX only for address
    FontSize 17
    FontColor #red
    FontName Monospaced
    LineColor black
  }
  group {
    BackGroundColor cadetblue
    LineColor black
    LineThickness 2.0
    FontSize 11
    FontStyle bold
    Margin 5
    Padding 5
  }
}
</style>
nwdiag {
```



```

network DMZ {
    address = "y.x.x.x/24"
    web01 [address = "y.x.x.1"];
    web02 [address = "y.x.x.2"];
}

network Internal {
    web01;
    web02;
    db01 [address = "w.w.w.z", shape = database];
}

group {
    description = "long group label";
    web01;
    web02;
    db01;
}
}
@enduml

```

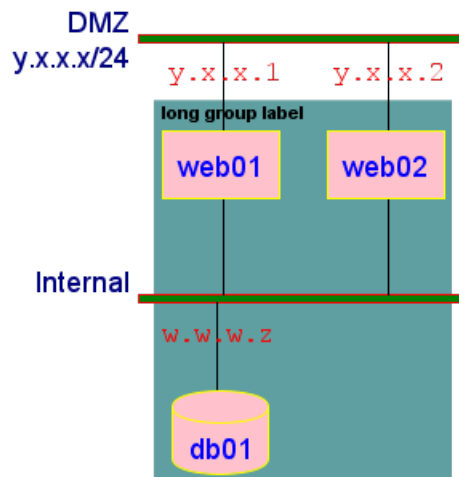

[Ref. QA-14479]

### 13.15 Appendix: Test of all shapes on Network diagram (nwdiag)

```

@startuml
nwdiag {
    network Network {
        Actor      [shape = actor]
        Agent      [shape = agent]
        Artifact   [shape = artifact]
        Boundary   [shape = boundary]
        Card       [shape = card]
        Cloud      [shape = cloud]
        Collections [shape = collections]
        Component  [shape = component]
    }
}
@enduml

```



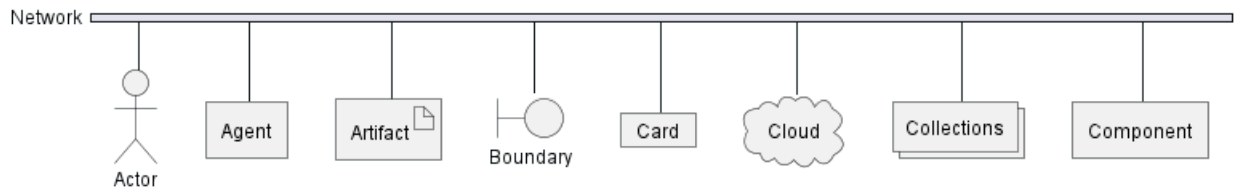

```
@startuml
nwdiag {
  network Network {
    Control      [shape = control]
    Database     [shape = database]
    Entity       [shape = entity]
    File         [shape = file]
    Folder       [shape = folder]
    Frame        [shape = frame]
    Hexagon      [shape = hexagon]
    Interface    [shape = interface]
  }
}
@enduml
```

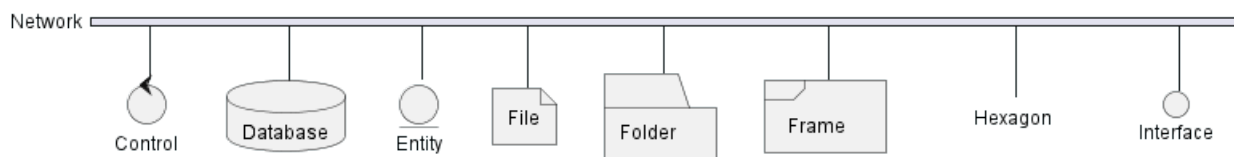

```
@startuml
nwdiag {
  network Network {
    Label        [shape = label]
    Node         [shape = node]
    Package      [shape = package]
    Person       [shape = person]
    Queue        [shape = queue]
    Stack        [shape = stack]
    Rectangle    [shape = rectangle]
    Storage      [shape = storage]
    Usecase     [shape = usecase]
  }
}
@enduml
```

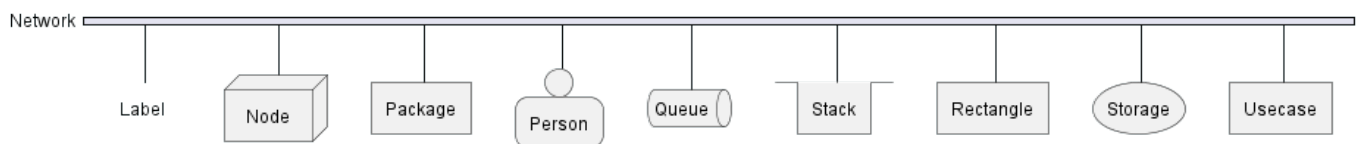

**TODO:** FIXME olli level 0 Overlap of label for folder olli olli level 0 Hexagon shape is missing olli ol



```
@startuml
nwdiag {
network Network {
Folder [shape = folder]
Hexagon [shape = hexagon]
}
}
@enduml
```

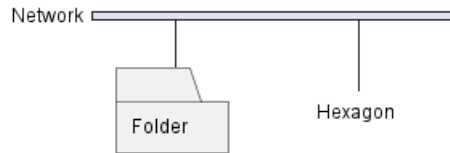

```
@startuml
nwdiag {
network Network {
Folder [shape = folder, description = "Test, long long label\nTest, long long label"]
Hexagon [shape = hexagon, description = "Test, long long label\nTest, long long label"]
}
}
@enduml
```

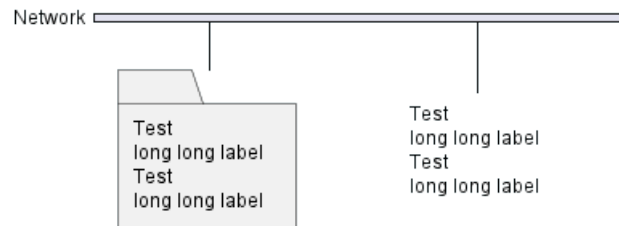

TODO: FIXME



## 14 Salt (Wireframe)

**Salt** is a subproject included in PlantUML that may help you to design graphical interface or *Website Wireframe* or *Page Schematic* or *Screen Blueprint*.

The goal of this tool is to discuss about simple and sample windows.

You can use either `@startsalt` keyword, or `@startuml` followed by a line with `salt` keyword.

### 14.1 Basic widgets

A window must start and end with brackets. You can then define:

- Button using `[` and `]`.
- Radio button using `(` and `)`.
- Checkbox using `[` and `]`.
- User text area using `"`.
- Droplist using `^`.

```
@startsalt
{
  Just plain text
  [This is my button]
  () Unchecked radio
  (X) Checked radio
  [] Unchecked box
  [X] Checked box
  "Enter text here  "
  ^This is a droplist^
}
@endsalt
```

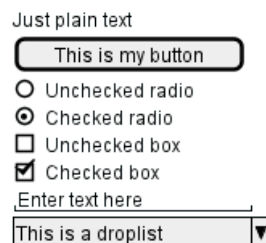

### 14.2 Text area

Here is an attempt to create a text area:

```
@startsalt
{+
  This is a long
  text in a textarea
  :
  "
}
@endsalt
```



Note:



- the dot (.) to fill up vertical space;
- the last line of space (" ") to make the area wider.

[Ref. QA-14765]

Then you can add scroll bar:

```
@startsalt
{SI
  This is a long
  text in a textarea
  .
  "
}
@endsalt
```



```
@startsalt
{S-
  This is a long
  text in a textarea
  .
  "
}
@endsalt
```

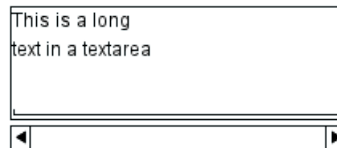

### 14.3 Open, close droplist

You can open a droplist, by adding values enclosed by ^, as:

```
@startsalt
{
  ^This is a closed droplist^ |
  ^This is an open droplist^^ item 1^^ item 2^ |
  ^This is another open droplist^ item 1^ item 2^
}
@endsalt
```

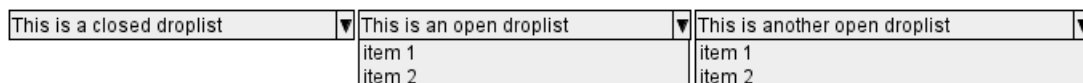

[Ref. QA-4184]

### 14.4 Using grid [| and #, !, -, +]

A table is automatically created when you use an opening bracket {. And you have to use | to separate columns.

For example:

```
@startsalt
{
```

```

Login    | "MyName  "
Password | "****   "
[Cancel] | [ OK   ]
}
@endsalt

```

Just after the opening bracket, you can use a character to define if you want to draw lines or columns of the grid :

Symbol	Result
#	To display all vertical and horizontal lines
!	To display all vertical lines
-	To display all horizontal lines
+	To display external lines

```

@startsalt
{+
  Login    | "MyName  "
  Password | "****   "
  [Cancel] | [ OK   ]
}
@endsalt

```

## 14.5 Group box [^]

```

@startsalt
{^"My group box"
  Login    | "MyName  "
  Password | "****   "
  [Cancel] | [ OK   ]
}
@endsalt

```

[Ref. QA-5840]

## 14.6 Using separator [..., ==, ~~, -]

You can use several horizontal lines as separator.

```

@startsalt
{
  Text1
  ..
  "Some field"
  ==
  Note on usage
  ~~
}

```



```

Another text
--
[Ok]
}
@endsalt

```

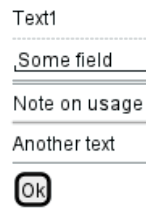

## 14.7 Tree widget [T]

To have a Tree, you have to start with {T and to use + to denote hierarchy.

```

@startsalt
{
{T
+ World
++ America
+++ Canada
+++ USA
++++ New York
++++ Boston
+++ Mexico
++ Europe
+++ Italy
+++ Germany
++++ Berlin
++ Africa
}
}
@endsalt

```



## 14.8 Tree table [T]

You can combine trees with tables.

```

@startsalt
{
{T
+Region      | Population   | Age
+ World      | 7.13 billion | 30
++ America   | 964 million  | 30
+++ Canada   | 35 million   | 30
+++ USA      | 319 million  | 30
++++ NYC     | 8 million    | 30
}
}
@endsalt

```



```

++++ Boston      | 617 thousand | 30
+++ Mexico       | 117 million  | 30
++ Europe        | 601 million  | 30
+++ Italy        | 61 million   | 30
+++ Germany      | 82 million   | 30
++++ Berlin     | 3 million    | 30
++ Africa        | 1 billion    | 30
}
}
@endsalt

```

Region	Population	Age
World	7.13 billion	30
America	964 million	30
Canada	35 million	30
USA	319 million	30
NYC	8 million	30
Boston	617 thousand	30
Mexico	117 million	30
Europe	601 million	30
Italy	61 million	30
Germany	82 million	30
Berlin	3 million	30
Africa	1 billion	30

And add lines.

```

@startsalt
{
..
== with T!
{T!
+Region      | Population  | Age
+ World      | 7.13 billion | 30
++ America   | 964 million  | 30
}
..
== with T-
{T-
+Region      | Population  | Age
+ World      | 7.13 billion | 30
++ America   | 964 million  | 30
}
..
== with T+
{T+
+Region      | Population  | Age
+ World      | 7.13 billion | 30
++ America   | 964 million  | 30
}
..
== with T#
{T#
+Region      | Population  | Age
+ World      | 7.13 billion | 30
++ America   | 964 million  | 30
}
..
}
@endsalt

```



with T!		
Region	Population	Age
World	7.13 billion	30
America	964 million	30

with T-		
Region	Population	Age
World	7.13 billion	30
America	964 million	30

with T+		
Region	Population	Age
World	7.13 billion	30
America	964 million	30

with T#		
Region	Population	Age
World	7.13 billion	30
America	964 million	30

[Ref. QA-1265]

## 14.9 Enclosing brackets [{, }]

You can define subelements by opening a new opening bracket.

```
@startsalt
{
Name           | "           "
Modifiers:     | { (X) public | () default | () private | () protected
               | [] abstract | [] final   | [] static }
Superclass:   | { "java.lang.Object " | [Browse...] }
}
@endsalt
```

Name

Modifiers:  public  default  private  protected  
 abstract  final  static

Superclass:

## 14.10 Adding tabs [/]

You can add tabs using {/ notation. Note that you can use HTML code to have bold text.

```
@startsalt
{+
{/ <b>General | Fullscreen | Behavior | Saving }
{
{ Open image in: | ^Smart Mode^ }
[X] Smooth images when zoomed
[X] Confirm image deletion
[ ] Show hidden images
}
[Close]
}
@endsalt
```

General  Fullscreen  Behavior  Saving

Open image in:

Smooth images when zoomed  
 Confirm image deletion  
 Show hidden images



Tab could also be vertically oriented:

```
@startsalt
{+
{/ <b>General
Fullscreen
Behavior
Saving } |
{
{ Open image in: | ^Smart Mode^ }
[X] Smooth images when zoomed
[X] Confirm image deletion
[ ] Show hidden images
[Close]
}
}
@endsalt
```

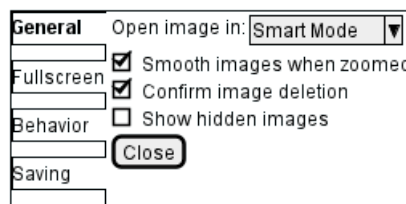

## 14.11 Using menu [\*]

You can add a menu by using {\* notation.

```
@startsalt
{+
{* File | Edit | Source | Refactor }
{/ General | Fullscreen | Behavior | Saving }
{
{ Open image in: | ^Smart Mode^ }
[X] Smooth images when zoomed
[X] Confirm image deletion
[ ] Show hidden images
}
[Close]
}
@endsalt
```

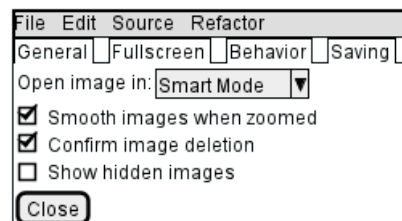

It is also possible to open a menu:

```
@startsalt
{+
{* File | Edit | Source | Refactor
  Refactor | New | Open File | - | Close | Close All }
{/ General | Fullscreen | Behavior | Saving }
{
{ Open image in: | ^Smart Mode^ }
}
```



```

[X] Smooth images when zoomed
[X] Confirm image deletion
[ ] Show hidden images
}
[Close]
}
@endsalt

```

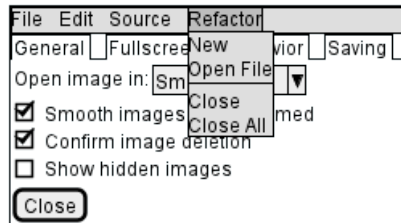

Like it is possible to open a droplist:

```

@startsalt
{+
{* File | Edit | Source | Refactor }
{/ General | Fullscreen | Behavior | Saving }
{
{ Open image in: | ^Smart Mode^^Normal Mode^ }
[X] Smooth images when zoomed
[X] Confirm image deletion
[ ] Show hidden images
}
[Close]
}
@endsalt

```

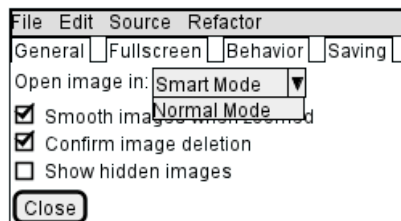

[Ref. QA-4184]

## 14.12 Advanced table

You can use two special notations for table :

- \* to indicate that a cell with span with left
- . to denote an empty cell

```

@startsalt
{#
. | Column 2 | Column 3
Row header 1 | value 1 | value 2
Row header 2 | A long cell | *
}
@endsalt

```

	Column 2	Column 3
Row header 1	value 1	value 2
Row header 2	A long cell	





### 14.13 Scroll Bars [S, SI, S-]

You can use {S notation for scroll bar like in following examples:

- {S: for horizontal and vertical scrollbars

```
@startsalt
{S
Message
.
.
.
.
}
@endsalt
```



- {SI : for vertical scrollbar only

```
@startsalt
{SI
Message
.
.
.
.
}
@endsalt
```



- {S- : for horizontal scrollbar only

```
@startsalt
{S-
Message
.
.
.
.
}
@endsalt
```



### 14.14 Colors

It is possible to change text color of widget.



```

@startsalt
{
  <color:Blue>Just plain text
  [This is my default button]
  [<color:green>This is my green button]
  [<color:#9a9a9a>This is my disabled button]
  [] <color:red>Unchecked box
  [X] <color:green>Checked box
  "Enter text here  "
  ^This is a droplist^
  ^<color:#9a9a9a>This is a disabled droplist^
  ^<color:red>This is a red droplist^
}
@endsalt

```

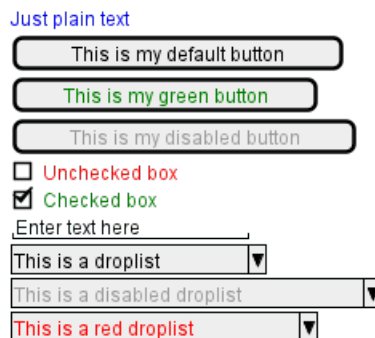

[Ref. QA-12177]

## 14.15 Creole on Salt

You can use Creole or HTML Creole on salt:

```

@startsalt
{{^==Creole
  This is bold
  This is italics
  This is "monospaced"
  This is stricken-out
  This is underlined
  This is wave-underlined
  --test Unicode and icons--
  This is <U+221E> long
  This is a <&code> icon
  Use image : <img:http://plantuml.com/logo3.png>
}]
{^<b>HTML Creole
  This is <b>bold</b>
  This is <i>italics</i>
  This is <font:monospaced>monospaced</font>
  This is <s>stroked</s>
  This is <u>underlined</u>
  This is <w>waved</w>
  This is <s:green>stroked</s>
  This is <u:red>underlined</u>
  This is <w:#0000FF>waved</w>
  -- other examples --
  This is <color:blue>Blue</color>
  This is <back:orange>Orange background</back>
  This is <size:20>big</size>

```



```

}|
{^Creole line
You can have horizontal line
----
Or double line
=====
Or strong line
----
Or dotted line
..My title..
Or dotted title
//and title... //
==Title==
Or double-line title
--Another title--
Or single-line title
Enjoy!
}|
{^Creole list item
**test list 1**
* Bullet list
* Second item
** Sub item
*** Sub sub item
* Third item
----
**test list 2**
# Numbered list
# Second item
## Sub item
## Another sub item
# Third item
}|
{^Mix on salt
  ==<color:Blue>Just plain text
  [This is my default button]
  [<b><color:green>This is my green button]
  [ ---<color:#9a9a9a>This is my disabled button-- ]
  [] <size:20><color:red>Unchecked box
  [X] <color:green>Checked box
  "//Enter text here//  "
  ^This is a droplist^
  ^<color:#9a9a9a>This is a disabled droplist^
  ^<b><color:red>This is a red droplist^
}}
@endsalt

```

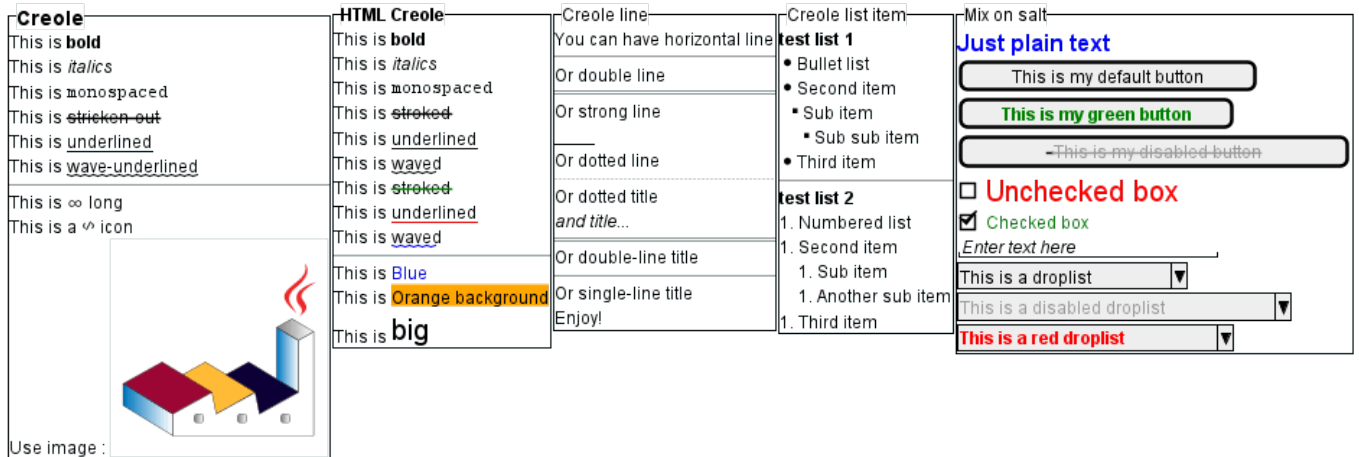

### 14.16 Pseudo sprite [«, »]

Using << and >> you can define a pseudo-sprite or sprite-like drawing and reusing it latter.

```
@startsalt
{
[X] checkbox|[] checkbox
() radio | (X) radio
This is a text|[This is my button]|This is another text
"A field"|"Another long Field"|A button
<<folder
.....
.XXXXX.....
.X...X.....
.XXXXXXXXXX.
.X.....X.
.X.....X.
.X.....X.
.X.....X.
.X.....X.
.XXXXXXXX.
.....
>>|<color:blue>other folder|<<folder>>
^Droplist^
}
@endsalt
```

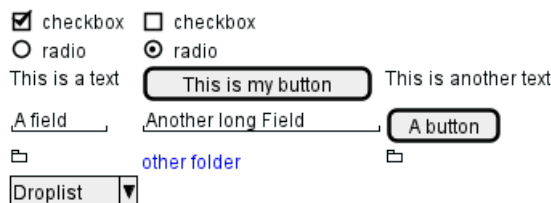

[Ref. QA-5849]

### 14.17 OpenIconic

OpenIconic is a very nice open source icon set. Those icons have been integrated into the creole parser, so you can use them out-of-the-box. You can use the following syntax: <&ICON\_NAME>.

```
@startsalt
{
Login<&person> | "MyName "
Password<&key> | "**** "
```

```
[Cancel <&circle-x>] | [OK <&account-login>]
}
@endsalt
```



The complete list is available on OpenIconic Website, or you can use the following special diagram:

```
@startuml
listopeniconic
@enduml
```

List Open Iconic	▲ bell	☁ cloud	≡ excerpt	≡ justify-right	🎵 musical-note	★ star
<i>Credit to</i> <a href="https://useiconic.com/open">https://useiconic.com/open</a>	📶 bluetooth	☁️ cloudy	⏏ expand-down	🗝 key	📄 paperclip	☀ sun
	🔩 bolt	📄 code	⏏ expand-left	💻 laptop	✍ pencil	📱 tablet
➡ account-login	📖 book	⚙ cog	⏏ expand-right	📂 layers	👤 person	🏷 tag
➡ account-logout	🔖 bookmark	⏏ collapse-down	⏏ expand-up	💡 lightbulb	👤 person	🏷 tags
↶ action-redo	📦 box	⏏ collapse-left	🔗 external-link	🔗 link-broken	📱 phone	🎯 target
↷ action-undo	📁 briefcase	⏏ collapse-right	👁 eye	🔗 link-intact	📊 pie-chart	🗑 trash
≡ align-center	📄 browser	⏏ collapse-up	👁 eyedropper	📋 list-rich	📌 pin	🖨 terminal
≡ align-left	🔧 brush	⚡ command	📁 file	📋 list	🎮 play-circle	⌨ text
≡ align-right	🐛 bug	📄 comment-square	🔥 fire	📍 location	➕ plus	👇 thumb-down
🔍 aperture	📣 bullhorn	📄 compass	🚩 flag	🔒 lock-locked	🔌 power-standby	👍 thumb-up
↓ arrow-bottom	📊 calculator	📄 copywriting	⚡ flash	🔓 lock-unlocked	🖨 print	⌚ timer
🕒 arrow-circle-bottom	📅 calendar	📄 credit-card	📁 folder	🔄 loop-circular	📁 project	➡ transfer
🕒 arrow-circle-left	📷 camera-slr	✂ crop	🔗 fork	📱 loop-square	📌 puzzle-piece	🗑 trash
🕒 arrow-circle-right	⏏ caret-bottom	📄 dashboard	🖥 fullscreen-enter	📱 loop	❓ question-mark	📂 underline
↶ arrow-circle-top	⏏ caret-left	⬇ data-transfer-download	🌐 globe	🔍 magnifying-glass	🌧 rain	≡ vertical-align-bottom
↶ arrow-left	⏏ caret-right	⬆ data-transfer-upload	📊 graph	📍 map-marker	🎲 random	≡ vertical-align-center
➡ arrow-right	⏏ caret-top	🗑 delete	📊 grid-four-up	📍 map	🔄 reload	≡ vertical-align-top
⬇ arrow-thick-bottom	⏏ chat	📄 document	📊 grid-three-up	⏏ media-pause	🔄 resize-both	📹 video
↶ arrow-thick-left	✓ check	💰 dollar	📊 grid-two-up	▶ media-play	↕ resize-height	🔊 volume-high
➡ arrow-thick-right	↶ chevron-bottom	” double-quote-sans-left	📄 hard-drive	⏏ media-record	↔ resize-width	🔊 volume-low
↑ arrow-thick-top	↶ chevron-left	“ double-quote-sans-right	📄 header	⏏ media-skip-backward	📡 rss-alt	🔊 volume-off
↑ arrow-top	↶ chevron-right	” double-quote-serif-left	🎧 headphones	▶ media-skip-forward	📡 rss	⚠ warning
🔊 audio-spectrum	➡ chevron-top	” double-quote-serif-right	♥ heart	▶ media-step-backward	📜 script	📶 wifi
🔊 audio	⏏ chevron-bottom	📄 cart	🏠 home	▶ media-step-forward	📄 share-boxed	🔧 wrench
📌 badge	⏏ chevron-left	📄 chat	📄 image	⏏ media-stop	➡ share	✖ x
🚫 ban	⏏ chevron-right	📄 check	📄 inbox	🏥 medical-cross	🛡 shield	👤 yen
📊 bar-chart	⏏ chevron-top	📄 circle-check	∞ infinity	📱 menu	📶 signal	🔍 zoom-in
🛒 basket	⏏ circle-x	📄 clipboard	📄 info	📱 microphone	📶 signpost	🔍 zoom-out
🔋 battery-empty	🕒 clock	📄 clock	📄 italic	📱 minus	↕ sort-ascending	
🔋 battery-full	☁ cloud-download	📄 cloud	≡ justify-center	🌙 moon	↕ sort-descending	
🧴 beaker	☁ cloud-upload	€ euro	≡ justify-left	➕ move	📊 spreadsheet	

## 14.18 Add title, header, footer, caption or legend

```
@startsalt
title My title
header some header
footer some footer
caption This is caption
legend
The legend
end legend
```

```
{+
  Login | "MyName"
  Password | "****"
  [Cancel] | [ OK ]
}
```

```
@endsalt
```





(See also: *Common commands*)

## 14.19 Zoom, DPI

### 14.19.1 Whitout zoom (by default)

```
@startsalt
{
  <&person> Login | "MyName  "
  <&key> Password | "****  "
  [<&circle-x> Cancel ] | [ <&account-login> OK  ]
}
@endsalt
```



### 14.19.2 Scale

You can use the `scale` command to zoom the generated image.

You can use either a number or a fraction to define the scale factor. You can also specify either width or height (in pixel). And you can also give both width and height: the image is scaled to fit inside the specified dimension.

```
@startsalt
scale 2
{
  <&person> Login | "MyName  "
  <&key> Password | "****  "
  [<&circle-x> Cancel ] | [ <&account-login> OK  ]
}
@endsalt
```



(See also: *Zoom on Common commands*)

### 14.19.3 DPI

You can also use the `skinparam dpicommand` to zoom the generated image.

```
@startsalt
```

```

skinparam dpi 200
{
  <&person> Login | "MyName  "
  <&key> Password | "****  "
  [<&circle-x> Cancel ] | [ <&account-login> OK  ]
}
@endsalt

```



## 14.20 Include Salt "on activity diagram"

You can read the following explanation.

```

@startuml
(*) --> "
{{
salt
{+
<b>an example
choose one option
()one
()two
[ok]
}
}}
" as choose

choose -right-> "
{{
salt
{+
<b>please wait
operation in progress
<&clock>
[cancel]
}
}}
" as wait
wait -right-> "
{{
salt
{+
<b>success
congratulations!
[ok]
}
}}
" as success

wait -down-> "
{{
salt

```



```

{+
<b>error
failed, sorry
[ok]
}
}}
"
@enduml

```

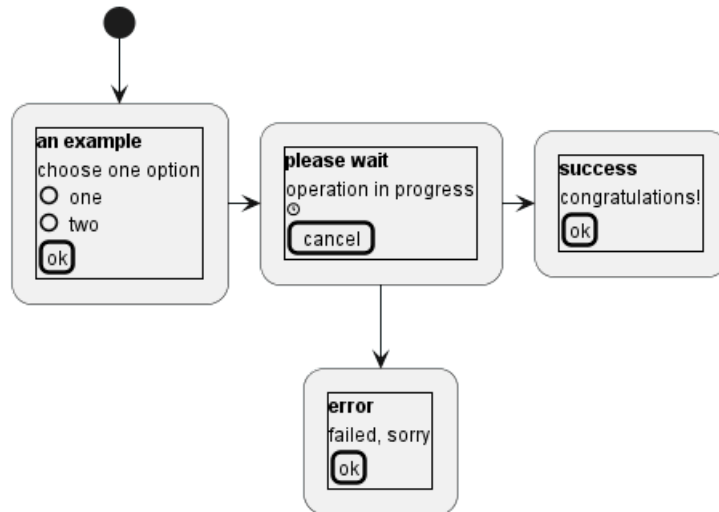

It can also be combined with define macro.

```

@startuml
!unquoted procedure SALT($x)
"{{
salt
%invoke_procedure("_"+"$x)
}}" as $x
!endprocedure

!procedure _choose()
{+
<b>an example
choose one option
()one
()two
[ok]
}
!endprocedure

!procedure _wait()
{+
<b>please wait
operation in progress
<&clock>
[cancel]
}
!endprocedure

!procedure _success()
{+
<b>success
congratulations!

```



```

[ok]
}
!endprocedure

!procedure _error()
{+
<b>error
failed, sorry
[ok]
}
!endprocedure

(*) --> SALT(choose)
-right-> SALT(wait)
wait -right-> SALT(success)
wait -down-> SALT(error)
@enduml

```

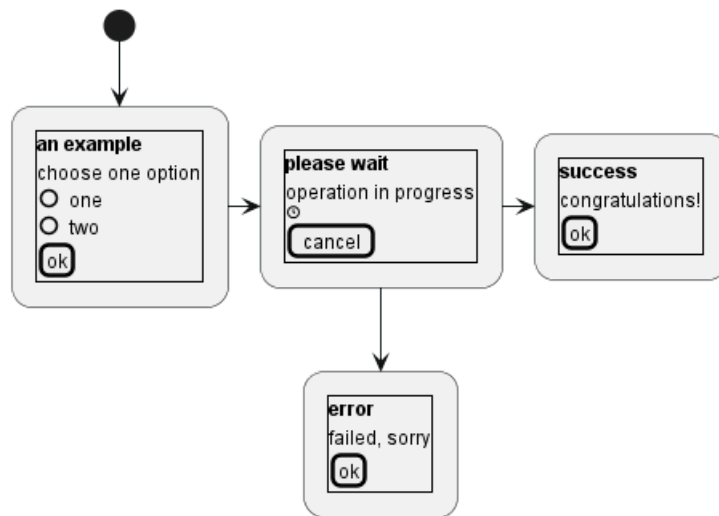

## 14.21 Include salt "on while condition of activity diagram"

You can include salt on while condition of activity diagram.

```

@startuml
start
while (\n{\nsalt\n{+\nPassword | "****      "\n[Cancel] | [ OK  ]}\n}) is (Incorrect)
  :log attempt;
  :attempt_count++;
  if (attempt_count > 4) then (yes)
    :increase delay timer;
    :wait for timer to expire;
  else (no)
  endif
endwhile (correct)
:log request;
:disable service;
@enduml

```

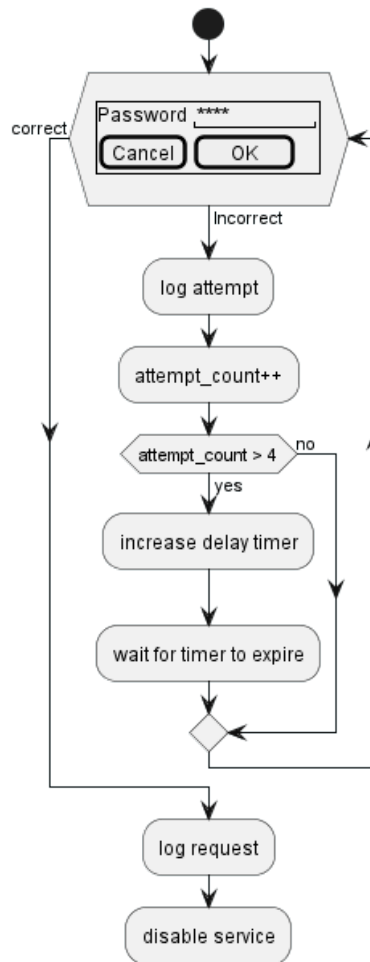

[Ref. QA-8547]

## 14.22 Include salt "on repeat while condition of activity diagram"

You can include salt on 'repeat while' condition of activity diagram.

```

@startuml
start
repeat :read data;
  :generate diagrams;
repeat while (\n{\nsalt\n{"Next step"\n Do you want to continue? \n[Yes] | [No]\n}\n})\n
stop
@enduml
  
```

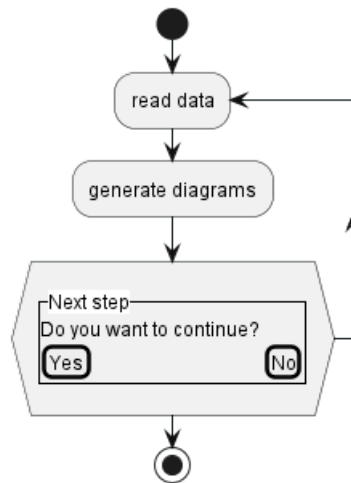

[Ref. QA-14287]

### 14.23 Skinparam

You can use [only] some skinparam command to change the skin of the drawing.

Some example:

```

@startsalt
skinparam Backgroundcolor palegreen
{+
  Login    | "MyName  "
  Password | "****    "
  [Cancel] | [ OK   ]
}
@endsalt
  
```

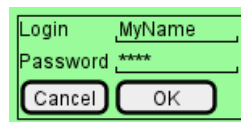

```

@startsalt
skinparam handwritten true
{+
  Login    | "MyName  "
  Password | "****    "
  [Cancel] | [ OK   ]
}
@endsalt
  
```



**TODO: FIXME** FYI, some other skinparam does not work with salt, as:

```

@startsalt
skinparam defaultFontName monospaced
{+
  Login    | "MyName  "
  Password | "****    "
  [Cancel] | [ OK   ]
}
@endsalt
  
```



## 14.24 Style

You can use [only] some style command to change the skin of the drawing.

Some example:

```
@startsalt
<style>
saltDiagram {
  BackgroundColor palegreen
}
</style>
{+
  Login | "MyName" |
  Password | "****" |
  [Cancel] | [ OK ]
}
@endsalt
```

**TODO: FIXME** FYI, some other style does not work with salt, as:

```
@startsalt
<style>
saltDiagram {
  Fontname Monospaced
  FontSize 10
  FontStyle italic
  LineThickness 0.5
  LineColor red
}
</style>
{+
  Login | "MyName" |
  Password | "****" |
  [Cancel] | [ OK ]
}
@endsalt
```

[Ref. QA-13460]

## 15 Archimate Diagram

This is only a proposal and subject to change.

You are very welcome to create a new discussion on this future syntax. Your feedbacks, ideas and suggestions help us to find the right solution.

### 15.1 Archimate keyword

You can use the `archimate` keyword to define an element. Stereotype can optionally specify an additional icon. Some colors (Business, Application, Motivation, Strategy, Technology, Physical, Implementation) are also available.

```
@startuml
archimate #Technology "VPN Server" as vpnServerA <<technology-device>>

rectangle GO #lightgreen
rectangle STOP #red
rectangle WAIT #orange
@enduml
```

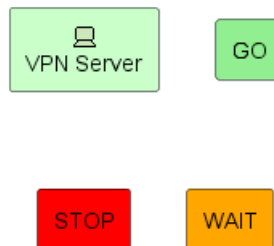

### 15.2 Defining Junctions

Using the `circle` keyword and the preprocessor, you can also create junctions.

```
@startuml
!define Junction_Or circle #black
!define Junction_And circle #whitesmoke

Junction_And JunctionAnd
Junction_Or JunctionOr

archimate #Technology "VPN Server" as vpnServerA <<technology-device>>

rectangle GO #lightgreen
rectangle STOP #red
rectangle WAIT #orange
GO -up-> JunctionOr
STOP -up-> JunctionOr
STOP -down-> JunctionAnd
WAIT -down-> JunctionAnd
@enduml
```

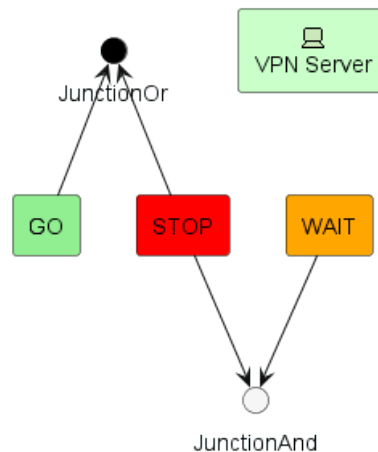

### 15.3 Example 1

```

@startuml
skinparam rectangle<<behavior>> {
  roundCorner 25
}
sprite $bProcess jar:archimate/business-process
sprite $aService jar:archimate/application-service
sprite $aComponent jar:archimate/application-component

rectangle "Handle claim" as HC <<$bProcess>><<behavior>> #Business
rectangle "Capture Information" as CI <<$bProcess>><<behavior>> #Business
rectangle "Notify\nAdditional Stakeholders" as NAS <<$bProcess>><<behavior>> #Business
rectangle "Validate" as V <<$bProcess>><<behavior>> #Business
rectangle "Investigate" as I <<$bProcess>><<behavior>> #Business
rectangle "Pay" as P <<$bProcess>><<behavior>> #Business

HC *-down- CI
HC *-down- NAS
HC *-down- V
HC *-down- I
HC *-down- P

CI -right->> NAS
NAS -right->> V
V -right->> I
I -right->> P

rectangle "Scanning" as scanning <<$aService>><<behavior>> #Application
rectangle "Customer administration" as customerAdministration <<$aService>><<behavior>> #Application
rectangle "Claims administration" as claimsAdministration <<$aService>><<behavior>> #Application
rectangle Printing <<$aService>><<behavior>> #Application
rectangle Payment <<$aService>><<behavior>> #Application

scanning -up-> CI
customerAdministration -up-> CI
claimsAdministration -up-> NAS
claimsAdministration -up-> V
claimsAdministration -up-> I
Payment -up-> P

Printing -up-> V
Printing -up-> P

```



```

rectangle "Document\nManagement\nSystem" as DMS <<$aComponent>> #Application
rectangle "General\nCRM\nSystem" as CRM <<$aComponent>> #Application
rectangle "Home & Away\nPolicy\nAdministration" as HAPA <<$aComponent>> #Application
rectangle "Home & Away\nFinancial\nAdministration" as HFPA <<$aComponent>> #Application
    
```

```

DMS .up.|> scanning
DMS .up.|> Printing
CRM .up.|> customerAdministration
HAPA .up.|> claimsAdministration
HFPA .up.|> Payment
    
```

```

legend left
Example from the "Archinsurance case study" (OpenGroup).
See
====
<$bProcess> :business process
====
<$aService> : application service
====
<$aComponent> : application component
endlegend
@enduml
    
```

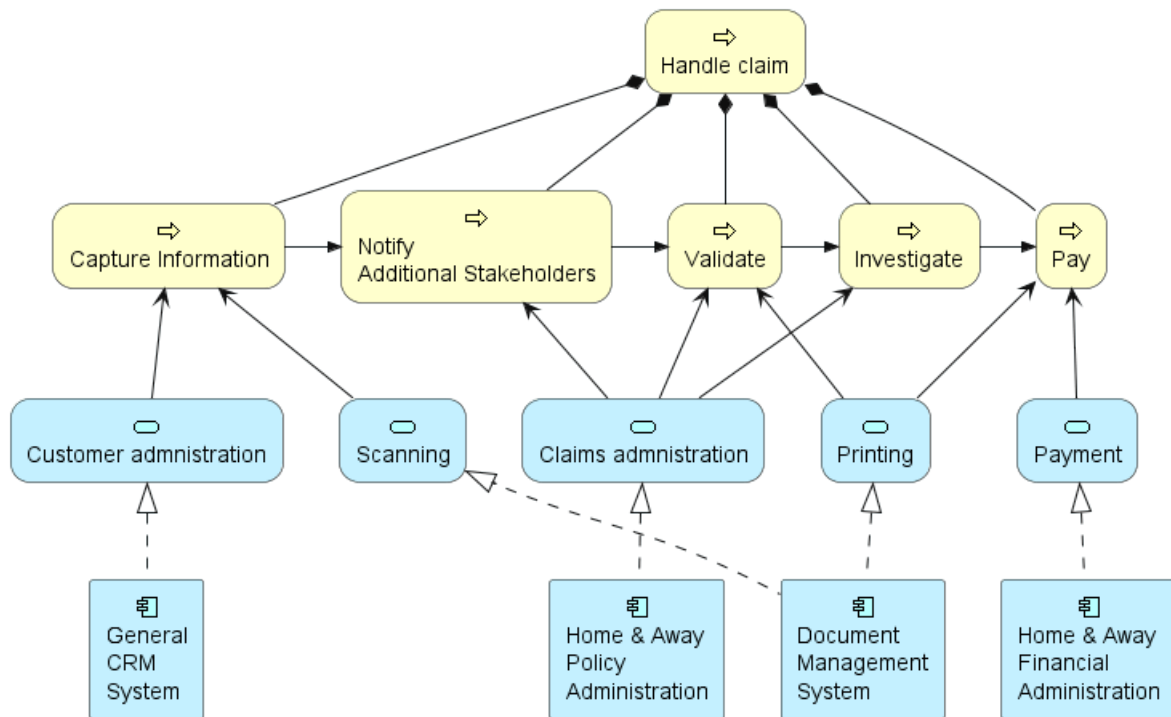

Example from the "Archinsurance case study" (OpenGroup). See
⇒ :business process
○ : application service
☐ : application component

## 15.4 Example 2

```
@startuml
```

```
skinparam roundcorner 25
rectangle "Capture Information" as CI <<$archimate/business-process>> #Business
@enduml
```

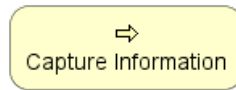

## 15.5 List possible sprites

You can list all possible sprites for Archimate using the following diagram:

```
@startuml
listsprite
@enduml
```

### List Current Sprites

Credit to  
<http://www.archimatetool.com>

archimate :

access  
activity  
actor  
aggregation  
application-collaboration  
application-component  
application-data-object  
application-event  
application-function  
application-interaction  
application-interface  
application-process  
application-service  
assessment-filled  
assessment  
assignment  
association-unidirect  
association  
business-activity  
business-actor  
business-collaboration  
business-contract  
business-event  
business-function  
business-interaction  
business-interface  
business-location  
business-meaning  
business-object  
business-process  
business-product  
business-representation  
business-role  
business-service  
business-value  
collaboration  
communication-path  
component  
composition  
constraint-filled  
constraint  
contract  
deliverable-filled  
deliverable  
device  
driver-filled  
driver  
event  
flow  
function  
gap-filled  
gap  
goal-filled  
goal  
implementation-deliverable  
implementation-event  
implementation-gap  
implementation-plateau  
implementation-workpackage  
influence  
interaction  
interface-required

interface-symmetric  
interface  
junction-and  
junction-or  
junction  
location  
meaning  
motivation-assessment  
motivation-constraint  
motivation-driver  
motivation-goal  
motivation-meaning  
motivation-outcome  
motivation-principle  
motivation-requirement  
motivation-stakeholder  
motivation-value  
network  
node  
object  
physical-distribution-network  
physical-equipment  
physical-facility  
physical-material  
plateau  
principle-filled  
principle  
process  
product  
realisation  
representation  
requirement-filled  
requirement  
role

service  
serving  
specialisation  
specialization  
stakeholder-filled  
strategy-capability  
strategy-course-of-action  
strategy-resource  
strategy-value-stream  
system-software  
technology-artifact  
technology-collaboration  
technology-communication-network  
technology-communication-path  
technology-device  
technology-event  
technology-function  
technology-infra-interface  
technology-infra-service  
technology-interaction  
technology-interface  
technology-network  
technology-node  
technology-path  
technology-process  
technology-service  
technology-system-software  
triggering  
used-by  
value  
workpackage-filled

## 15.6 ArchiMate Macros

### 15.6.1 Archimate Macros and Library

A list of Archimate macros are defined Archimate-PlantUML here which simplifies the creation of ArchiMate diagrams, and Archimate is natively on the Standard Library of PlantUML.

### 15.6.2 Archimate elements

Using the macros, creation of ArchiMate elements are done using the following format: `Category_ElementName (nameOfThe "description")`

For example:

- To define a *Stakeholder* element, which is part of Motivation category, the syntax will be `Motivation_Stakeholder (S "Stakeholder Description")`:





```
@startuml
!include <archimate/Archimate>
Motivation_Stakeholder(StakeholderElement, "Stakeholder Description")
@enduml
```



- To define a *Business Service* element, `Business_Service(BService, "Business Service")`:

```
@startuml
!include <archimate/Archimate>
Business_Service(BService, "Business Service")
@enduml
```

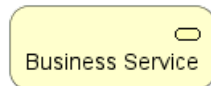

### 15.6.3 Archimate relationships

The ArchiMate relationships are defined with the following pattern: `Rel_RelationType(fromElement, toElement, "description")` and to define the direction/orientation of the two elements: `Rel_RelationType_Direction toElement, "description")`

The `RelationTypes` supported are:

- Access
- Aggregation
- Assignment
- Association
- Composition
- Flow
- Influence
- Realization
- Serving
- Specialization
- Triggering

The `Directions` supported are:

- Up
- Down
- Left
- Right

For example:

- To denote a composition relationship between the *Stakeholder* and *Business Service* defined above, the syntax will be

```
Rel_Composition(StakeholderElement, BService, "Description for the relationship")
@startuml
!include <archimate/Archimate>
Motivation_Stakeholder(StakeholderElement, "Stakeholder Description")
```



```

Business_Service(BService, "Business Service")
Rel_Composition(StakeholderElement, BService, "Description for the relationship")
@enduml

```

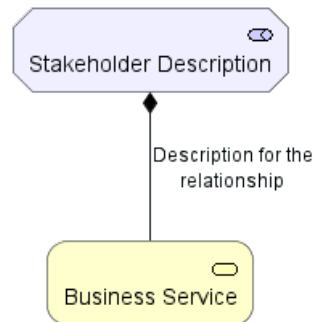

- Unordered List ItemTo orient the two elements in top - down position, the syntax will be

```

Rel_Composition_Down(StakeholderElement, BService, "Description for the relationship")
@startuml
!include <archimate/Archimate>
Motivation_Stakeholder(StakeholderElement, "Stakeholder Description")
Business_Service(BService, "Business Service")
Rel_Composition_Down(StakeholderElement, BService, "Description for the relationship")
@enduml

```

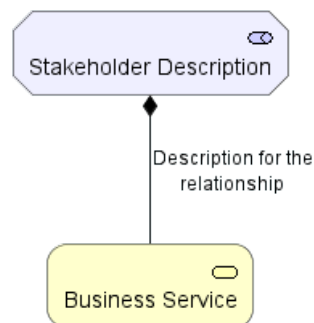

#### 15.6.4 Appendice: Examples of all Archimate RelationTypes

```

@startuml
left to right direction
skinparam nodesep 4
!include <archimate/Archimate>
Rel_Triggering(i15, j15, Triggering)
Rel_Specialization(i14, j14, Specialization)
Rel_Serving(i13, j13, Serving)
Rel_Realization(i12, j12, Realization)
Rel_Influence(i11, j11, Influence)
Rel_Flow(i10, j10, Flow)
Rel_Composition(i9, j9, Composition)
Rel_Association_dir(i8, j8, Association_dir)
Rel_Association(i7, j7, Association)
Rel_Assignment(i6, j6, Assignment)
Rel_Aggregation(i5, j5, Aggregation)
Rel_Access_w(i4, j4, Access_w)
Rel_Access_rw(i3, j3, Access_rw)
Rel_Access_r(i2, j2, Access_r)
Rel_Access(i1, j1, Access)
@enduml

```



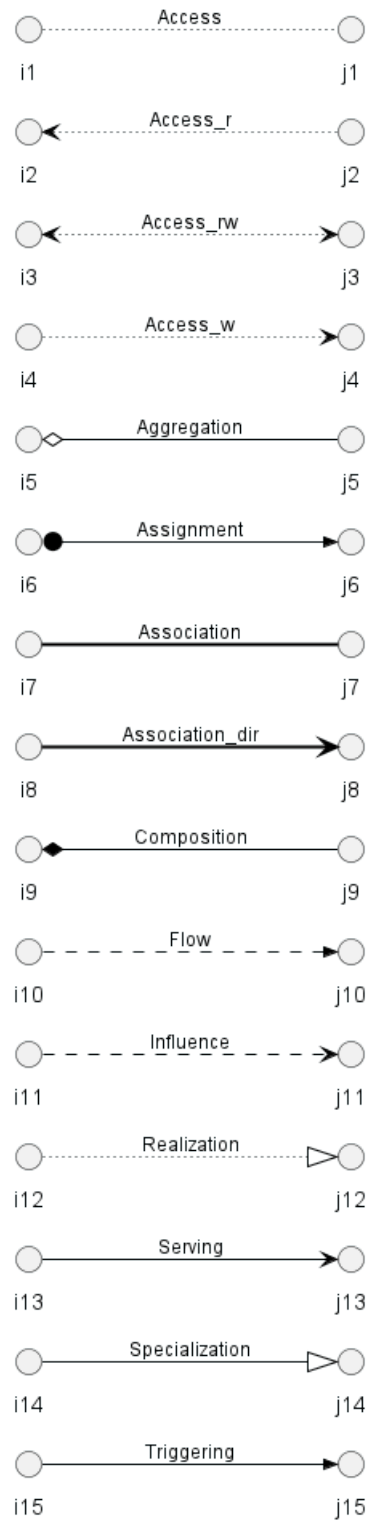

```

@startuml
title ArchiMate Relationships Overview
skinparam nodesep 5
<style>
interface {
    shadowing 0
    backgroundcolor transparent
    linecolor transparent
    FontColor transparent

```

```

}
</style>
!include <archimate/ArchiMate>
left to right direction

rectangle Other {
() i14
() j14
}

rectangle Dynamic {
() i10
() j10
() i15
() j15
}

rectangle Dependency {
() i13
() j13
() i4
() j4
() i11
() j11
() i7
() j7
}

rectangle Structural {
() i9
() j9
() i5
() j5
() i6
() j6
() i12
() j12
}

Rel_Triggering(i15, j15, Triggering)
Rel_Specialization(i14, j14, Specialization)
Rel_Serving(i13, j13, Serving)
Rel_Realization(i12, j12, Realization)
Rel_Influence(i11, j11, Influence)
Rel_Flow(i10, j10, Flow)
Rel_Composition(i9, j9, Composition)
Rel_Association_dir(i7, j7, \nAssociation_dir)
Rel_Association(i7, j7, Association)
Rel_Assignment(i6, j6, Assignment)
Rel_Aggregation(i5, j5, Aggregation)
Rel_Access_w(i4, j4, Access_w)
Rel_Access_rw(i4, j4, Access_rw)
Rel_Access_r(i4, j4, Access_r)
Rel_Access(i4, j4, Access)
@enduml

```

**ArchiMate Relationships Overview**

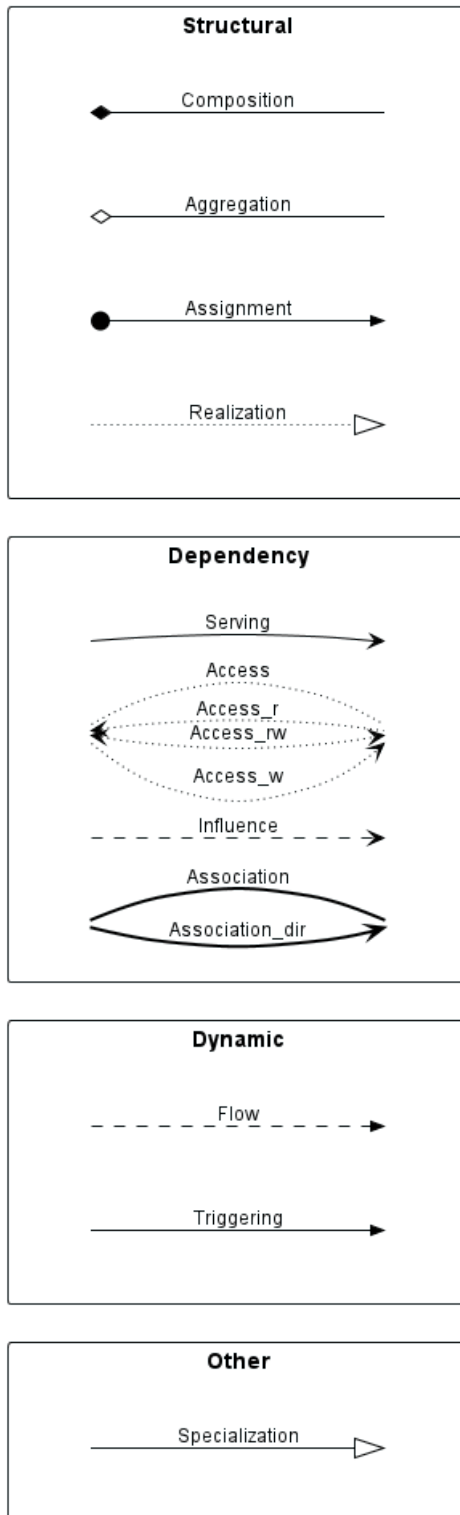

[Adapted from Archimate PR#25]

## 16 Gantt Diagram

The Gantt is described in *natural* language, using very simple sentences (subject-verb-complement).

### 16.1 Declaring tasks

Tasks defined using square bracket.

#### 16.1.1 Duration

Their durations are defined using the `last` verb:

```
@startgantt
[Prototype design] lasts 15 days
[Test prototype] lasts 10 days
-- All example --
[Task 1 (1 day)] lasts 1 day
[T2 (5 days)] lasts 5 days
[T3 (1 week)] lasts 1 week
[T4 (1 week and 4 days)] lasts 1 week and 4 days
[T5 (2 weeks)] lasts 2 weeks
@endgantt
```

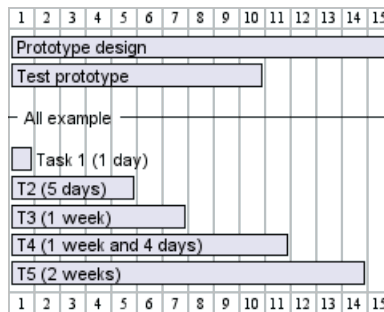

A week is a synonym for how many non-closed days are in a week. So if you specify Saturday and Sunday as closed, a week will be equivalent to 5 days

#### 16.1.2 Start

Their beginning are defined using the `start` verb:

```
@startgantt
[Prototype design] lasts 15 days
[Test prototype] lasts 10 days

Project starts 2020-07-01
[Prototype design] starts 2020-07-01
[Test prototype] starts 2020-07-16
@endgantt
```

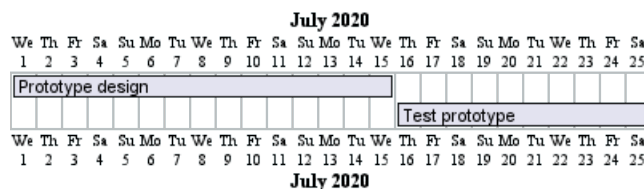

```
@startgantt
[Prototype design] lasts 15 days
[Test prototype] lasts 10 days

[Prototype design] starts D+0
```



```
[Test prototype] starts D+15
@endgantt
```

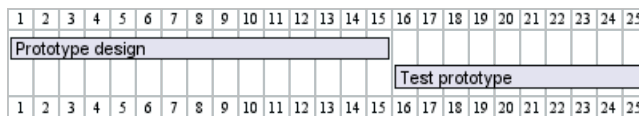

[Ref. for D+nn form: QA-14494]

### 16.1.3 End

Their ending are defined using the end verb:

```
@startgantt
[Prototype design] lasts 15 days
[Test prototype] lasts 10 days
```

```
Project starts 2020-07-01
[Prototype design] ends 2020-07-15
[Test prototype] ends 2020-07-25
@endgantt
```

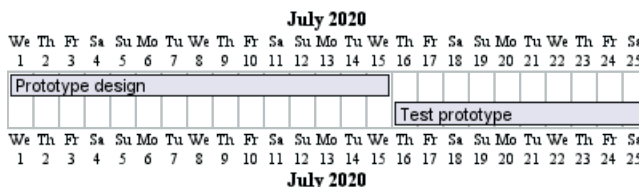

```
@startgantt
[Prototype design] lasts 15 days
[Test prototype] lasts 10 days
```

```
[Prototype design] ends D+14
[Test prototype] ends D+24
@endgantt
```

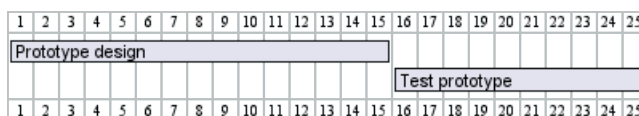

### 16.1.4 Start/End

It is possible to define both absolutely, by specifying dates:

```
@startgantt
Project starts 2020-07-01
[Prototype design] starts 2020-07-01
[Test prototype] starts 2020-07-16
[Prototype design] ends 2020-07-15
[Test prototype] ends 2020-07-25
```

```
@endgantt
```

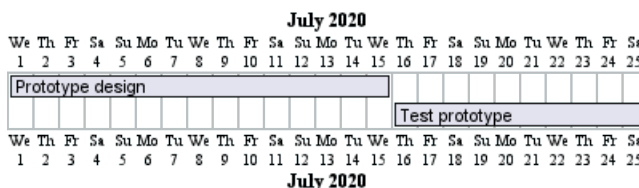

```
@startgantt
```

```
[Prototype design] starts D+0
[Test prototype] starts D+15
[Prototype design] ends D+14
[Test prototype] ends D+24
@endgantt
```

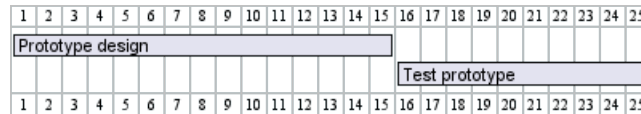

## 16.2 One-line declaration (with the and conjunction)

It is possible to combine declaration on one line with the `and` conjunction.

```
@startgantt
Project starts 2020-07-01
[Prototype design] starts 2020-07-01 and ends 2020-07-15
[Test prototype] starts 2020-07-16 and lasts 10 days
@endgantt
```

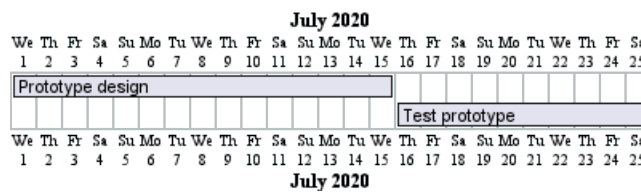

## 16.3 Adding constraints

It is possible to add constraints between tasks.

```
@startgantt
[Prototype design] lasts 15 days
[Test prototype] lasts 10 days
[Test prototype] starts at [Prototype design]'s end
@endgantt
```

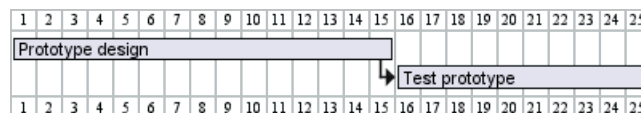

```
@startgantt
[Prototype design] lasts 10 days
[Code prototype] lasts 10 days
[Write tests] lasts 5 days
[Code prototype] starts at [Prototype design]'s end
[Write tests] starts at [Code prototype]'s start
@endgantt
```

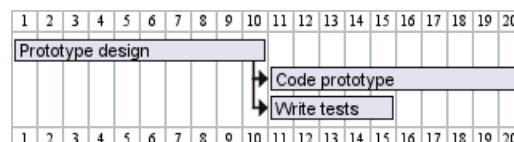

## 16.4 Short names

It is possible to define short name for tasks with the `as` keyword.

```
@startgantt
[Prototype design] as [D] lasts 15 days
[Test prototype] as [T] lasts 10 days
```



```
[T] starts at [D]'s end
@endgantt
```

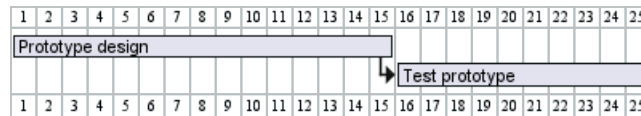

## 16.5 Customize colors

It is also possible to customize colors with `is colored in`.

```
@startgantt
[Prototype design] lasts 13 days
[Test prototype] lasts 4 days
[Test prototype] starts at [Prototype design]'s end
[Prototype design] is colored in Fuchsia/FireBrick
[Test prototype] is colored in GreenYellow/Green
@endgantt
```

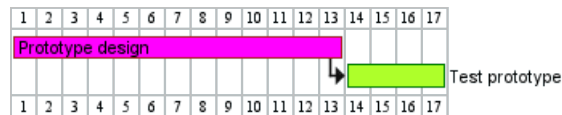

## 16.6 Completion status

### 16.6.1 Adding completion depending percentage

You can set the completion status of a task, by the command:

- `is xx%` completed
- `is xx%` complete

```
@startgantt
[foo] lasts 21 days
[foo] is 40% completed
[bar] lasts 30 days and is 10% complete
@endgantt
```

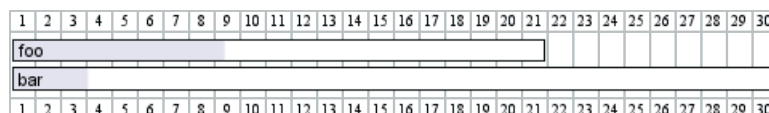

### 16.6.2 Change colour of completion (by style)

```
@startgantt
```

```
<style>
ganttDiagram {
  task {
    BackGroundColor GreenYellow
    LineColor Green
    unstarted {
      BackGroundColor Fuchsia
      LineColor FireBrick
    }
  }
}
</style>
```

```
[Prototype design] lasts 7 days
```



```

[Test prototype 0] lasts 4 days
[Test prototype 10] lasts 4 days
[Test prototype 20] lasts 4 days
[Test prototype 30] lasts 4 days
[Test prototype 40] lasts 4 days
[Test prototype 50] lasts 4 days
[Test prototype 60] lasts 4 days
[Test prototype 70] lasts 4 days
[Test prototype 80] lasts 4 days
[Test prototype 90] lasts 4 days
[Test prototype 100] lasts 4 days

```

```

[Test prototype 0] starts at [Prototype design]'s end
[Test prototype 10] starts at [Prototype design]'s end
[Test prototype 20] starts at [Prototype design]'s end
[Test prototype 30] starts at [Prototype design]'s end
[Test prototype 40] starts at [Prototype design]'s end
[Test prototype 50] starts at [Prototype design]'s end
[Test prototype 60] starts at [Prototype design]'s end
[Test prototype 70] starts at [Prototype design]'s end
[Test prototype 80] starts at [Prototype design]'s end
[Test prototype 90] starts at [Prototype design]'s end
[Test prototype 100] starts at [Prototype design]'s end

```

```

[Test prototype 0] is 0% complete
[Test prototype 10] is 10% complete
[Test prototype 20] is 20% complete
[Test prototype 30] is 30% complete
[Test prototype 40] is 40% complete
[Test prototype 50] is 50% complete
[Test prototype 60] is 60% complete
[Test prototype 70] is 70% complete
[Test prototype 80] is 80% complete
[Test prototype 90] is 90% complete
[Test prototype 100] is 100% complete

```

```
@endgantt
```

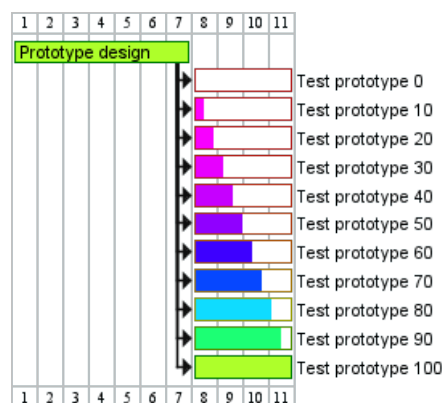

[Ref. QA-8297]

## 16.7 Milestone

You can define Milestones using the **happen** verb.



### 16.7.1 Relative milestone (use of constraints)

```
@startgantt
[Test prototype] lasts 10 days
[Prototype completed] happens at [Test prototype]'s end
[Setup assembly line] lasts 12 days
[Setup assembly line] starts at [Test prototype]'s end
@endgantt
```

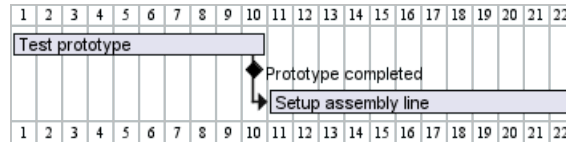

### 16.7.2 Absolute milestone (use of fixed date)

```
@startgantt
Project starts 2020-07-01
[Test prototype] lasts 10 days
[Prototype completed] happens 2020-07-10
[Setup assembly line] lasts 12 days
[Setup assembly line] starts at [Test prototype]'s end
@endgantt
```

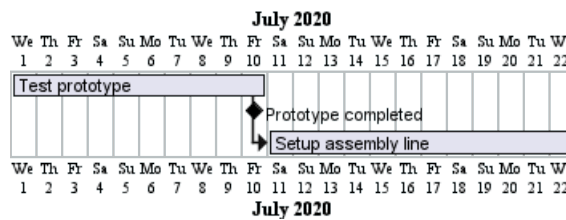

### 16.7.3 Milestone of maximum end of tasks

```
@startgantt
[Task1] lasts 4 days
then [Task1.1] lasts 4 days
[Task1.2] starts at [Task1]'s end and lasts 7 days

[Task2] lasts 5 days
then [Task2.1] lasts 4 days

[MaxTaskEnd] happens at [Task1.1]'s end
[MaxTaskEnd] happens at [Task1.2]'s end
[MaxTaskEnd] happens at [Task2.1]'s end
@endgantt
```

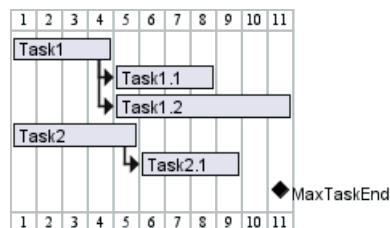

[Ref. QA-10764]

## 16.8 Hyperlinks

You can add hyperlinks to tasks.



```
@startgantt
[task1] lasts 10 days
[task1] links to [[http://plantuml.com]]
@endgantt
```

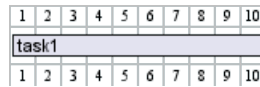

## 16.9 Calendar

You can specify a starting date for the whole project. By default, the first task starts at this date.

```
@startgantt
Project starts the 20th of september 2017
[Prototype design] as [TASK1] lasts 13 days
[TASK1] is colored in Lavender/LightBlue
@endgantt
```

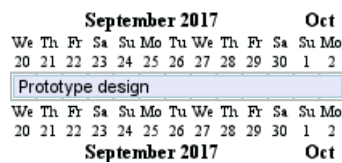

## 16.10 Coloring days

It is possible to add colors to some days.

```
@startgantt
Project starts the 2020/09/01

2020/09/07 is colored in salmon
2020/09/13 to 2020/09/16 are colored in lightblue

[Prototype design] as [TASK1] lasts 22 days
[TASK1] is colored in Lavender/LightBlue
[Prototype completed] happens at [TASK1]'s end
@endgantt
```

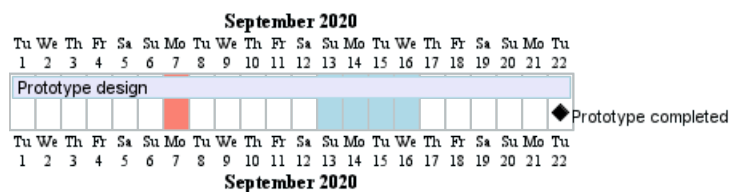

## 16.11 Changing scale

You can change scale for very long project, with one of those parameters:

- printscale
- gantt scale
- project scale

and one of the values:

- daily (*by default*)
- weekly
- monthly



- quarterly
- yearly

(See QA-11272, QA-9041 and QA-10948)

### 16.11.1 Daily (by default)

```
@startgantt
saturday are closed
sunday are closed
```

```
Project starts the 1st of january 2021
[Prototype design end] as [TASK1] lasts 19 days
[TASK1] is colored in Lavender/LightBlue
[Testing] lasts 14 days
[TASK1]->[Testing]
```

```
2021-01-18 to 2021-01-22 are named [End's committee]
2021-01-18 to 2021-01-22 are colored in salmon
@endgantt
```

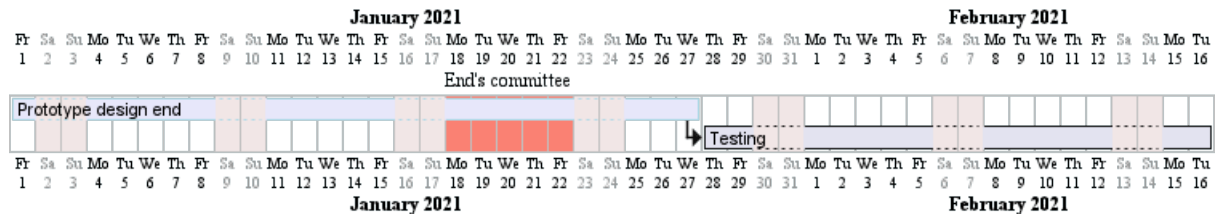

### 16.11.2 Weekly

```
@startgantt
printscale weekly
saturday are closed
sunday are closed
```

```
Project starts the 1st of january 2021
[Prototype design end] as [TASK1] lasts 19 days
[TASK1] is colored in Lavender/LightBlue
[Testing] lasts 14 days
[TASK1]->[Testing]
```

```
2021-01-18 to 2021-01-22 are named [End's committee]
2021-01-18 to 2021-01-22 are colored in salmon
@endgantt
```

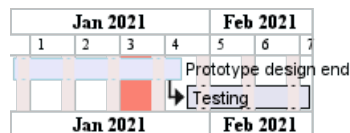

```
@startgantt
printscale weekly
Project starts the 20th of september 2020
[Prototype design] as [TASK1] lasts 130 days
[TASK1] is colored in Lavender/LightBlue
[Testing] lasts 20 days
[TASK1]->[Testing]
```

```
2021-01-18 to 2021-01-22 are named [End's committee]
```

2021-01-18 to 2021-01-22 are colored in salmon  
 @endgantt

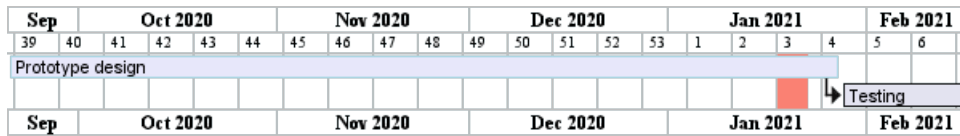

### 16.11.3 Monthly

```
@startgantt
projectscale monthly
Project starts the 20th of september 2020
[Prototype design] as [TASK1] lasts 130 days
[TASK1] is colored in Lavender/LightBlue
[Testing] lasts 20 days
[TASK1]->[Testing]
```

2021-01-18 to 2021-01-22 are named [End's committee]  
 2021-01-18 to 2021-01-22 are colored in salmon  
 @endgantt

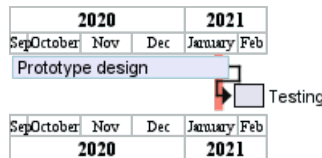

### 16.11.4 Quarterly

```
@startgantt
projectscale quarterly
Project starts the 20th of september 2020
[Prototype design] as [TASK1] lasts 130 days
[TASK1] is colored in Lavender/LightBlue
[Testing] lasts 20 days
[TASK1]->[Testing]
```

2021-01-18 to 2021-01-22 are named [End's committee]  
 2021-01-18 to 2021-01-22 are colored in salmon  
 @endgantt

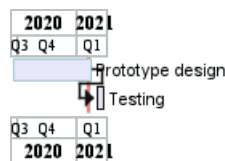

```
@startgantt
projectscale quarterly
Project starts the 1st of october 2020
[Prototype design] as [TASK1] lasts 700 days
[TASK1] is colored in Lavender/LightBlue
[Testing] lasts 200 days
[TASK1]->[Testing]
```

2021-01-18 to 2021-03-22 are colored in salmon  
 @endgantt



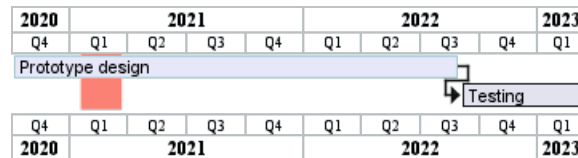

16.11.5 Yearly

```
@startgantt
projectscale yearly
Project starts the 1st of october 2020
[Prototype design] as [TASK1] lasts 700 days
[TASK1] is colored in Lavender/LightBlue
[Testing] lasts 200 days
[TASK1]->[Testing]
```

```
2021-01-18 to 2021-03-22 are colored in salmon
@endgantt
```

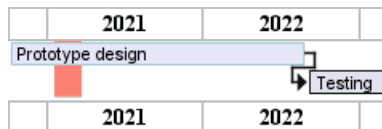

16.12 Zoom (example for all scale)

You can change zoom, with the parameter:

- zoom <integer>

16.12.1 Zoom on weekly scale

16.12.2 Without zoom

```
@startgantt
printscale daily
saturday are closed
sunday are closed
```

```
Project starts the 1st of january 2021
[Prototype design end] as [TASK1] lasts 8 days
[TASK1] is colored in Lavender/LightBlue
[Testing] lasts 3 days
[TASK1]->[Testing]
```

```
2021-01-18 to 2021-01-22 are named [End's committee]
2021-01-18 to 2021-01-22 are colored in salmon
@endgantt
```

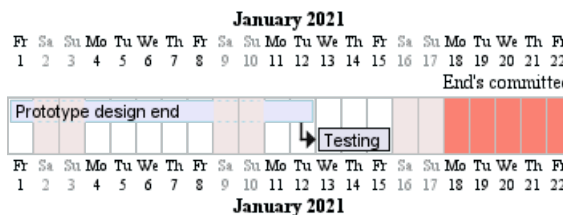

16.12.3 With zoom

```
@startgantt
printscale daily zoom 2
```

saturday are closed  
sunday are closed

Project starts the 1st of january 2021  
[Prototype design end] as [TASK1] lasts 8 days  
[TASK1] is colored in Lavender/LightBlue  
[Testing] lasts 3 days  
[TASK1]->[Testing]

2021-01-18 to 2021-01-22 are named [End's committee]  
2021-01-18 to 2021-01-22 are colored in salmon  
@endgantt

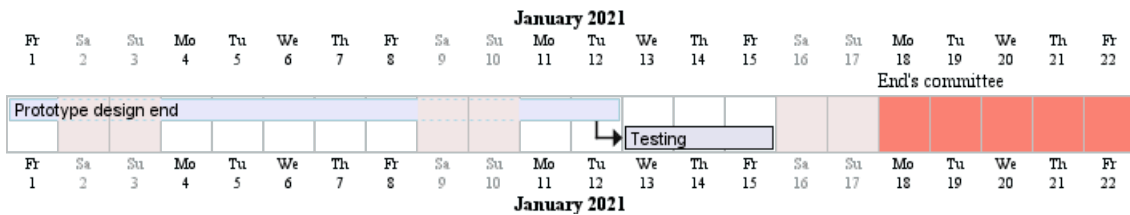

[Ref. QA-13725]

#### 16.12.4 Zoom on weekly scale

#### 16.12.5 Without zoom

@startgantt  
printscales weekly  
saturday are closed  
sunday are closed

Project starts the 1st of january 2021  
[Prototype design end] as [TASK1] lasts 19 days  
[TASK1] is colored in Lavender/LightBlue  
[Testing] lasts 14 days  
[TASK1]->[Testing]

2021-01-18 to 2021-01-22 are named [End's committee]  
2021-01-18 to 2021-01-22 are colored in salmon  
@endgantt

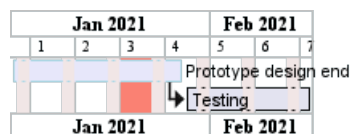

#### 16.12.6 With zoom

@startgantt  
printscales weekly zoom 4  
saturday are closed  
sunday are closed

Project starts the 1st of january 2021  
[Prototype design end] as [TASK1] lasts 19 days  
[TASK1] is colored in Lavender/LightBlue  
[Testing] lasts 14 days  
[TASK1]->[Testing]

2021-01-18 to 2021-01-22 are named [End's committee]





2021-01-18 to 2021-01-22 are colored in salmon  
 @endgantt

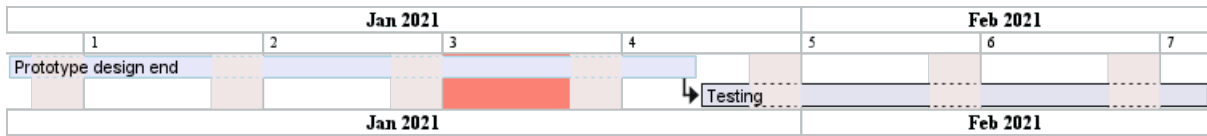

16.12.7 Zoom on monthly scale

16.12.8 Without zoom

@startgantt  
 projectscale monthly  
 Project starts the 20th of september 2020  
 [Prototype design] as [TASK1] lasts 130 days  
 [TASK1] is colored in Lavender/LightBlue  
 [Testing] lasts 20 days  
 [TASK1]->[Testing]

2021-01-18 to 2021-01-22 are named [End's committee]  
 2021-01-18 to 2021-01-22 are colored in salmon  
 @endgantt

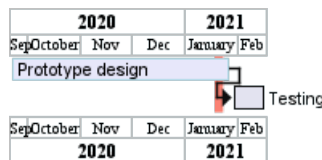

16.12.9 With zoom

@startgantt  
 projectscale monthly zoom 3  
 Project starts the 20th of september 2020  
 [Prototype design] as [TASK1] lasts 130 days  
 [TASK1] is colored in Lavender/LightBlue  
 [Testing] lasts 20 days  
 [TASK1]->[Testing]

2021-01-18 to 2021-01-22 are named [End's committee]  
 2021-01-18 to 2021-01-22 are colored in salmon  
 @endgantt

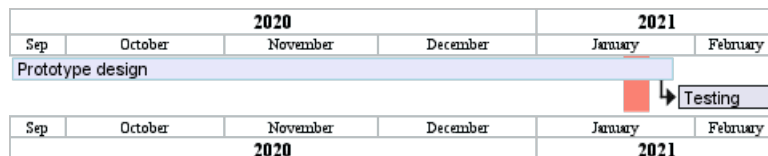

16.12.10 Zoom on quarterly scale

16.12.11 Without zoom

@startgantt  
 projectscale quarterly  
 Project starts the 20th of september 2020  
 [Prototype design] as [TASK1] lasts 130 days  
 [TASK1] is colored in Lavender/LightBlue  
 [Testing] lasts 20 days  
 [TASK1]->[Testing]

2021-01-18 to 2021-01-22 are named [End's committee]  
 2021-01-18 to 2021-01-22 are colored in salmon  
 @endganttt

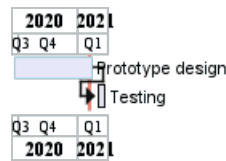

### 16.12.12 With zoom

```
@startganttt
projectscale quarterly zoom 7
Project starts the 20th of september 2020
[Prototype design] as [TASK1] lasts 130 days
[TASK1] is colored in Lavender/LightBlue
[Testing] lasts 20 days
[TASK1]->[Testing]
```

2021-01-18 to 2021-01-22 are named [End's committee]  
 2021-01-18 to 2021-01-22 are colored in salmon  
 @endganttt

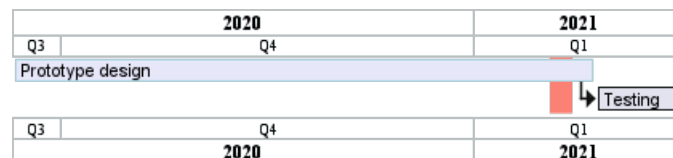

### 16.12.13 Zoom on yearly scale

#### 16.12.14 Without zoom

```
@startganttt
projectscale yearly
Project starts the 1st of october 2020
[Prototype design] as [TASK1] lasts 700 days
[TASK1] is colored in Lavender/LightBlue
[Testing] lasts 200 days
[TASK1]->[Testing]
```

2021-01-18 to 2021-03-22 are colored in salmon  
 @endganttt

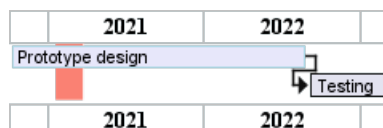

### 16.12.15 With zoom

```
@startganttt
projectscale yearly zoom 2
Project starts the 1st of october 2020
[Prototype design] as [TASK1] lasts 700 days
[TASK1] is colored in Lavender/LightBlue
[Testing] lasts 200 days
[TASK1]->[Testing]
```



2021-01-18 to 2021-03-22 are colored in salmon  
 @endgantt

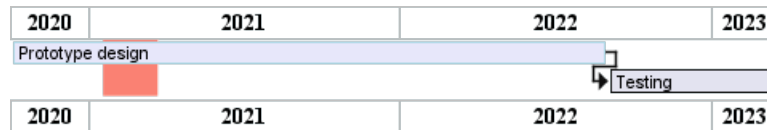

## 16.13 Weekscale with Weeknumbers or Calendar Date

### 16.13.1 With Weeknumbers (*by default*)

```
@startgantt
printscale weekly
Project starts the 6th of July 2020
[Task1] on {Alice} lasts 2 weeks
[Task2] on {Bob:50%} lasts 2 weeks
then [Task3] on {Alice:25%} lasts 3 days
@endgantt
```

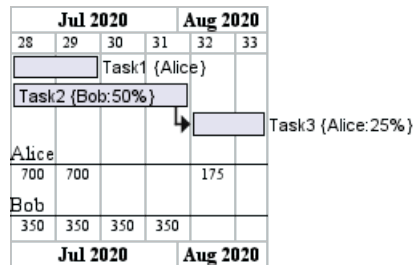

### 16.13.2 With Calendar Date

```
@startgantt
printscale weekly with calendar date
Project starts the 6th of July 2020
[Task1] on {Alice} lasts 2 weeks
[Task2] on {Bob:50%} lasts 2 weeks
then [Task3] on {Alice:25%} lasts 3 days
@endgantt
```

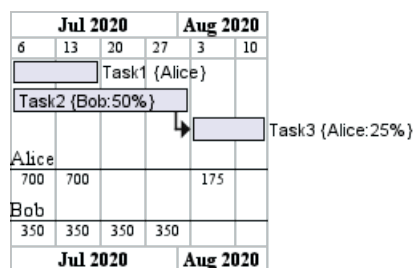

[Ref. QA-11630]

## 16.14 Close day

It is possible to close some day.

```
@startgantt
project starts the 2018/04/09
saturday are closed
sunday are closed
2018/05/01 is closed
2018/04/17 to 2018/04/19 is closed
[Prototype design] lasts 14 days
```



```
[Test prototype] lasts 4 days
[Test prototype] starts at [Prototype design]'s end
[Prototype design] is colored in Fuchsia/FireBrick
[Test prototype] is colored in GreenYellow/Green
@endgant
```

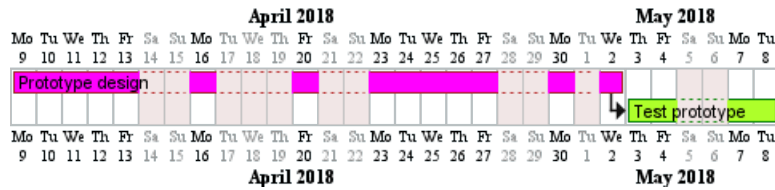

Then it is possible to open some closed day.

```
@startgant
2020-07-07 to 2020-07-17 is closed
2020-07-13 is open

Project starts the 2020-07-01
[Prototype design] lasts 10 days
Then [Test prototype] lasts 10 days
@endgant
```



## 16.15 Definition of a week depending of closed days

A **week** is a synonym for how many non-closed days are in a week, as:

```
@startgant
Project starts 2021-03-29
[Review 01] happens at 2021-03-29
[Review 02 - 3 weeks] happens on 3 weeks after [Review 01]'s end
[Review 02 - 21 days] happens on 21 days after [Review 01]'s end
@endgant
```

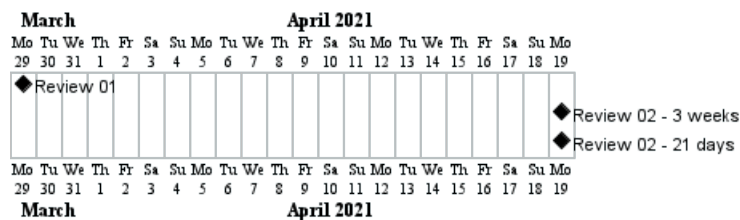

So if you specify *Saturday* and *Sunday* as closed, a **week** will be equivalent to 5 days, as:

```
@startgant
Project starts 2021-03-29
saturday are closed
sunday are closed
[Review 01] happens at 2021-03-29
[Review 02 - 3 weeks] happens on 3 weeks after [Review 01]'s end
[Review 02 - 21 days] happens on 21 days after [Review 01]'s end
@endgant
```



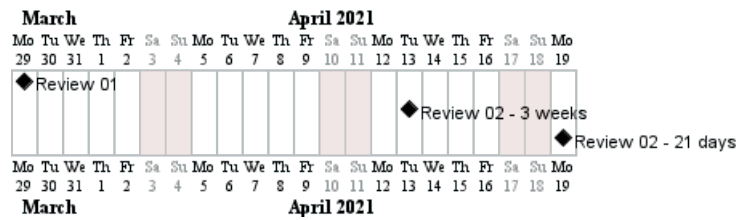

[Ref. QA-13434]

## 16.16 Working days

It is possible to manage working days.

```
@startgantt
```

```
saturday are closed
```

```
sunday are closed
```

```
2022-07-04 to 2022-07-15 is closed
```

```
Project starts 2022-06-27
```

```
[task1] starts at 2022-06-27 and lasts 1 week
```

```
[task2] starts 2 working days after [task1]'s end and lasts 3 days
```

```
@endgantt
```

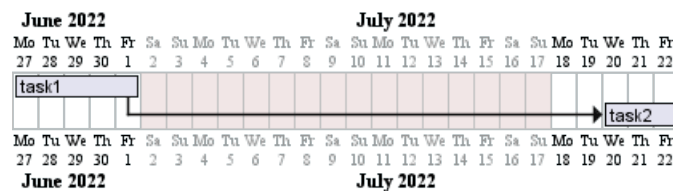

[Ref. QA-16188]

## 16.17 Simplified task succession

It's possible to use the then keyword to denote consecutive tasks.

```
@startgantt
```

```
[Prototype design] lasts 14 days
```

```
then [Test prototype] lasts 4 days
```

```
then [Deploy prototype] lasts 6 days
```

```
@endgantt
```

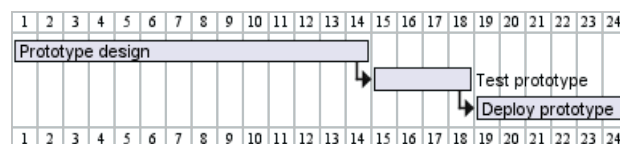

You can also use arrow ->

```
@startgantt
```

```
[Prototype design] lasts 14 days
```

```
[Build prototype] lasts 4 days
```

```
[Prepare test] lasts 6 days
```

```
[Prototype design] -> [Build prototype]
```

```
[Prototype design] -> [Prepare test]
```

```
@endgantt
```



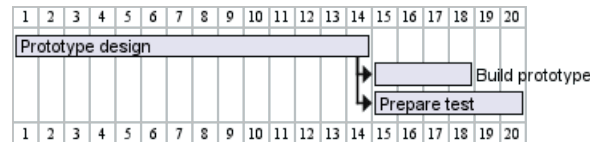

## 16.18 Working with resources

You can affect tasks on resources using the on keyword and brackets for resource name.

```
@startgantt
[Task1] on {Alice} lasts 10 days
[Task2] on {Bob:50%} lasts 2 days
then [Task3] on {Alice:25%} lasts 1 days
@endgantt
```

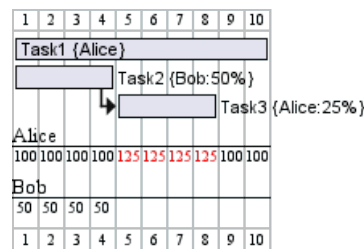

Multiple resources can be assigned to a task:

```
@startgantt
[Task1] on {Alice} {Bob} lasts 20 days
@endgantt
```

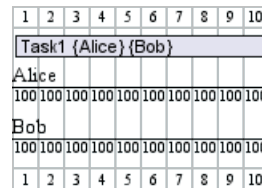

Resources can be marked as off on specific days:

```
@startgantt
project starts on 2020-06-19
[Task1] on {Alice} lasts 10 days
{Alice} is off on 2020-06-24 to 2020-06-26
@endgantt
```

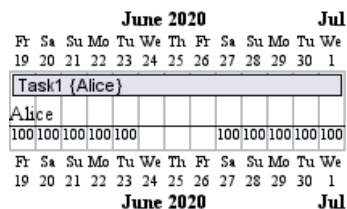

## 16.19 Hide resources

### 16.19.1 Without any hiding (by default)

```
@startgantt
[Task1] on {Alice} lasts 10 days
[Task2] on {Bob:50%} lasts 2 days
then [Task3] on {Alice:25%} lasts 1 days
then [Task4] on {Alice:25%} {Bob} lasts 1 days
@endgantt
```



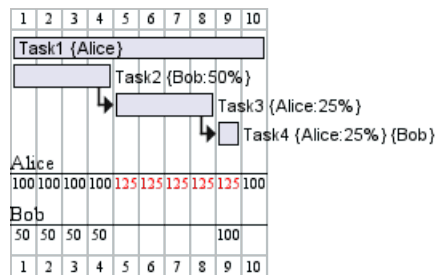

### 16.19.2 Hide resources names

You can hide resources names and percentage, on tasks, using the `hide resources names` keywords.

```
@startgantt
hide resources names
[Task1] on {Alice} lasts 10 days
[Task2] on {Bob:50%} lasts 2 days
then [Task3] on {Alice:25%} lasts 1 days
then [Task4] on {Alice:25%} {Bob} lasts 1 days
@endgantt
```

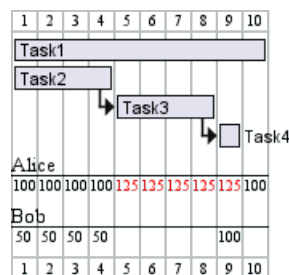

### 16.19.3 Hide resources footbox

You can also hide resources names on bottom of the diagram using the `hide resources footbox` keywords.

```
@startgantt
hide resources footbox
[Task1] on {Alice} lasts 10 days
[Task2] on {Bob:50%} lasts 2 days
then [Task3] on {Alice:25%} lasts 1 days
then [Task4] on {Alice:25%} {Bob} lasts 1 days
@endgantt
```

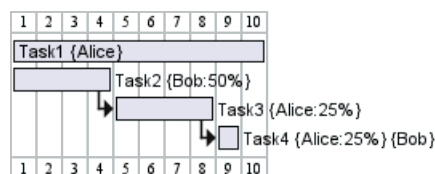

### 16.19.4 Hide the both (resources names and resources footbox)

You can also hide the both.

```
@startgantt
hide resources names
hide resources footbox
[Task1] on {Alice} lasts 10 days
[Task2] on {Bob:50%} lasts 2 days
then [Task3] on {Alice:25%} lasts 1 days
then [Task4] on {Alice:25%} {Bob} lasts 1 days
```



```
@endgantt
```

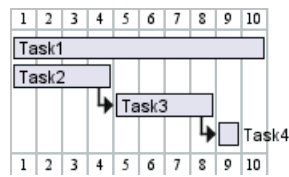

## 16.20 Horizontal Separator

You can use `--` to separate sets of tasks.

```
@startgantt
[Task1] lasts 10 days
then [Task2] lasts 4 days
-- Phase Two --
then [Task3] lasts 5 days
then [Task4] lasts 6 days
@endgantt
```

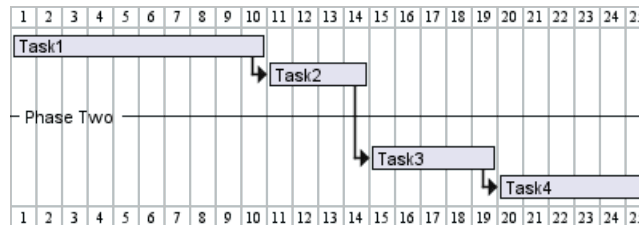

## 16.21 Vertical Separator

You can add Vertical Separators with the syntax: `Separator just [at]`.

```
@startgantt
[task1] lasts 1 week
[task2] starts 20 days after [task1]'s end and lasts 3 days

Separator just at [task1]'s end
Separator just 2 days after [task1]'s end

Separator just at [task2]'s start
Separator just 2 days before [task2]'s start
@endgantt
```

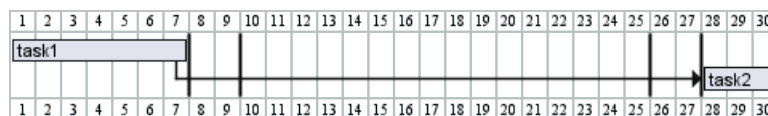

[Ref. QA-16247]

## 16.22 Complex example

It also possible to use the `and` conjunction.

You can also add delays in constraints.

```
@startgantt
[Prototype design] lasts 13 days and is colored in Lavender/LightBlue
[Test prototype] lasts 9 days and is colored in Coral/Green and starts 3 days after [Prototype design]
[Write tests] lasts 5 days and ends at [Prototype design]'s end
[Hire tests writers] lasts 6 days and ends at [Write tests]'s start
[Init and write tests report] is colored in Coral/Green
```





[Init and write tests report] starts 1 day before [Test prototype]'s start and ends at [Test prototype]



## 16.23 Comments

As is mentioned on Common Commands page: `blockquote` Everything that starts with `simple quote` ' is a comment.

You can also put comments on several lines using `/'` to start and `/'` to end. `blockquote` (i.e.: the first character (except space character) of a comment line must be a *simple quote* ')

```
@startgantt
' This is a comment
```

```
[T1] lasts 3 days
```

```
/' this comment
is on several lines '/
```

```
[T2] starts at [T1]'s end and lasts 1 day
@endgantt
```

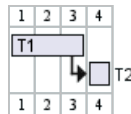

## 16.24 Using style

### 16.24.1 Without style (by default)

```
@startgantt
[Task1] lasts 20 days
note bottom
  memo1 ...
  memo2 ...
  explanations1 ...
  explanations2 ...
end note
[Task2] lasts 4 days
[Task1] -> [Task2]
-- Separator title --
[M1] happens on 5 days after [Task1]'s end
-- end --
@endgantt
```



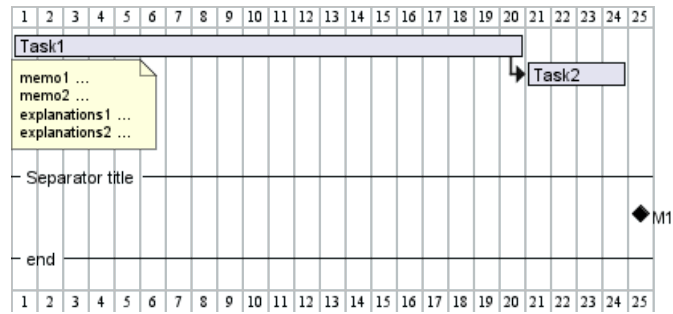

### 16.24.2 With style

You can use style to change rendering of elements.

```

@startgantt
<style>
ganttDiagram {
task {
  FontName Helvetica
  FontColor red
  FontSize 18
  FontStyle bold
  BackGroundColor GreenYellow
  LineColor blue
}
milestone {
  FontColor blue
  FontSize 25
  FontStyle italic
  BackGroundColor yellow
  LineColor red
}
note {
  FontColor DarkGreen
  FontSize 10
  LineColor OrangeRed
}
arrow {
  FontName Helvetica
  FontColor red
  FontSize 18
  FontStyle bold
  BackGroundColor GreenYellow
  LineColor blue
}
separator {
  LineColor red
  BackGroundColor green
  FontSize 16
  FontStyle bold
  FontColor purple
}
}
</style>
[Task1] lasts 20 days
note bottom
  memo1 ...
  memo2 ...

```



```

    explanations1 ...
    explanations2 ...
end note
[Task2] lasts 4 days
[Task1] -> [Task2]
-- Separator title --
[M1] happens on 5 days after [Task1]'s end
-- end --
@endgantt

```

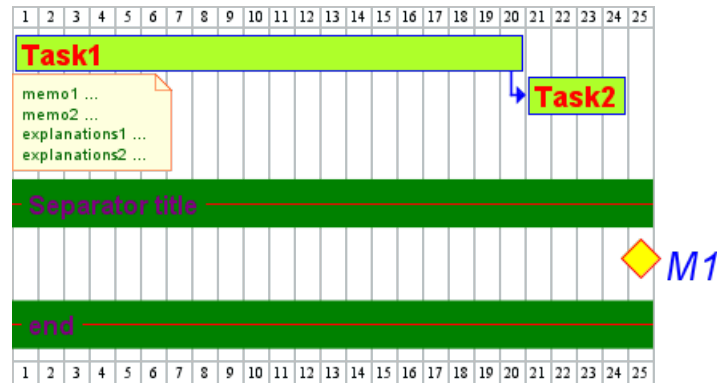

[Ref. QA-10835, QA-12045, QA-11877 and PR-438]

### 16.24.3 With style (full example)

```

@startgantt
<style>
ganttDiagram {
task {
FontName Helvetica
FontColor red
FontSize 18
FontStyle bold
BackgroundColor GreenYellow
LineColor blue
}
milestone {
FontColor blue
FontSize 25
FontStyle italic
BackgroundColor yellow
LineColor red
}
note {
FontColor DarkGreen
FontSize 10
LineColor OrangeRed
}
arrow {
FontName Helvetica
FontColor red
FontSize 18
FontStyle bold
BackgroundColor GreenYellow
LineColor blue
LineStyle 8.0;13.0
LineThickness 3.0
}

```



```

separator {
BackgroundColor lightGreen
LineStyle 8.0;3.0
LineColor red
LineThickness 1.0
FontSize 16
FontStyle bold
FontColor purple
Margin 5
Padding 20
}
timeline {
    BackgroundColor Bisque
}
closed {
BackgroundColor pink
FontColor red
}
}
</style>
Project starts the 2020-12-01

[Task1] lasts 10 days
sunday are closed

note bottom
    memo1 ...
    memo2 ...
    explanations1 ...
    explanations2 ...
end note

[Task2] lasts 20 days
[Task2] starts 10 days after [Task1]'s end
-- Separator title --
[M1] happens on 5 days after [Task1]'s end

<style>
separator {
    LineColor black
Margin 0
Padding 0
}
</style>

-- end --
@endgantt

```

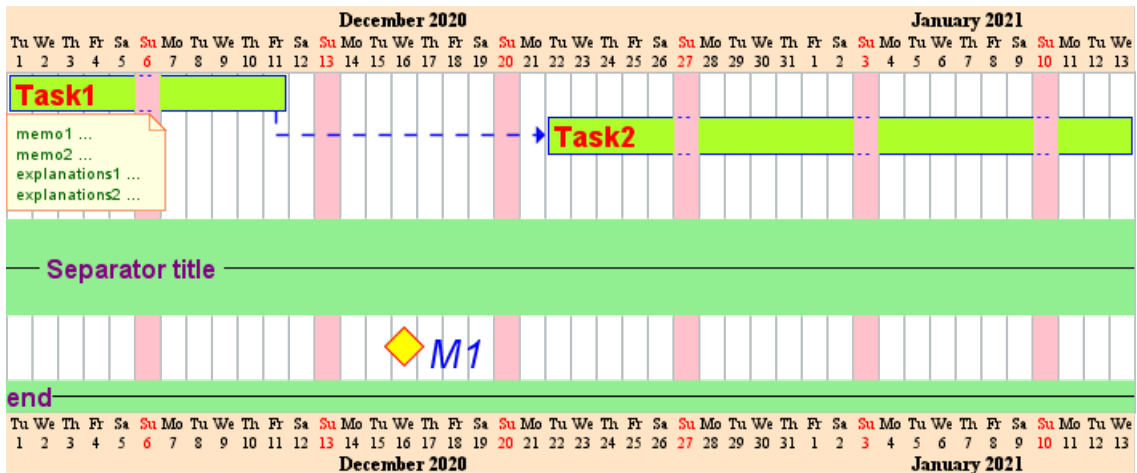

[Ref. QA-13570, QA-13672]

**TODO:** DONE Thanks for style for Separator and all style for Arrow (thickness...)

### 16.24.4 Clean style

With style, you can also clean a Gantt diagram (showing tasks, dependencies and relative durations only - but no actual start date and no actual scale):

```
@startgantt
<style>
ganttDiagram {
  timeline {
    LineColor transparent
    FontColor transparent
  }
}
</style>
```

```
hide footbox
[Test prototype] lasts 7 days
[Prototype completed] happens at [Test prototype]'s end
[Setup assembly line] lasts 9 days
[Setup assembly line] starts at [Test prototype]'s end
then [Setup] lasts 5 days
[T2] lasts 2 days and starts at [Test prototype]'s end
then [T3] lasts 3 days
-- end task --
then [T4] lasts 2 days
@endgantt
```

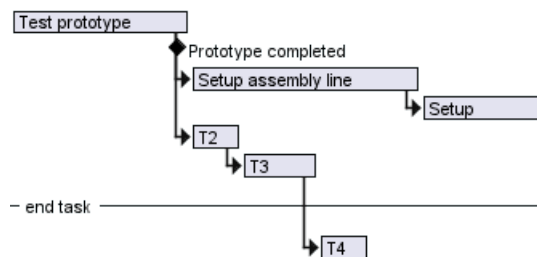

[Ref. QA-13971]

Or:

```
@startgantt
```

```

<style>
ganttdiagram {
  timeline {
    LineColor transparent
    FontColor transparent
  }
  closed {
    FontColor transparent
  }
}
</style>

```

```

hide footbox
project starts the 2018/04/09
saturday are closed
sunday are closed
2018/05/01 is closed
2018/04/17 to 2018/04/19 is closed
[Prototype design] lasts 9 days
[Test prototype] lasts 5 days
[Test prototype] starts at [Prototype design]'s end
[Prototype design] is colored in Fuchsia/FireBrick
[Test prototype] is colored in GreenYellow/Green
@endganttt

```

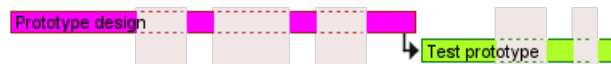

[Ref. QA-13464]

## 16.25 Add notes

```

@startganttt
[task01] lasts 15 days
note bottom
  memo1 ...
  memo2 ...
  explanations1 ...
  explanations2 ...
end note

```

```
[task01] -> [task02]
```

```
@endganttt
```

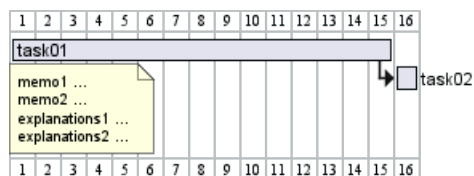

Example with overlap.

```

@startganttt
[task01] lasts 15 days
note bottom
  memo1 ...
  memo2 ...

```



```

    explanations1 ...
    explanations2 ...
end note

[task01] -> [task02]
[task03] lasts 5 days

@endgantt

```

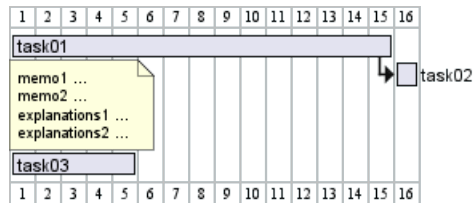

```

@startgantt

-- test01 --

[task01] lasts 4 days
note bottom
'note left
memo1 ...
memo2 ...
explanations1 ...
explanations2 ...
end note

[task02] lasts 8 days
[task01] -> [task02]
note bottom
'note left
memo1 ...
memo2 ...
explanations1 ...
explanations2 ...
end note

-- test02 --

[task03] as [t3] lasts 7 days
[t3] -> [t4]
@endgantt

```

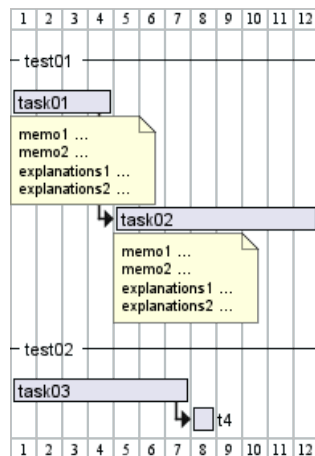

**TODO:** DONE Thanks for correction (of #386 on v1.2020.18) when overlapping

```
@startgantt
```

```
Project starts 2020-09-01
```

```
[taskA] starts 2020-09-01 and lasts 3 days
```

```
[taskB] starts 2020-09-10 and lasts 3 days
```

```
[taskB] displays on same row as [taskA]
```

```
[task01] starts 2020-09-05 and lasts 4 days
```

```
then [task02] lasts 8 days
```

```
note bottom
```

```
  note for task02
```

```
  more notes
```

```
end note
```

```
then [task03] lasts 7 days
```

```
note bottom
```

```
  note for task03
```

```
  more notes
```

```
end note
```

```
-- separator --
```

```
[taskC] starts 2020-09-02 and lasts 5 days
```

```
[taskD] starts 2020-09-09 and lasts 5 days
```

```
[taskD] displays on same row as [taskC]
```

```
[task 10] starts 2020-09-05 and lasts 5 days
```

```
then [task 11] lasts 5 days
```

```
note bottom
```

```
  note for task11
```

```
  more notes
```

```
end note
```

```
@endgantt
```

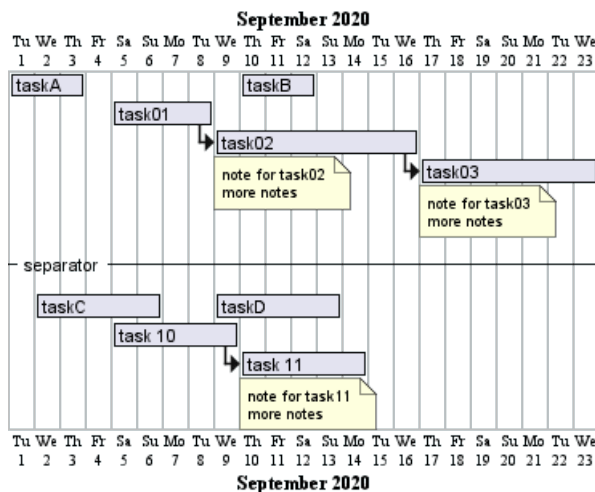

## 16.26 Pause tasks

```
@startgantt
```

```
Project starts the 5th of december 2018
```

```
saturday are closed
```



```
sunday are closed
2018/12/29 is opened
[Prototype design] lasts 17 days
[Prototype design] pauses on 2018/12/13
[Prototype design] pauses on 2018/12/14
[Prototype design] pauses on monday
[Test prototype] starts at [Prototype design]'s end and lasts 2 weeks
@endgantt
```

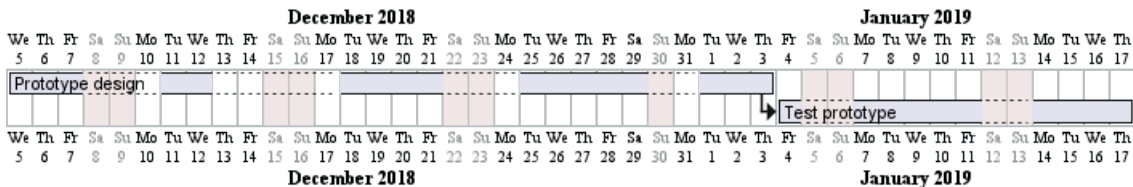

### 16.27 Change link colors

You can change link colors:

- with this syntax: with <color> <style> link

```
@startgantt
[T1] lasts 4 days
[T2] lasts 4 days and starts 3 days after [T1]'s end with blue dotted link
[T3] lasts 4 days and starts 3 days after [T2]'s end with green bold link
[T4] lasts 4 days and starts 3 days after [T3]'s end with green dashed link
@endgantt
```

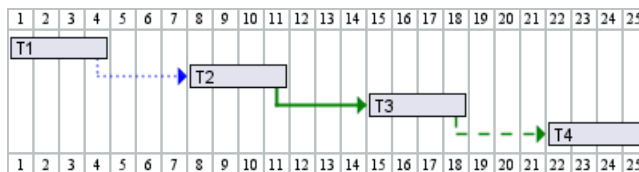

- or directly by using arrow style

```
@startgantt
<style>
ganttdiagram {
  arrow {
    LineColor blue
  }
}
</style>
[Prototype design] lasts 7 days
[Build prototype] lasts 4 days
[Prepare test] lasts 6 days
[Prototype design] -[#FF00FF]-> [Build prototype]
[Prototype design] -[dotted]-> [Prepare test]
Then [Run test] lasts 4 days
@endgantt
```

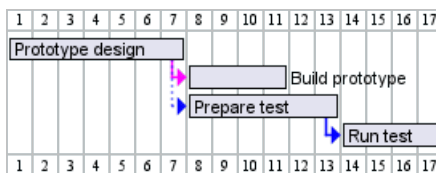

[Ref. QA-13693]

## 16.28 Tasks or Milestones on the same line

You can put Tasks or Milestones on the same line, with this syntax:

- [T|M] displays on same row as [T|M]

```
@startgantt
[Prototype design] lasts 13 days
[Test prototype] lasts 4 days and 1 week
[Test prototype] starts 1 week and 2 days after [Prototype design]'s end
[Test prototype] displays on same row as [Prototype design]
[r1] happens on 5 days after [Prototype design]'s end
[r2] happens on 5 days after [r1]'s end
[r3] happens on 5 days after [r2]'s end
[r2] displays on same row as [r1]
[r3] displays on same row as [r1]
@endgantt
```

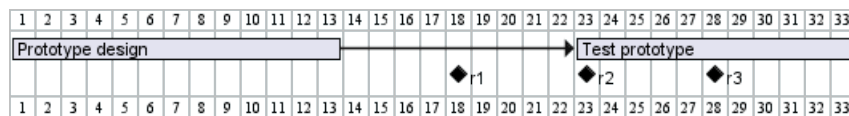

## 16.29 Highlight today

```
@startgantt
Project starts the 20th of september 2018
sunday are close
2018/09/21 to 2018/09/23 are colored in salmon
2018/09/21 to 2018/09/30 are named [Vacation in the Bahamas]
```

```
today is 30 days after start and is colored in #AAF
[Foo] happens 40 days after start
[Dummy] lasts 10 days and starts 10 days after start
```

```
@endgantt
```

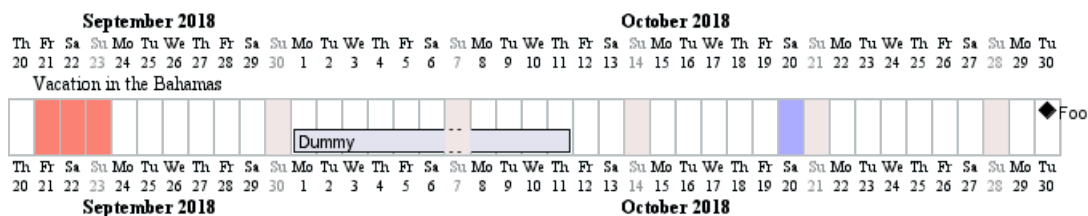

## 16.30 Task between two milestones

```
@startgantt
project starts on 2020-07-01
[P_start] happens 2020-07-03
[P_end] happens 2020-07-13
[Prototype design] occurs from [P_start] to [P_end]
@endgantt
```

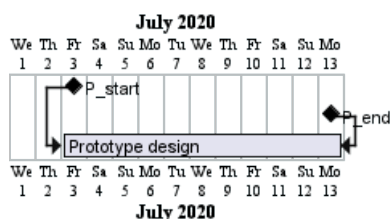

### 16.31 Grammar and verbal form

Verbal form	Example
[ <i>T</i> ] starts	
[ <i>M</i> ] happens	

### 16.32 Add title, header, footer, caption or legend

```
@startgantt
```

```
header some header
```

```
footer some footer
```

```
title My title
```

```
[Prototype design] lasts 13 days
```

```
legend
```

```
The legend
```

```
end legend
```

```
caption This is caption
```

```
@endgantt
```

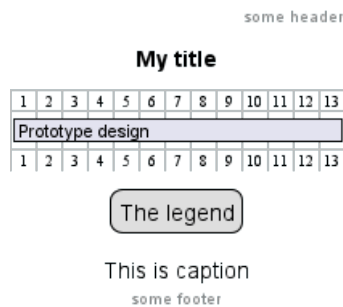

(See also: *Common commands*)

### 16.33 Removing Foot Boxes (example for all scale)

You can use the `hide footbox` keywords to remove the foot boxes of the gantt diagram (*as for sequence diagram*).

Examples on:

- daily scale (*without project start*)

```
@startgantt
```

```
hide footbox
```

```
title Foot Box removed
```

```
[Prototype design] lasts 15 days
```

```
[Test prototype] lasts 10 days
```

```
@endgantt
```

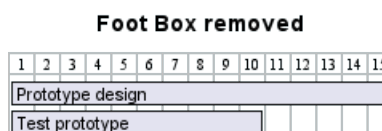

- daily scale

```
@startgantt
```

```
Project starts the 20th of september 2017
[Prototype design] as [TASK1] lasts 13 days
[TASK1] is colored in Lavender/LightBlue
```

```
hide footbox
@endgantt
```

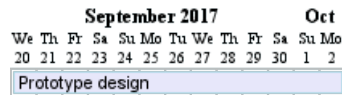

- weekly scale

```
@startgantt
hide footbox
```

```
printscale weekly
saturday are closed
sunday are closed
```

```
Project starts the 1st of january 2021
[Prototype design end] as [TASK1] lasts 19 days
[TASK1] is colored in Lavender/LightBlue
[Testing] lasts 14 days
[TASK1]->[Testing]
```

```
2021-01-18 to 2021-01-22 are named [End's committee]
2021-01-18 to 2021-01-22 are colored in salmon
@endgantt
```

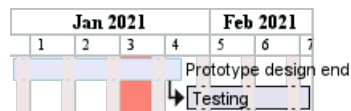

- monthly scale

```
@startgantt
```

```
hide footbox
```

```
projectscale monthly
Project starts the 20th of september 2020
[Prototype design] as [TASK1] lasts 130 days
[TASK1] is colored in Lavender/LightBlue
[Testing] lasts 20 days
[TASK1]->[Testing]
```

```
2021-01-18 to 2021-01-22 are named [End's committee]
2021-01-18 to 2021-01-22 are colored in salmon
@endgantt
```

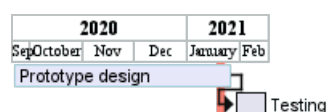

- quarterly scale

```
@startgantt
```



```
hide footbox
```

```
projectscale quarterly
Project starts the 1st of october 2020
[Prototype design] as [TASK1] lasts 700 days
[TASK1] is colored in Lavender/LightBlue
[Testing] lasts 200 days
[TASK1]->[Testing]
```

```
2021-01-18 to 2021-03-22 are colored in salmon
@endganttt
```

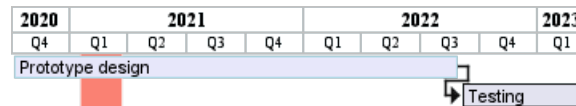

- yearly scale

```
@startganttt
```

```
hide footbox
```

```
projectscale yearly
Project starts the 1st of october 2020
[Prototype design] as [TASK1] lasts 700 days
[TASK1] is colored in Lavender/LightBlue
[Testing] lasts 200 days
[TASK1]->[Testing]
```

```
2021-01-18 to 2021-03-22 are colored in salmon
@endganttt
```

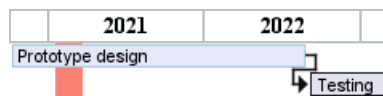

## 16.34 Language of the calendar

You can choose the language of the Gantt calendar, with the `language <xx>` command where `<xx>` is the ISO 639 code of the language.

### 16.34.1 English (*en*, by default)

```
@startganttt
saturday are closed
sunday are closed
```

```
Project starts 2021-01-01
[Prototype design end] as [TASK1] lasts 19 days
[TASK1] is colored in Lavender/LightBlue
[Testing] lasts 14 days
[TASK1]->[Testing]
```

```
2021-01-18 to 2021-01-22 are colored in salmon
@endganttt
```



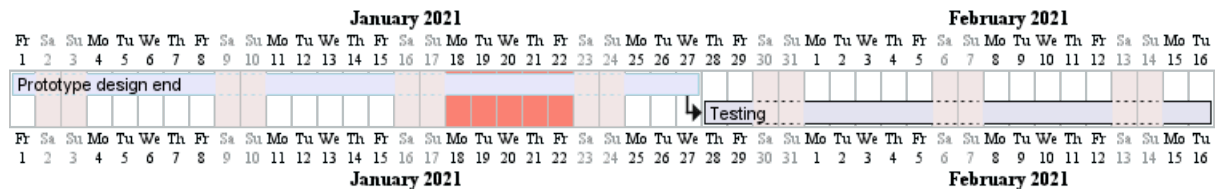

### 16.34.2 Deutsch (de)

```
@startgantt
language de
saturday are closed
sunday are closed
```

```
Project starts 2021-01-01
[Prototype design end] as [TASK1] lasts 19 days
[TASK1] is colored in Lavender/LightBlue
[Testing] lasts 14 days
[TASK1]->[Testing]
```

```
2021-01-18 to 2021-01-22 are colored in salmon
@endgantt
```

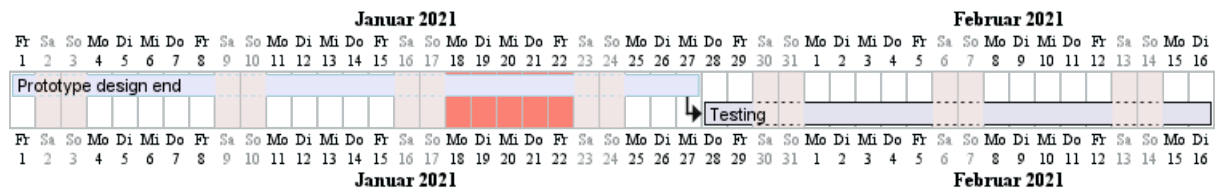

### 16.34.3 Japanese (ja)

```
@startgantt
language ja
saturday are closed
sunday are closed
```

```
Project starts 2021-01-01
[Prototype design end] as [TASK1] lasts 19 days
[TASK1] is colored in Lavender/LightBlue
[Testing] lasts 14 days
[TASK1]->[Testing]
```

```
2021-01-18 to 2021-01-22 are colored in salmon
@endgantt
```



### 16.34.4 Chinese (zh)

```
@startgantt
language zh
saturday are closed
sunday are closed
```



```
Project starts 2021-01-01
[Prototype design end] as [TASK1] lasts 19 days
[TASK1] is colored in Lavender/LightBlue
[Testing] lasts 14 days
[TASK1]->[Testing]
```

```
2021-01-18 to 2021-01-22 are colored in salmon
@endgantt
```

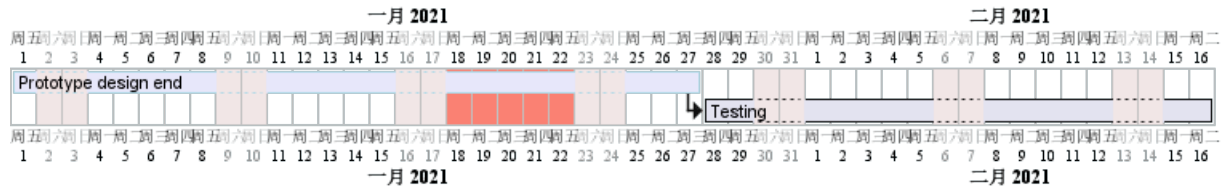

### 16.34.5 Korean (ko)

```
@startgantt
language ko
saturday are closed
sunday are closed
```

```
Project starts 2021-01-01
[Prototype design end] as [TASK1] lasts 19 days
[TASK1] is colored in Lavender/LightBlue
[Testing] lasts 14 days
[TASK1]->[Testing]
```

```
2021-01-18 to 2021-01-22 are colored in salmon
@endgantt
```

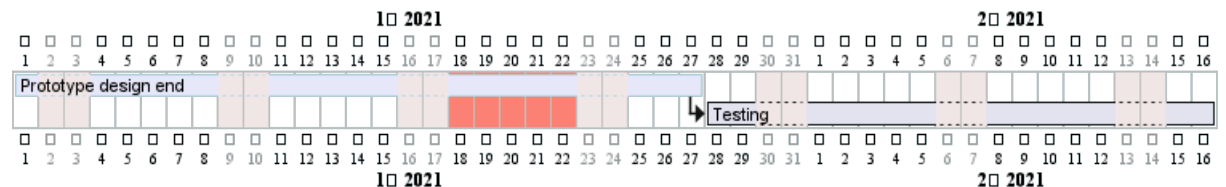

## 16.35 Delete Tasks or Milestones

You can mark some Tasks or Milestones as `deleted` instead of normally completed to distinguish tasks that may possibly have been discarded, postponed or whatever.

```
@startgantt
[Prototype design] lasts 1 weeks
then [Prototype completed] lasts 4 days
[End Prototype completed] happens at [Prototype completed]'s end
then [Test prototype] lasts 5 days
[End Test prototype] happens at [Test prototype]'s end

[Prototype completed] is deleted
[End Prototype completed] is deleted
@endgantt
```

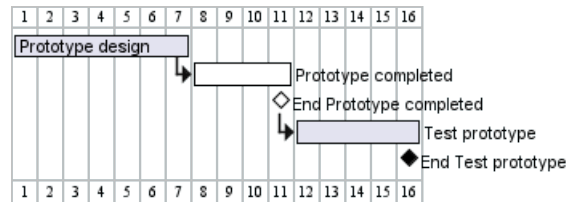

[Ref. QA-9129]

## 16.36 Start a project, a task or a milestone a number of days before or after today

You can start a project, a task or a milestone a number of days before or after today, using the builtin functions `%now` and `%date`:

```
@startgantt
title Today is %date("YYYY-MM-dd")
!$now = %now()
!$past = %date("YYYY-MM-dd", $now - 14*24*3600)
Project starts $past
today is colored in pink
[foo] lasts 10 days
[bar] lasts 5 days and starts %date("YYYY-MM-dd", $now + 4*24*3600)
[Tomorrow] happens %date("YYYY-MM-dd", $now + 1*24*3600)
@endgantt
```

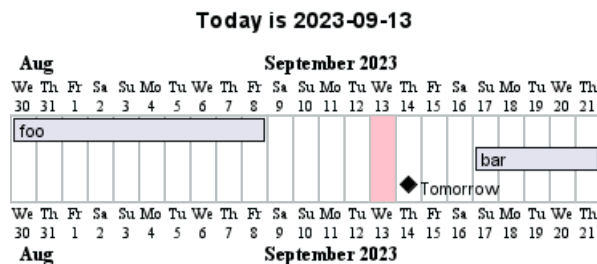

[Ref. QA-16285]

## 16.37 Change Label position

### 16.37.1 The labels are near elements (*by default*)

```
@startgantt
[Task1] lasts 1 days
then [Task2_long_long] as [T2] lasts 2 days
-- Phase Two --
then [Task3] as [T3] lasts 2 days
[Task4] as [T4] lasts 1 day
[Task5] as [T5] lasts 2 days
[T2] -> [T4]
[T2] -> [T5]
[Task6_long_long] as [T6] lasts 4 days
[T3] -> [T6]
[T5] -> [T6]
[End] happens 1 day after [T6]'s end
@endgantt
```





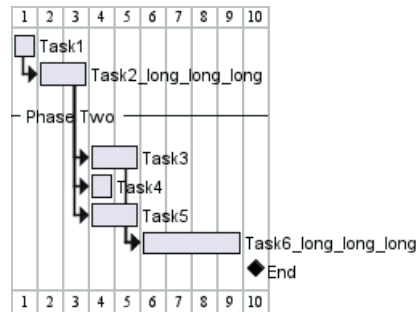

To change the label position, you can use the command `label`:

### 16.37.2 Label on first column

- Left aligned

```
@startgantt
Label on first column and left aligned
[Task1] lasts 1 days
then [Task2_long_long_long] as [T2] lasts 2 days
-- Phase Two --
then [Task3] as [T3] lasts 2 days
[Task4] as [T4] lasts 1 day
[Task5] as [T5] lasts 2 days
[T2] -> [T4]
[T2] -> [T5]
[Task6_long_long_long] as [T6] lasts 4 days
[T3] -> [T6]
[T5] -> [T6]
[End] happens 1 day after [T6]'s end
@endgantt
```

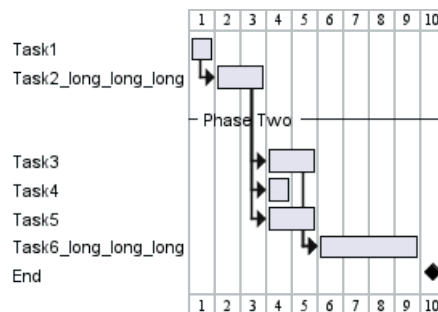

- Right aligned

```
@startgantt
Label on first column and right aligned
[Task1] lasts 1 days
then [Task2_long_long_long] as [T2] lasts 2 days
-- Phase Two --
then [Task3] as [T3] lasts 2 days
[Task4] as [T4] lasts 1 day
[Task5] as [T5] lasts 2 days
[T2] -> [T4]
[T2] -> [T5]
[Task6_long_long_long] as [T6] lasts 4 days
[T3] -> [T6]
[T5] -> [T6]
[End] happens 1 day after [T6]'s end
@endgantt
```





### 16.37.3 Label on last column

- Left aligned

```
@startgantt
Label on last column and left aligned
[Task1] lasts 1 days
then [Task2_long_long_long] as [T2] lasts 2 days
-- Phase Two --
then [Task3] as [T3] lasts 2 days
[Task4] as [T4] lasts 1 day
[Task5] as [T5] lasts 2 days
[T2] -> [T4]
[T2] -> [T5]
[Task6_long_long_long] as [T6] lasts 4 days
[T3] -> [T6]
[T5] -> [T6]
[End] happens 1 day after [T6]'s end
@endgantt
```

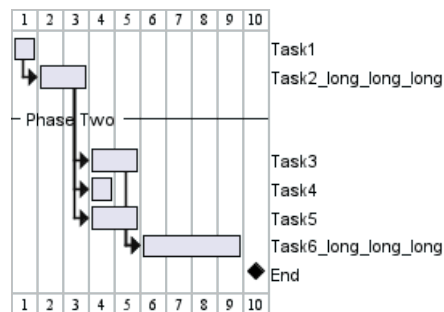

- Right aligned

```
@startgantt
Label on last column and right aligned
[Task1] lasts 1 days
then [Task2_long_long_long] as [T2] lasts 2 days
-- Phase Two --
then [Task3] as [T3] lasts 2 days
[Task4] as [T4] lasts 1 day
[Task5] as [T5] lasts 2 days
[T2] -> [T4]
[T2] -> [T5]
[Task6_long_long_long] as [T6] lasts 4 days
[T3] -> [T6]
[T5] -> [T6]
[End] happens 1 day after [T6]'s end
@endgantt
```





[Ref. QA-12433]

## 17 MindMap

MindMap diagram are still in beta: the syntax may change without notice.

### 17.1 OrgMode syntax

This syntax is compatible with OrgMode

```
@startmindmap
* Debian
** Ubuntu
*** Linux Mint
*** Kubuntu
*** Lubuntu
*** KDE Neon
** LMDE
** SolydXK
** SteamOS
** Raspbian with a very long name
*** <s>Raspmbc</s> => OSMC
*** <s>Raspyfi</s> => Volumio
@endmindmap
```

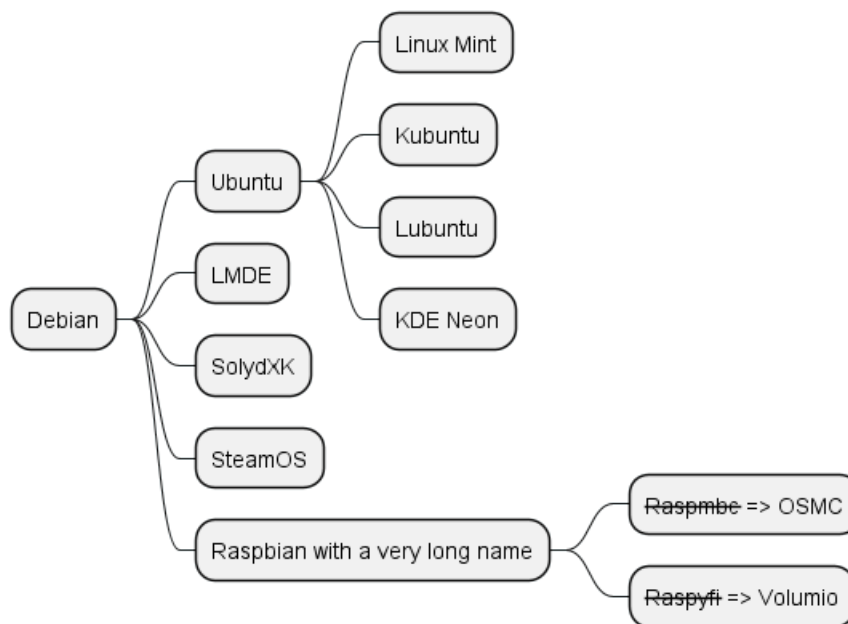

### 17.2 Markdown syntax

This syntax is compatible with Markdown

```
@startmindmap
* root node
* some first level node
* second level node
* another second level node
* another first level node
@endmindmap
```



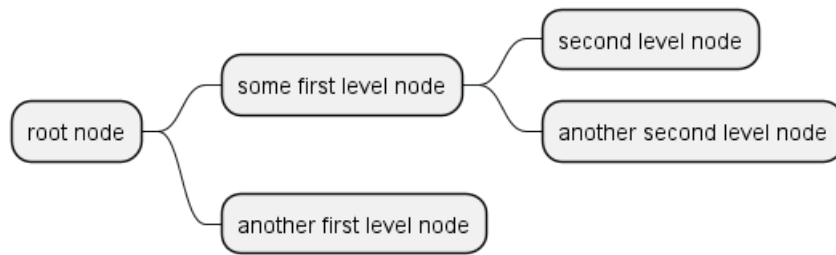

### 17.3 Arithmetic notation

You can use the following notation to choose diagram side.

```

@startmindmap
+ OS
++ Ubuntu
+++ Linux Mint
+++ Kubuntu
+++ Lubuntu
+++ KDE Neon
++ LMDE
++ SolydXK
++ SteamOS
++ Raspbian
-- Windows 95
-- Windows 98
-- Windows NT
--- Windows 8
--- Windows 10
@endmindmap
  
```

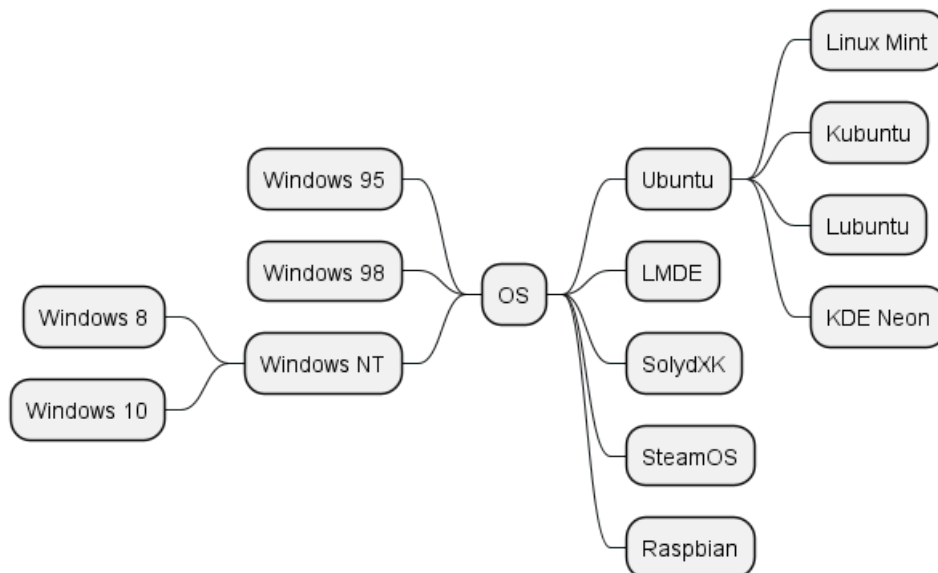

### 17.4 Multilines

You can use : and ; to have multilines box.

```

@startmindmap
* Class Templates
  
```



```

**:Example 1
<code>
template <typename T>
class cname{
void f1()<U+003B>
...
}
</code>
;
**:Example 2
<code>
other template <typename T>
class cname{
...
</code>
;
@endmindmap

```

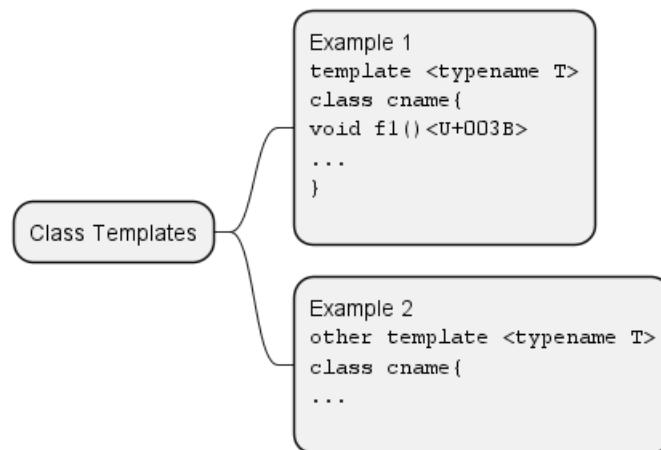

```

@startmindmap
+ root
**:right_1.1
right_1.2;
++ right_2

left side

-- left_1
-- left_2
**:left_3.1
left_3.2;
@endmindmap

```

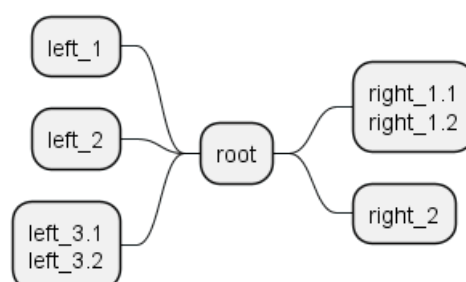

## 17.5 Multiroot Mindmap

You can create multiroot mindmap, as:

```
@startmindmap
* Root 1
** Foo
** Bar
* Root 2
** Lorem
** Ipsum
@endmindmap
```

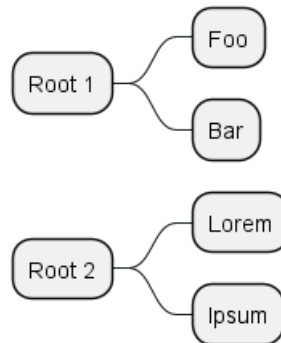

[Ref. QH-773]

## 17.6 Colors

It is possible to change node color.

### 17.6.1 With inline color

- OrgMode syntax mindmap

```
@startmindmap
* [#Orange] Colors
** [#lightgreen] Green
** [#FFBCC] Rose
** [#lightblue] Blue
@endmindmap
```

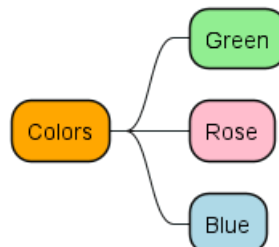

- Arithmetic notation syntax mindmap

```
@startmindmap
+ [#Orange] Colors
++ [#lightgreen] Green
++ [#FFBCC] Rose
-- [#lightblue] Blue
@endmindmap
```



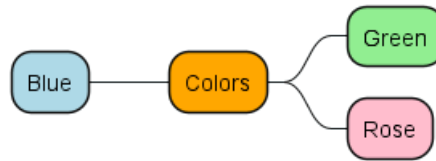

- Markdown syntax mindmap

```

@startmindmap
* [#Orange] root node
  * [#lightgreen] some first level node
    * [#FFBBCC] second level node
    * [#lightblue] another second level node
  * [#lightgreen] another first level node
@endmindmap
  
```

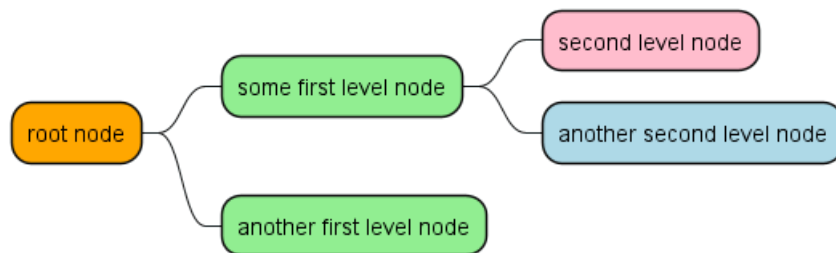

### 17.6.2 With style color

- OrgMode syntax mindmap

```

@startmindmap
<style>
mindmapDiagram {
  .green {
    BackgroundColor lightgreen
  }
  .rose {
    BackgroundColor #FFBBCC
  }
  .your_style_name {
    BackgroundColor lightblue
  }
}
</style>
* Colors
** Green <<green>>
** Rose <<rose>>
** Blue <<your_style_name>>
@endmindmap
  
```





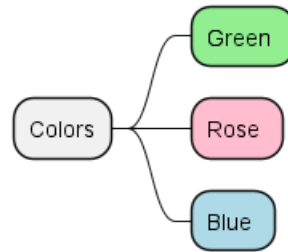

- Arithmetic notation syntax mindmap

```

@startmindmap
<style>
mindmapDiagram {
  .green {
    BackgroundColor lightgreen
  }
  .rose {
    BackgroundColor #FFBCC
  }
  .your_style_name {
    BackgroundColor lightblue
  }
}
</style>
+ Colors
++ Green <<green>>
++ Rose <<rose>>
-- Blue <<your_style_name>>
@endmindmap
  
```

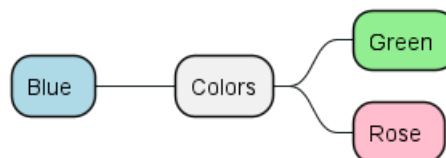

- Markdown syntax mindmap

```

@startmindmap
<style>
mindmapDiagram {
  .green {
    BackgroundColor lightgreen
  }
  .rose {
    BackgroundColor #FFBCC
  }
  .your_style_name {
    BackgroundColor lightblue
  }
}
</style>
* root node
* some first level node <<green>>
* second level node <<rose>>
* another second level node <<your_style_name>>
  
```

```
* another first level node <<green>>
@endmindmap
```

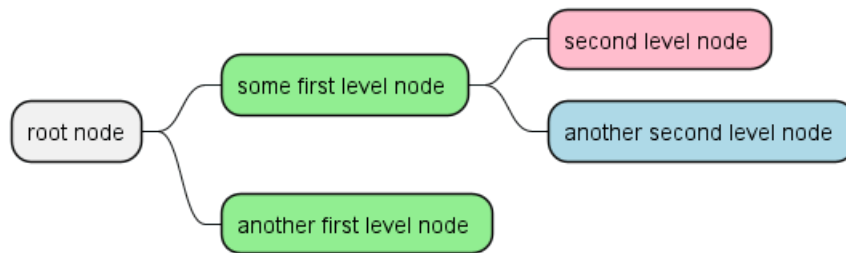

- Apply style to a branch

```
@startmindmap
<style>
mindmapDiagram {
  .myStyle * {
    BackgroundColor lightgreen
  }
}
</style>
+ root
++ b1 <<myStyle>>
+++ b11
+++ b12
++ b2
@endmindmap
```

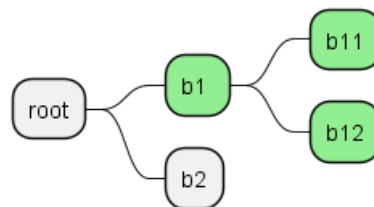

[Ref. GA-920]

## 17.7 Removing box

You can remove the box drawing using an underscore.

```
@startmindmap
* root node
** some first level node
***_ second level node
***_ another second level node
***_ foo
***_ bar
***_ foobar
** another first level node
@endmindmap
```



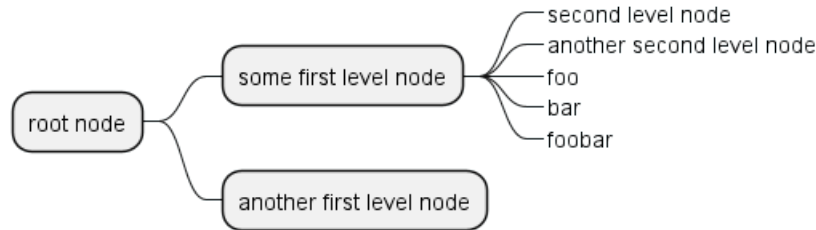

```

@startmindmap
*_ root node
**_ some first level node
***_ second level node
***_ another second level node
***_ foo
***_ bar
***_ foobar
**_ another first level node
@endmindmap
  
```

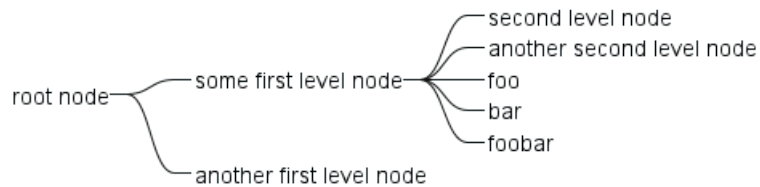

```

@startmindmap
+ root node
++ some first level node
+++_ second level node
+++_ another second level node
+++_ foo
+++_ bar
+++_ foobar
++_ another first level node
-- some first right level node
--_ another first right level node
@endmindmap
  
```

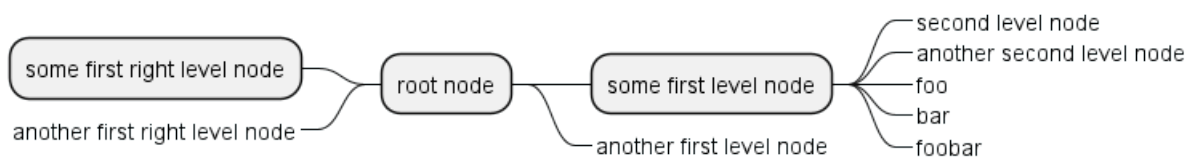

## 17.8 Changing diagram direction

It is possible to use both sides of the diagram.

```

@startmindmap
* count
** 100
*** 101
*** 102
** 200
  
```



left side

```

** A
*** AA
*** AB
** B
@endmindmap

```

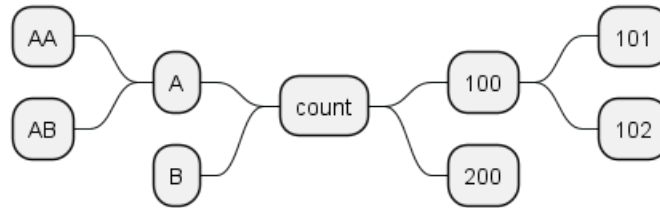

## 17.9 Complete example

```

@startmindmap
caption figure 1
title My super title

* <&flag>Debian
** <&globe>Ubuntu
*** Linux Mint
*** Kubuntu
*** Lubuntu
*** KDE Neon
** <&graph>LMDE
** <&pulse>SolydXX
** <&people>SteamOS
** <&star>Raspbian with a very long name
*** <s>Raspmbc</s> => OSMC
*** <s>Raspyfi</s> => Volumio

header
My super header
endheader

center footer My super footer

legend right
Short
legend
endlegend
@endmindmap

```

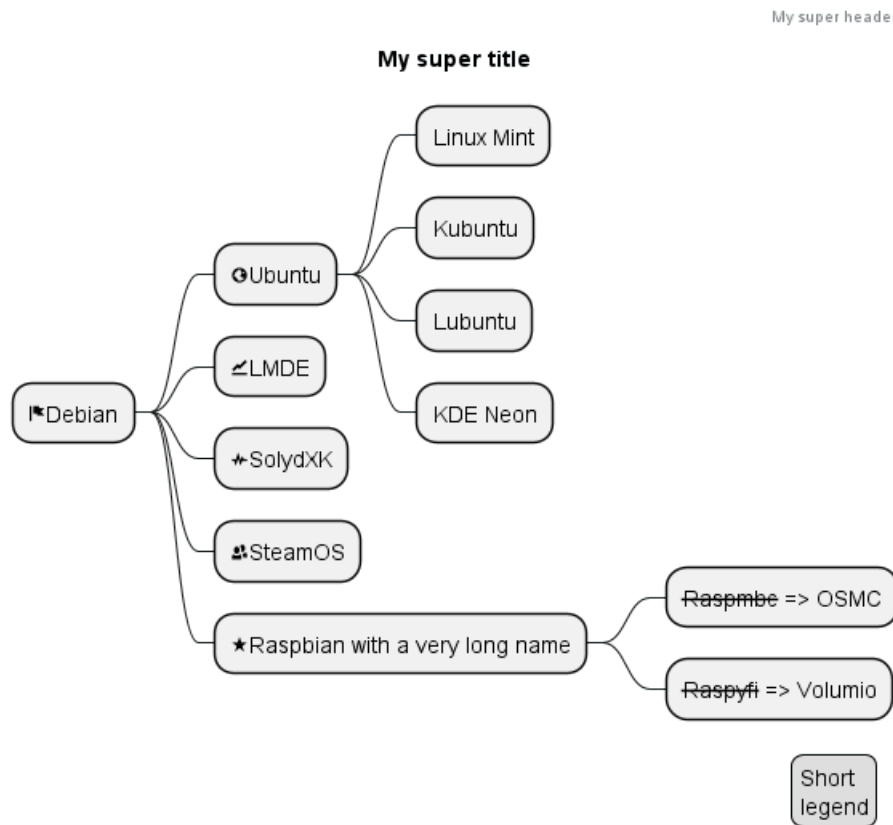

figure 1  
My super footer

## 17.10 Changing style

### 17.10.1 node, depth

```

@startmindmap
<style>
mindmapDiagram {
  node {
    BackgroundColor lightGreen
  }
  :depth(1) {
    BackGroundColor white
  }
}
</style>
* Linux
** NixOS
** Debian
*** Ubuntu
**** Linux Mint
**** Kubuntu
**** Lubuntu
**** KDE Neon
@endmindmap
  
```

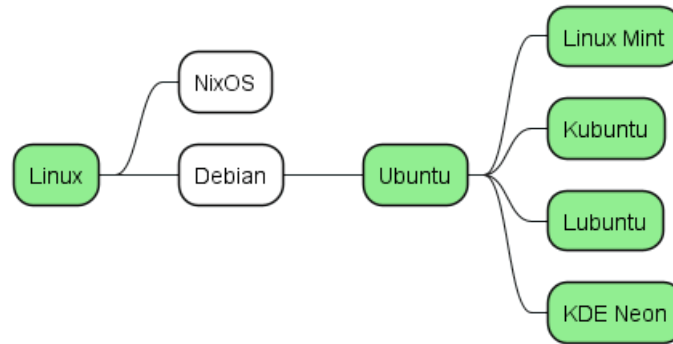

### 17.10.2 boxless

```

@startmindmap
<style>
mindmapDiagram {
  node {
    BackgroundColor lightGreen
  }
  boxless {
    FontColor darkgreen
  }
}
</style>
* Linux
** NixOS
** Debian
***_ Ubuntu
**** Linux Mint
**** Kubuntu
**** Lubuntu
**** KDE Neon
@endmindmap
  
```

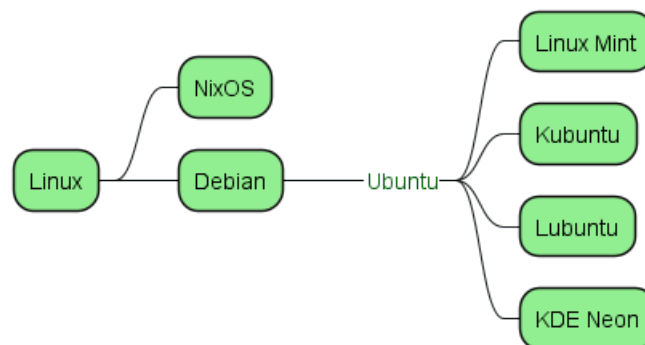

## 17.11 Word Wrap

Using `MaximumWidth` setting you can control automatic word wrap. Unit used is pixel.

```
@startmindmap
```

```
<style>
node {
```



```

    Padding 12
    Margin 3
    HorizontalAlignment center
    LineColor blue
    LineThickness 3.0
    BackgroundColor gold
    RoundCorner 40
    MaximumWidth 100
}

rootNode {
    LineStyle 8.0;3.0
    LineColor red
    BackgroundColor white
    LineThickness 1.0
    RoundCorner 0
    Shadowing 0.0
}

leafNode {
    LineColor gold
    RoundCorner 0
    Padding 3
}

arrow {
    LineStyle 4
    LineThickness 0.5
    LineColor green
}
</style>

* Hi =)
** sometimes i have node in wich i want to write a long text
*** this results in really huge diagram
**** of course, i can explicit split with a\nnew line
**** but it could be cool if PlantUML was able to split long lines, maybe with an option

@endmindmap

```

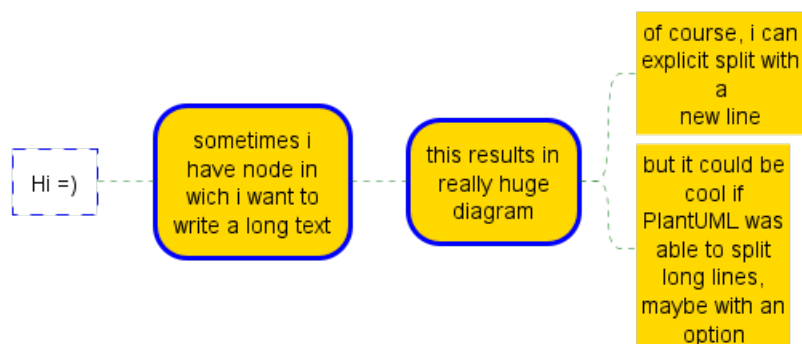

## 17.12 Creole on Mindmap diagram

You can use Creole or HTML Creole on Mindmap:

```

@startmindmap
* Creole on Mindmap

```



```

left side
**::=Creole
  This is bold
  This is italics
  This is "monospaced"
  This is stricken-out
  This is underlined
  This is wave-underlined
--test Unicode and icons--
  This is <U+221E> long
  This is a <&code> icon
  Use image : <img:http://plantuml.com/logo3.png>
;
**: <b>HTML Creole
  This is <b>bold</b>
  This is <i>italics</i>
  This is <font:monospaced>monospaced</font>
  This is <s>stoked</s>
  This is <u>underlined</u>
  This is <w>waved</w>
  This is <s:green>stoked</s>
  This is <u:red>underlined</u>
  This is <w:#0000FF>waved</w>
-- other examples --
  This is <color:blue>Blue</color>
  This is <back:orange>Orange background</back>
  This is <size:20>big</size>
;
right side
**::=Creole line
You can have horizontal line
----
Or double line
====
Or strong line
----
Or dotted line
..My title..
Or dotted title
//and title... //
==Title==
Or double-line title
--Another title--
Or single-line title
Enjoy!;
**::=Creole list item
**test list 1**
* Bullet list
* Second item
** Sub item
*** Sub sub item
* Third item
----
**test list 2**
# Numbered list
# Second item
## Sub item
## Another sub item

```





```
# Third item
;
@endmindmap
```

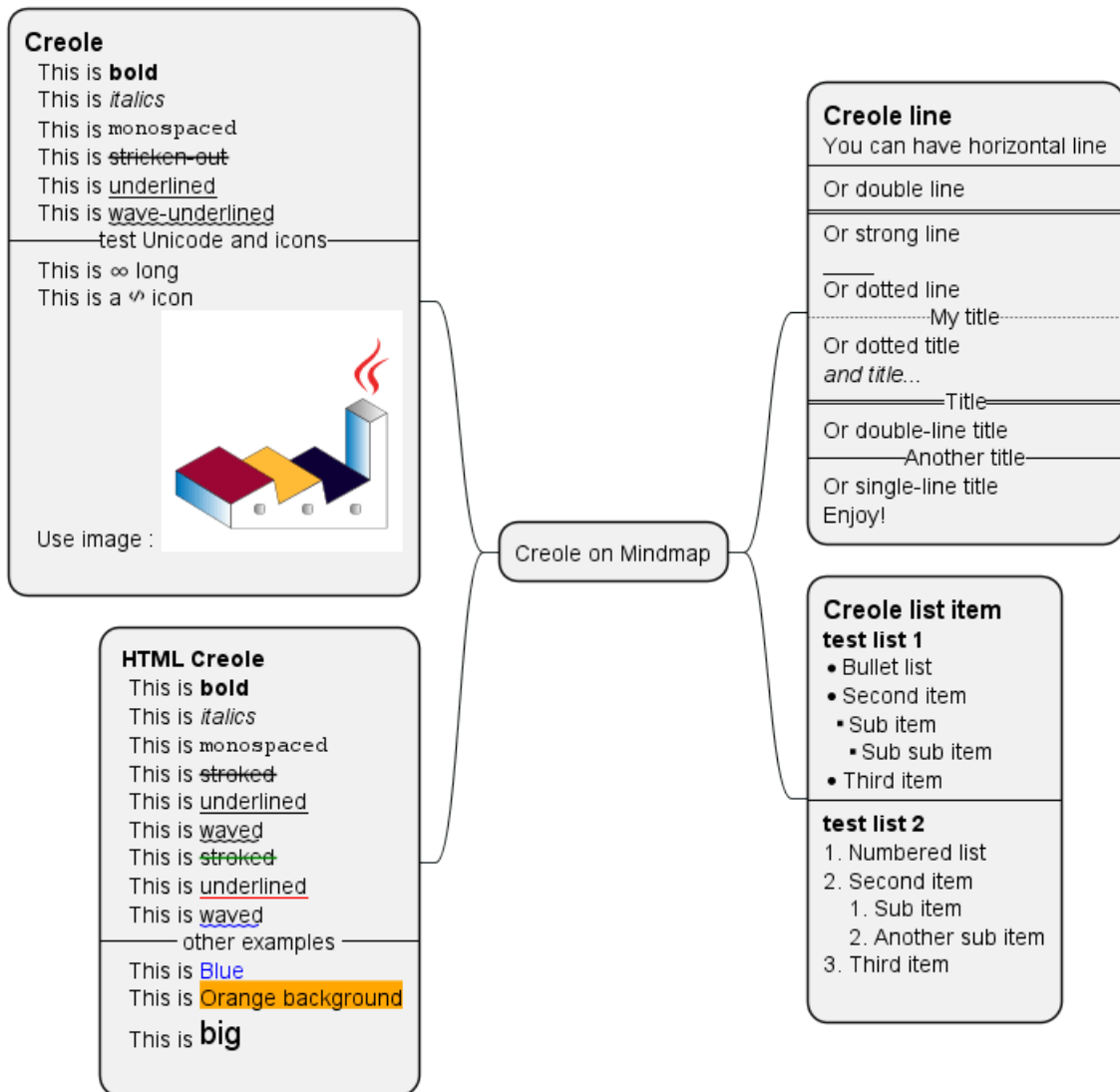

[Ref. QA-17838]

## 18 Work Breakdown Structure (WBS)

WBS diagram are still in beta: the syntax may change without notice.

### 18.1 OrgMode syntax

This syntax is compatible with OrgMode

```
@startwbs
* Business Process Modelling WBS
** Launch the project
*** Complete Stakeholder Research
*** Initial Implementation Plan
** Design phase
*** Model of AsIs Processes Completed
**** Model of AsIs Processes Completed1
**** Model of AsIs Processes Completed2
*** Measure AsIs performance metrics
*** Identify Quick Wins
** Complete innovate phase
@endwbs
```

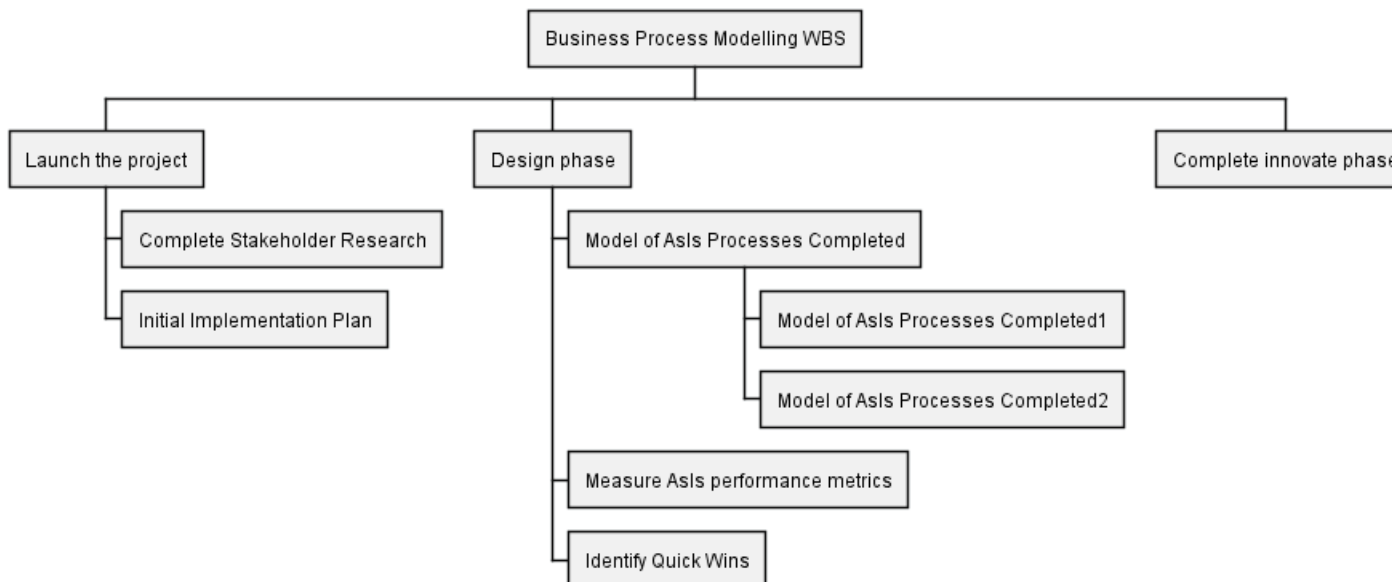

### 18.2 Change direction

You can change direction using < and >

```
@startwbs
* Business Process Modelling WBS
** Launch the project
*** Complete Stakeholder Research
*** Initial Implementation Plan
** Design phase
*** Model of AsIs Processes Completed
****< Model of AsIs Processes Completed1
****> Model of AsIs Processes Completed2
***< Measure AsIs performance metrics
***< Identify Quick Wins
@endwbs
```



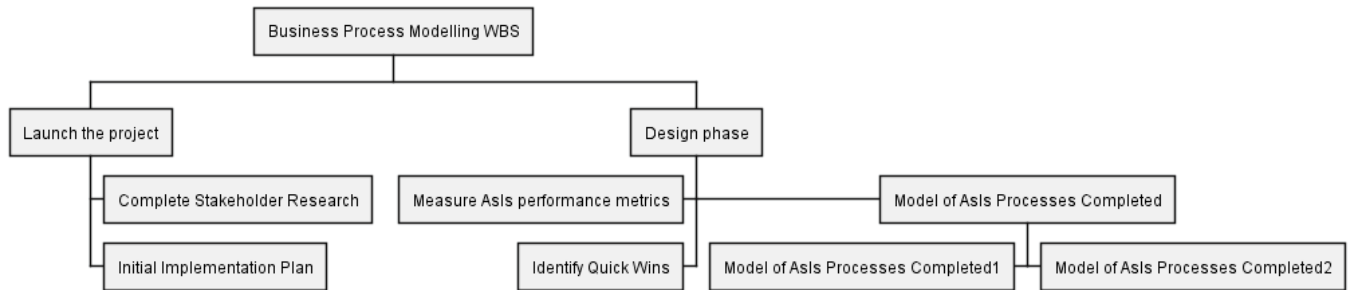

### 18.3 Arithmetic notation

You can use the following notation to choose diagram side.

```

@startwbs
+ New Job
++ Decide on Job Requirements
+++ Identity gaps
+++ Review JDs
++++ Sign-Up for courses
++++ Volunteer
++++ Reading
+- Checklist
+++- Responsibilities
+++- Location
++ CV Upload Done
+++ CV Updated
++++ Spelling & Grammar
++++ Check dates
---- Skills
+++ Recruitment sites chosen
@endwbs
    
```

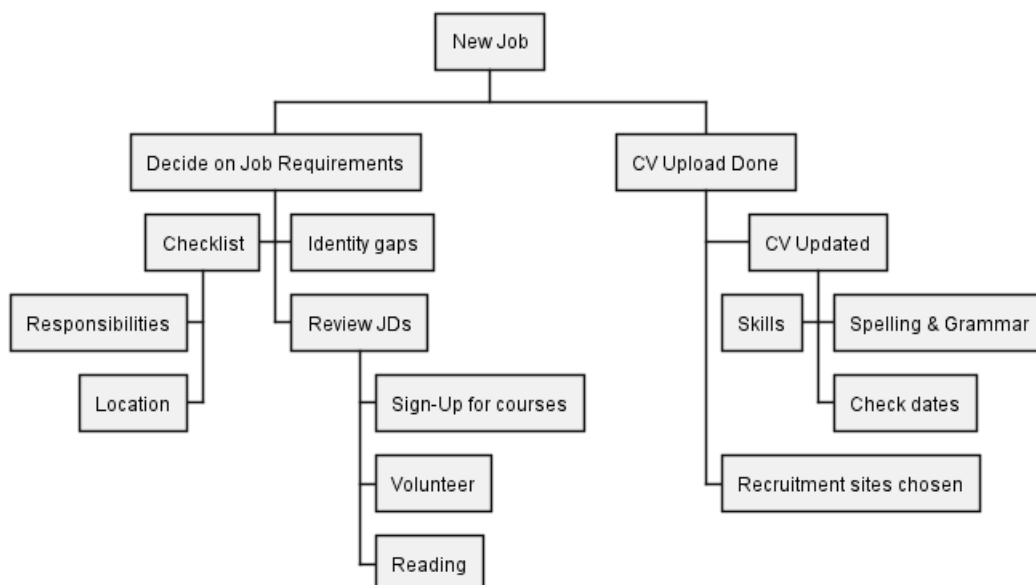

### 18.4 Multilines

You can use : and ; to have multilines box, as on MindMap.

```

@startwbs
    
```

```

* <&flag> Debian
** <&globe> Ubuntu

***:Linux Mint
Open Source;

*** Kubuntu
*** ...
@endwbs

```

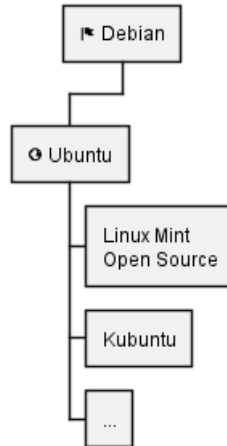

[Ref. QA-13945]

## 18.5 Removing box

You can use underscore `_` to remove box drawing.

### 18.5.1 Boxless on Arithmetic notation

### 18.5.2 Several boxless node

```

@startwbs
+ Project
+ Part One
+ Task 1.1
- LeftTask 1.2
+ Task 1.3
+ Part Two
+ Task 2.1
+ Task 2.2
- _ Task 2.2.1 To the left boxless
- _ Task 2.2.2 To the Left boxless
+ _ Task 2.2.3 To the right boxless
@endwbs

```



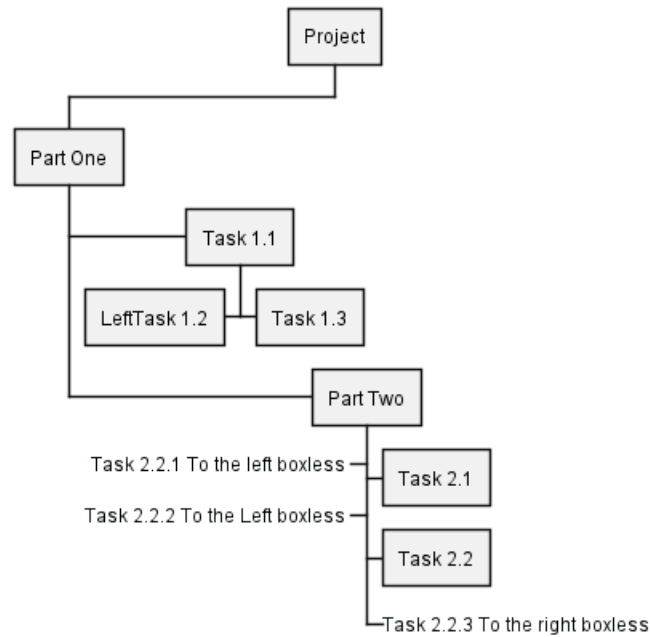

### 18.5.3 All boxless node

```

@startwbs
+_ Project
+_ Part One
  +_ Task 1.1
  -_ LeftTask 1.2
  +_ Task 1.3
+_ Part Two
  +_ Task 2.1
  +_ Task 2.2
  -_ Task 2.2.1 To the left boxless
  -_ Task 2.2.2 To the Left boxless
  +_ Task 2.2.3 To the right boxless
@endwbs
  
```

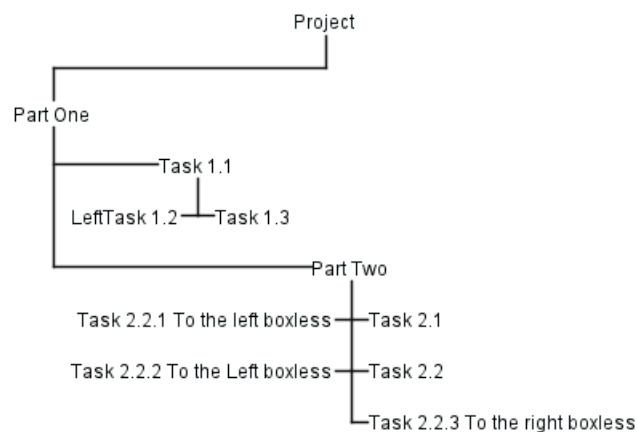

### 18.5.4 Boxless on OrgMode syntax

### 18.5.5 Several boxless node

```

@startwbs
* World
** America
  
```



```

***_ Canada
***_ Mexico
***_ USA
** Europe
***_ England
***_ Germany
***_ Spain
@endwbs

```

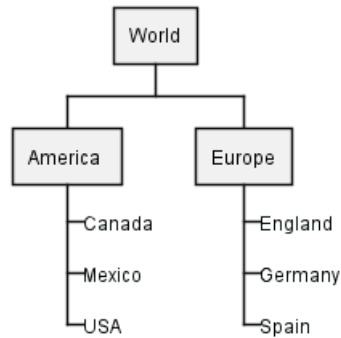

[Ref. QA-13297]

#### 18.5.6 All boxless node

```

@startwbs
*_ World
**_ America
***_ Canada
***_ Mexico
***_ USA
**_ Europe
***_ England
***_ Germany
***_ Spain
@endwbs

```

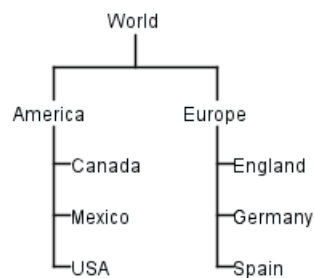

[Ref. QA-13355]

## 18.6 Colors (with inline or style color)

It is possible to change node color:

- with inline color

```

@startwbs
* [#SkyBlue] this is the partner workpackage
** [#pink] this is my workpackage
** this is another workpackage
@endwbs

```



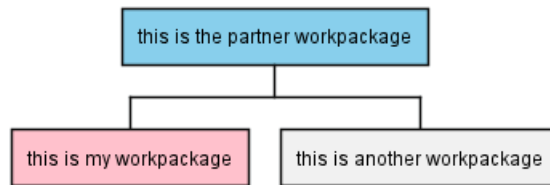

```

@startwbs
+[#SkyBlue] this is the partner workpackage
++[#pink] this is my workpackage
++ this is another workpackage
@endwbs
  
```

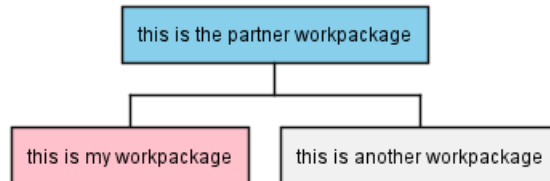

[Ref. QA-12374, only from v1.2020.20]

- with style color

```

@startwbs
<style>
wbsDiagram {
  .pink {
    BackgroundColor pink
  }
  .your_style_name {
    BackgroundColor SkyBlue
  }
}
</style>
* this is the partner workpackage <<your_style_name>>
** this is my workpackage <<pink>>
** this is another workpackage
@endwbs
  
```

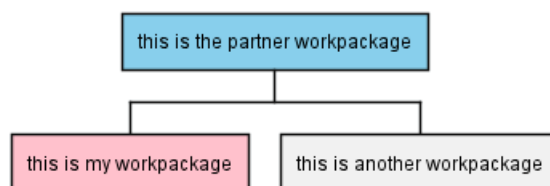

```

@startwbs
<style>
wbsDiagram {
  .pink {
    BackgroundColor pink
  }
  .your_style_name {
    BackgroundColor SkyBlue
  }
}
</style>
+ this is the partner workpackage <<your_style_name>>
++ this is my workpackage <<pink>>
  
```



```

++ this is another workpackage
@endwbs

```

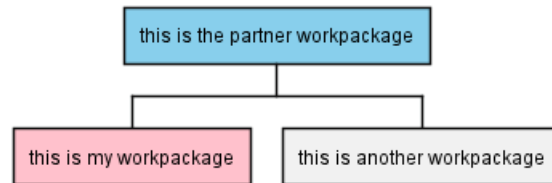

## 18.7 Using style

It is possible to change diagram style.

```

@startwbs
<style>
wbsDiagram {
  // all lines (meaning connector and borders, there are no other lines in WBS) are black by default
  LineColor black
  arrow {
    // note that connector are actually "arrow" even if they don't look like as arrow
    // This is to be consistent with other UML diagrams. Not 100% sure that it's a good idea
    // So now connector are green
    LineColor green
  }
  :depth(0) {
    // will target root node
    BackgroundColor White
    RoundCorner 10
    LineColor red
    // Because we are targetting depth(0) for everything, border and connector for level 0 will be
  }
  arrow {
    :depth(2) {
      // Targetting only connector between Mexico-Chihuahua and USA-Texas
      LineColor blue
     LineStyle 4
      LineThickness .5
    }
  }
  node {
    :depth(2) {
     LineStyle 2
      LineThickness 2.5
    }
  }
  boxless {
    // will target boxless node with '_'
    FontColor darkgreen
  }
}
</style>
* World
** America
*** Canada
*** Mexico
**** Chihuahua
*** USA
**** Texas

```





```

***< New York
** Europe
***_ England
***_ Germany
***_ Spain
@endwbs

```

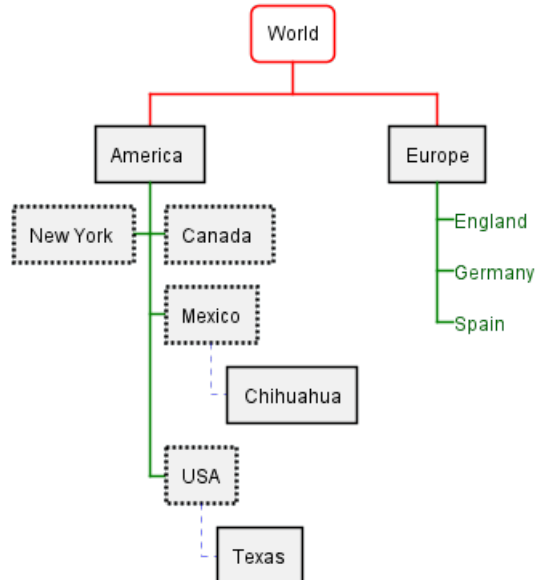

## 18.8 Word Wrap

Using `MaximumWidth` setting you can control automatic word wrap. Unit used is pixel.

```
@startwbs
```

```

<style>
node {
    Padding 12
    Margin 3
    HorizontalAlignment center
    LineColor blue
    LineThickness 3.0
    BackgroundColor gold
    RoundCorner 20
    MaximumWidth 100
}

rootNode {
   LineStyle 8.0;3.0
    LineColor red
    BackgroundColor white
    LineThickness 1.0
    RoundCorner 0
    Shadowing 0.0
}

leafNode {
    LineColor gold
    RoundCorner 0
    Padding 3

```



```

}

arrow {
  LineStyle 4
  LineThickness 0.5
  LineColor green
}
</style>

* Hi =)
** sometimes i have node in wich i want to write a long text
*** this results in really huge diagram
**** of course, i can explicit split with a\nnew line
**** but it could be cool if PlantUML was able to split long lines, maybe with an option who specify

@endwbs

```

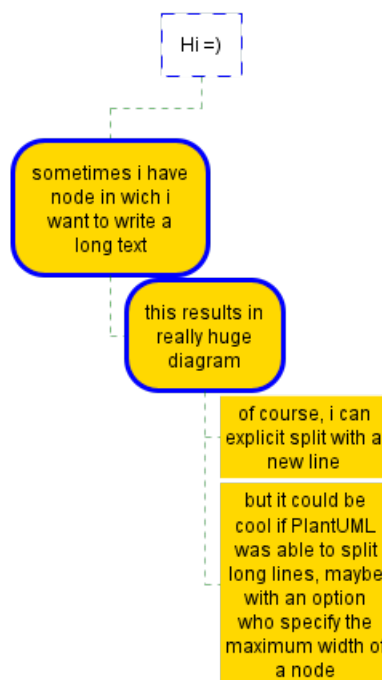

## 18.9 Add arrows between WBS elements

You can add arrows between WBS elements.

Using alias with as:

```

@startwbs
<style>
.foo {
  LineColor #00FF00;
}
</style>
* Test
** A topic
*** "common" as c1
*** "common2" as c2
** "Another topic" as t2
t2 -> c1 <<foo>>
t2 ..> c2 #blue
@endwbs

```



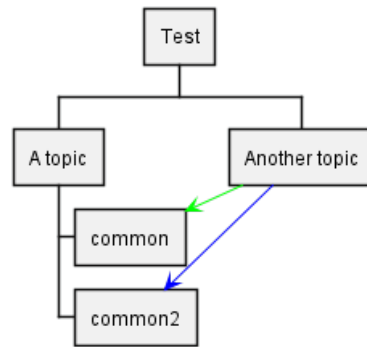

Using alias in parentheses:

```

@startwbs
* Test
**(b) A topic
**(c1) common
**(t2) Another topic
t2 --> c1
b -> t2 #blue
@endwbs
  
```

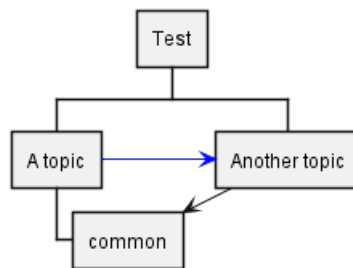

[Ref. QA-16251]

## 18.10 Creole on WBS diagram

You can use Creole or HTML Creole on WBS:

```

@startwbs
* Creole on WBS
**::=Creole
  This is bold
  This is italics
  This is "monospaced"
  This is stricken-out
  This is underlined
  This is wave-underlined
--test Unicode and icons--
  This is long
  This is a code icon
  Use image : 
;
**: <b>HTML Creole
  This is <b>bold</b>
  This is <i>italics</i>
  This is <font:monospaced>monospaced</font>
  This is <s>stroked</s>
  This is <u>underlined</u>
  This is <w>waved</w>
  
```



```

This is <s:green>stroked</s>
This is <u:red>underlined</u>
This is <w:#0000FF>waved</w>
-- other examples --
This is <color:blue>Blue</color>
This is <back:orange>Orange background</back>
This is <size:20>big</size>
;
**::=Creole line
You can have horizontal line
----
Or double line
=====
Or strong line
-----
Or dotted line
..My title..
Or dotted title
//and title... //
==Title==
Or double-line title
--Another title--
Or single-line title
Enjoy!;
**::=Creole list item
**test list 1**
* Bullet list
* Second item
** Sub item
*** Sub sub item
* Third item
----
**test list 2**
# Numbered list
# Second item
## Sub item
## Another sub item
# Third item
;
@endwbs

```

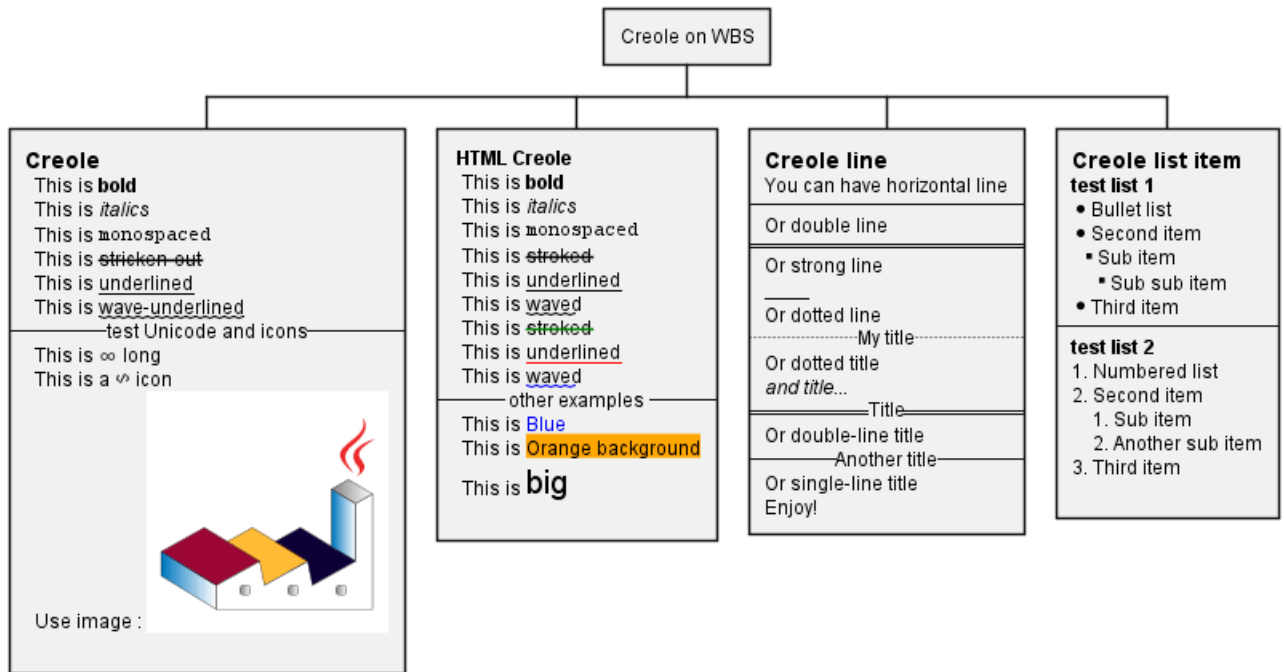

## 19 Maths

Within PlantUML, you can use AsciiMath notation:

```
@startuml
:<math>int_0^1f(x)dx</math>;
:<math>x^2+y_1+z_12^34</math>;
note right
Try also
<math>d/dxf(x)=lim_(h->0)(f(x+h)-f(x))/h</math>
<math>P(y|bb"x") or f(bb"x")+epsilon</math>
end note
@enduml
```

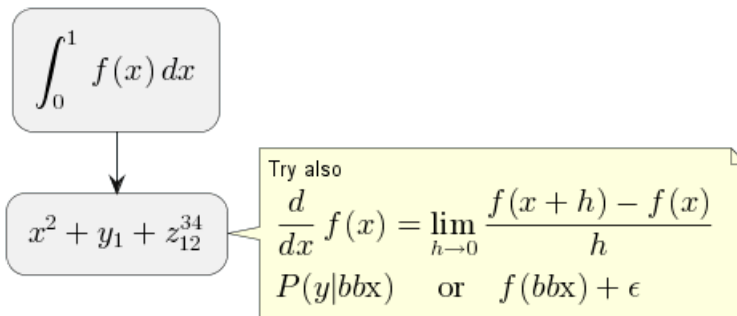

or JLaTeXMath notation:

```
@startuml
:<latex>\int_0^1f(x)dx</latex>;
:<latex>x^2+y_1+z_{12}^{34}</latex>;
note right
Try also
<latex>\frac{d}{dx}f(x)=\lim\limits_{h \to 0}\frac{f(x+h)-f(x)}{h}</latex>
<latex>P(y|\mathbf{x}) \mbox{ or } f(\mathbf{x})+\epsilon</latex>
end note
@enduml
```

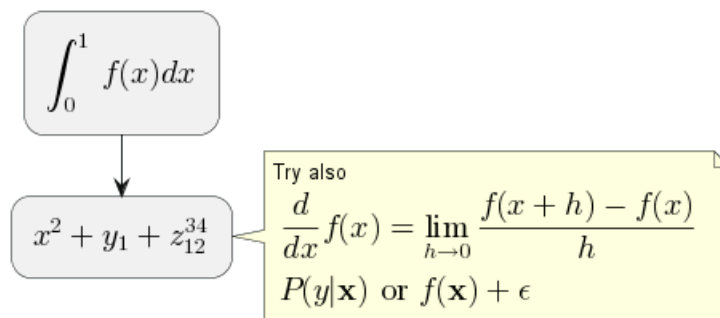

Here is another example:

```
@startuml
Bob -> Alice : Can you solve: <math>ax^2+bx+c=0</math>
Alice --> Bob: <math>x = (-b+-sqrt(b^2-4ac))/(2a)</math>
@enduml
```



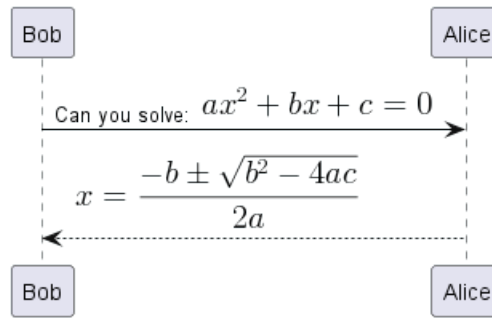

## 19.1 Standalone diagram

You can also use `@startmath/@endmath` to create standalone AsciiMath formula.

```
@startmath
f(t)=(a_0)/2 + sum_(n=1)^oo a_n cos((n*pi*t)/L)+sum_(n=1)^oo b_n sin((n*pi*t)/L)
@endmath
```

$$f(t) = \frac{a_0}{2} + \sum_{n=1}^{\infty} a_n \cos\left(\frac{n\pi t}{L}\right) + \sum_{n=1}^{\infty} b_n \sin\left(\frac{n\pi t}{L}\right)$$

Or use `@startlatex/@endlatex` to create standalone JLaTeXMath formula.

```
@startlatex
\sum_{i=0}^{n-1} (a_i + b_i^2)
@endlatex
```

$$\sum_{i=0}^{n-1} (a_i + b_i^2)$$

## 19.2 How is this working?

To draw those formulas, PlantUML uses two open source projects:

- AsciiMath that converts AsciiMath notation to LaTeX expression;
- JLatexMath that displays mathematical formulas written in LaTeX. JLaTeXMath is the best Java library to display LaTeX code.

ASCIIMathTeXImg.js is small enough to be integrated into PlantUML standard distribution.

Since JLatexMath is bigger, you have to download it separately, then unzip the 4 jar files (*batik-all-1.7.jar*, *jlatexmath-minimal-1.0.3.jar*, *jlm\_cyrillic.jar* and *jlm\_greek.jar*) in the same folder as PlantUML.jar.



## 20 Entity Relationship Diagram

Based on the Information Engineering notation.

This is an extension to the existing Class Diagram. This extension adds:

- Additional relations for the Information Engineering notation.
- An **entity** alias that maps to the class diagram **class**.
- An additional visibility modifier **\*** to identify mandatory attributes.

Otherwise, the syntax for drawing diagrams is the same as for class diagrams. All other features of class diagrams are also supported.

### 20.1 Information Engineering Relations

Type	Symbol
Zero or One	o--
Exactly One	--
Zero or Many	}o--
One or Many	} --

Examples:

```
@startuml
Entity01 }|..|| Entity02
Entity03 }o..o| Entity04
Entity05 ||--o{ Entity06
Entity07 |o--|| Entity08
@enduml
```

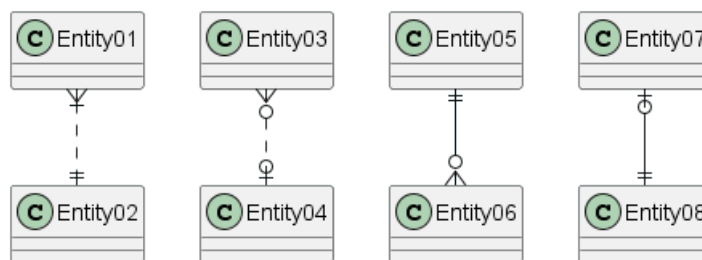

### 20.2 Entities

```
@startuml
entity Entity01 {
  * identifying_attribute
  --
  * mandatory_attribute
  optional_attribute
}
@enduml
```

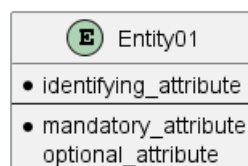

Again, this is the normal class diagram syntax (aside from use of **entity** instead of **class**). Anything that you can do in a class diagram can be done here.





The \* visibility modifier can be used to identify mandatory attributes. A space can be used after the modifier character to avoid conflicts with the creole bold:

```
@startuml
entity Entity01 {
  optional attribute
  **optional bold attribute**
  * **mandatory bold attribute**
}
@enduml
```

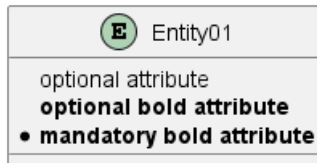

## 20.3 Complete Example

```
@startuml

' hide the spot
' hide circle

' avoid problems with angled crows feet
skinparam linetype ortho

entity "Entity01" as e01 {
  *e1_id : number <<generated>>
  --
  *name : text
  description : text
}

entity "Entity02" as e02 {
  *e2_id : number <<generated>>
  --
  *e1_id : number <<FK>>
  other_details : text
}

entity "Entity03" as e03 {
  *e3_id : number <<generated>>
  --
  e1_id : number <<FK>>
  other_details : text
}

entity "Entity04" as e04 {
  *e4_id : number <<generated>>
  --
  e1_id : number <<FK>>
  other_details : text
}

e01 ||..o{ e02
e01 |o..o{ e03
e01 |o..o{ e04
```



@enduml

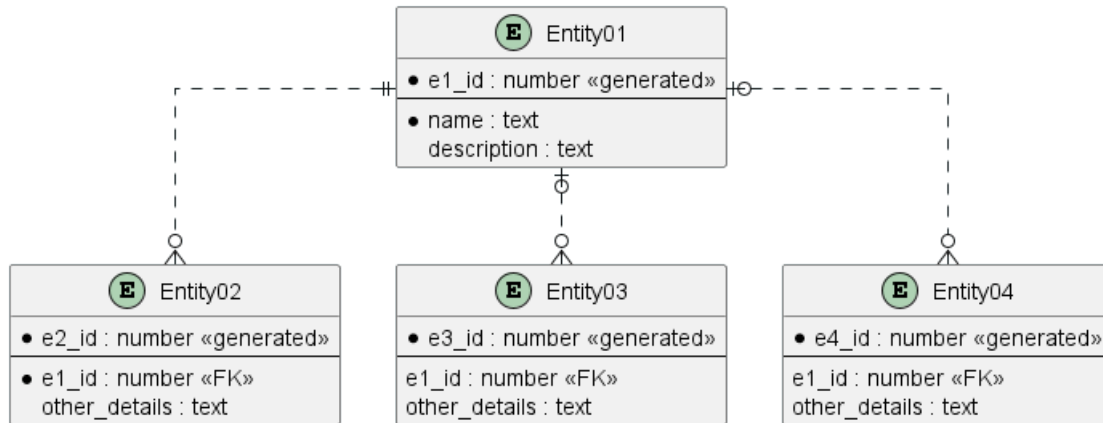

Currently the crows feet do not look very good when the relationship is drawn at an angle to the entity. This can be avoided by using the `linetype ortho` skinparam.

## 21 Common Commands in PlantUML

Discover the fundamental commands universally applicable across all diagram types in PlantUML. These commands allow you to inject versatility and personalized details into your diagrams. Below, we break-down these common commands into three major categories:

### 21.0.1 Global Elements

- **Comments:** Add remarks or explanatory notes in your diagram script to convey additional information or to leave reminders for further modifications.
- **Notes:** Incorporate supplementary information directly onto your diagram to aid in understanding or to highlight important aspects.
- **Size Control:** Adjust the dimensions of various elements to suit your preferences, ensuring a balanced and well-proportioned diagram.
- **Title and Captions:** Define a fitting title and add captions to elucidate the context or to annotate specific parts of your diagram.

### 21.0.2 Creole Syntax Description

Harness the power of Creole syntax to further format the content of any element within your diagram. This wiki markup style allows for:

- **Text Formatting:** Customize the appearance of your text with various styles and alignments.
- **Lists:** Create ordered or unordered lists to present information neatly.
- **Links:** Integrate hyperlinks to facilitate quick navigation to relevant resources.

### 21.0.3 Style Control Command

Gain complete control over the presentation style of your diagram elements using the `style` command. Utilize this to:

- **Define Styles:** Set uniform styles for elements to maintain a cohesive visual theme.
- **Customize Colors:** Choose specific colors for various elements to enhance visual appeal and to create distinct classifications.

Explore these commands to create diagrams that are both functional and aesthetically pleasing, tailoring each element to your exact specifications.

## 21.1 Comments

### 21.1.1 Simple comment

Everything that starts with `simple quote '` is a comment.

```
@startuml
'Line comments use a single apostrophe
@enduml
```

### 21.1.2 Block comment

Block comment use C-style comments except that instead of `*` you use an apostrophe `'`, then you can also put comments on several lines using `/'` to start and `/'` to end.

```
@startuml
/'
many lines comments
here
/'
@enduml
```



[Ref. QA-1353]

Then you can also put block comment on the same line, as:

```
@startuml
/' case 1 '/  A -> B : AB-First step
              B -> C : BC-Second step
/' case 2 '/  D -> E : DE-Third step
@enduml
```

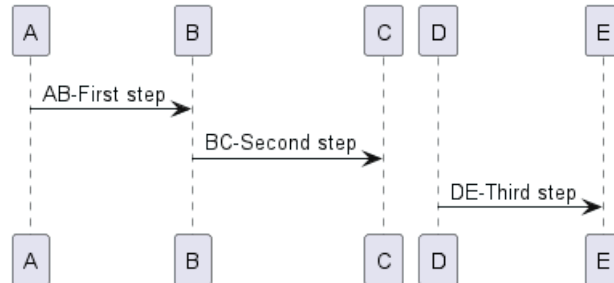

[Ref. QA-3906 and QA-3910]

### 21.1.1.3 Full example

```
@startuml
skinparam activity {
  ' this is a comment
  BackgroundColor White
  BorderColor Black '/' this is a comment '/'
  BorderColor Red ' this is not a comment and this line is ignored
}

start
:foo1;
@enduml
```



[Ref. GH-214]

## 21.2 Zoom

You can use the `scale` command to zoom the generated image.

You can use either *a number* or *a fraction* to define the scale factor. You can also specify either `width` or `height` (*in pixel*). And you can also give both `width` and `height`: the image is scaled to fit inside the specified dimension.

- `scale 1.5`
- `scale 2/3`
- `scale 200 width`
- `scale 200 height`
- `scale 200*100`
- `scale max 300*200`
- `scale max 1024 width`



- scale max 800 height

```
@startuml
scale 180*90
Bob->Alice : hello
@enduml
```



## 21.3 Title

The `title` keywords is used to put a title. You can add newline using `\n` in the title description.

Some `skinparam` settings are available to put borders on the title.

```
@startuml
skinparam titleBorderRoundCorner 15
skinparam titleBorderThickness 2
skinparam titleBorderColor red
skinparam titleBackgroundColor Aqua-CadetBlue
```

```
title Simple communication\nexample
```

```
Alice -> Bob: Authentication Request
Bob --> Alice: Authentication Response
```

```
@enduml
```

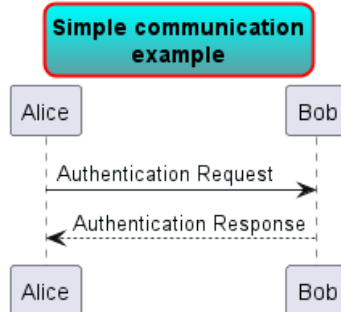

You can use creole formatting in the title.

You can also define title on several lines using `title` and `end title` keywords.

```
@startuml

title
  <u>Simple</u> communication example
  on <i>several</i> lines and using <back:cadetblue>creole tags</back>
end title
```

```
Alice -> Bob: Authentication Request
Bob -> Alice: Authentication Response
```

```
@enduml
```



**Simple communication example  
on several/lines and using creole tags**

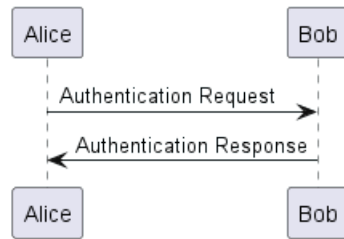

## 21.4 Caption

There is also a `caption` keyword to put a caption under the diagram.

```

@startuml

caption figure 1
Alice -> Bob: Hello

@enduml
  
```

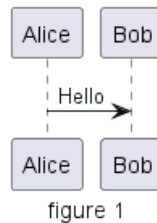

## 21.5 Footer and header

You can use the commands `header` or `footer` to add a footer or a header on any generated diagram.

You can optionally specify if you want a `center`, `left` or `right` footer/header, by adding a keyword.

As with `title`, it is possible to define a header or a footer on several lines.

It is also possible to put some HTML into the header or footer.

```

@startuml
Alice -> Bob: Authentication Request

header
<font color=red>Warning:</font>
Do not use in production.
endheader

center footer Generated for demonstration

@enduml
  
```

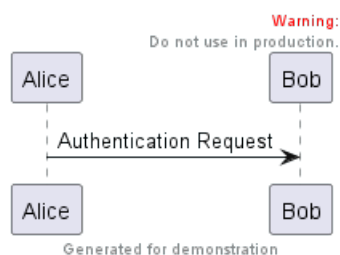

## 21.6 Legend the diagram

The `legend` and `end legend` are keywords is used to put a legend.

You can optionally specify to have `left`, `right`, `top`, `bottom` or `center` alignment for the legend.

```
@startuml
Alice -> Bob : Hello
legend right
  Short
  legend
endlegend
@enduml
```

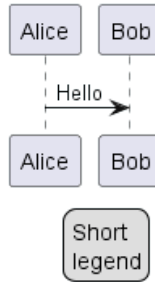

```
@startuml
Alice -> Bob : Hello
legend top left
  Short
  legend
endlegend
@enduml
```

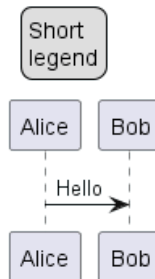

## 21.7 Appendix: Examples on all diagram

### 21.7.1 Activity

```
@startuml
header some header

footer some footer

title My title

caption This is caption

legend
The legend
end legend

start
```



```

:Hello world;
:This is defined on
several lines;
stop

@enduml

```

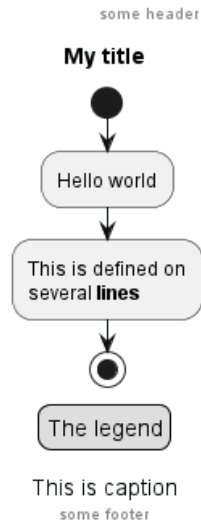

### 21.7.2 Archimate

```

@startuml
header some header

footer some footer

title My title

caption This is caption

legend
The legend
end legend

archimate #Technology "VPN Server" as vpnServerA <<technology-device>>

rectangle GO #lightgreen
rectangle STOP #red
rectangle WAIT #orange

@enduml

```



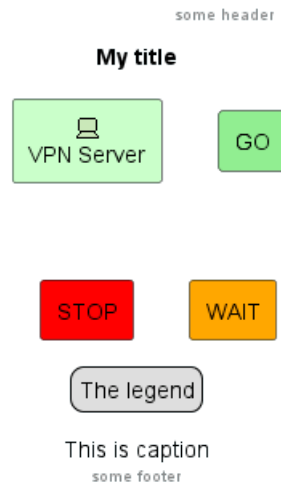

### 21.7.3 Class

```

@startuml
header some header

footer some footer

title My title

caption This is caption

legend
The legend
end legend

a -- b

@enduml

```

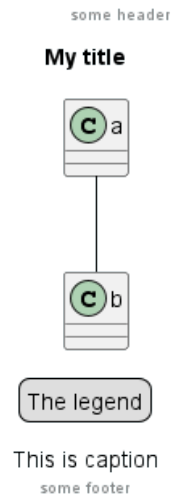

### 21.7.4 Component, Deployment, Use-Case

```

@startuml
header some header

footer some footer

```



```

title My title

caption This is caption

legend
The legend
end legend

node n
(u) -> [c]

@enduml

```

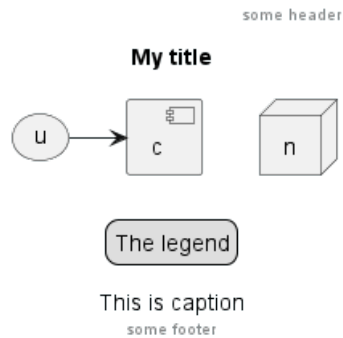

### 21.7.5 Gantt project planning

```

@startgantt
header some header

footer some footer

title My title

caption This is caption

legend
The legend
end legend

[t] lasts 5 days

@endgantt

```

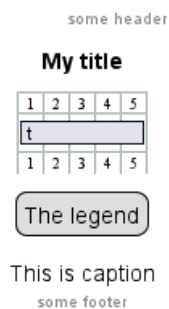

**TODO:** DONE [(Header, footer) corrected on V1.2020.18]

### 21.7.6 Object

```

@startuml

```



```

header some header

footer some footer

title My title

caption This is caption

legend
The legend
end legend

object user {
  name = "Dummy"
  id = 123
}

@enduml

```

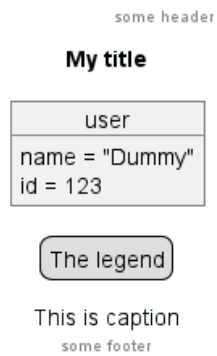

### 21.7.7 MindMap

```

@startmindmap
header some header

footer some footer

title My title

caption This is caption

legend
The legend
end legend

* r
** d1
** d2

@endmindmap

```



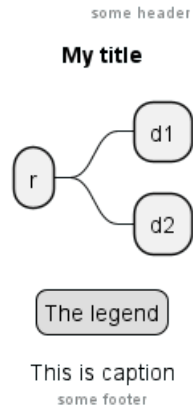

### 21.7.8 Network (nwdiag)

```

@startuml
header some header

footer some footer

title My title

caption This is caption

legend
The legend
end legend

nwdiag {
  network inet {
    web01 [shape = cloud]
  }
}

@enduml
  
```

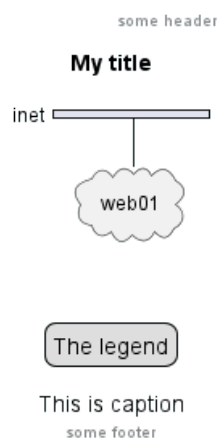

### 21.7.9 Sequence

```

@startuml
header some header

footer some footer
  
```



```

title My title

caption This is caption

legend
The legend
end legend

a->b
@enduml

```

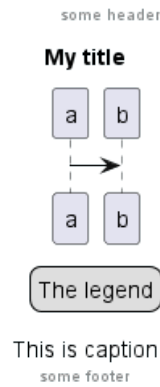

### 21.7.10 State

```

@startuml
header some header

footer some footer

title My title

caption This is caption

legend
The legend
end legend

[*] --> State1
State1 -> State2

@enduml

```

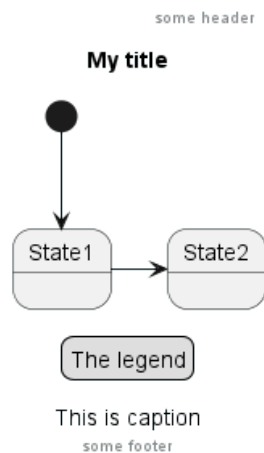

### 21.7.11 Timing

```

@startuml
header some header

footer some footer

title My title

caption This is caption

legend
The legend
end legend

robust "Web Browser" as WB
concise "Web User" as WU

@0
WU is Idle
WB is Idle

@100
WU is Waiting
WB is Processing

@300
WB is Waiting

@enduml

```

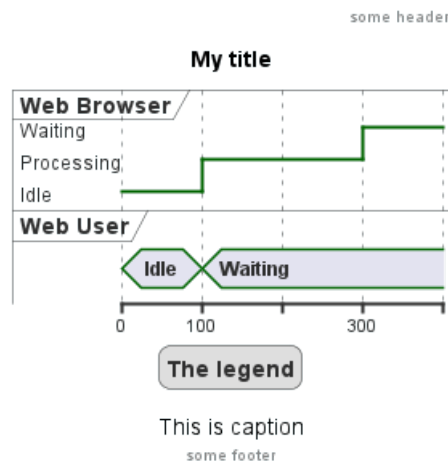

### 21.7.12 Work Breakdown Structure (WBS)

```

@startwbs
header some header

footer some footer

title My title

caption This is caption

legend

```



```
The legend
end legend
```

```
* r
** d1
** d2
```

```
@endwbs
```

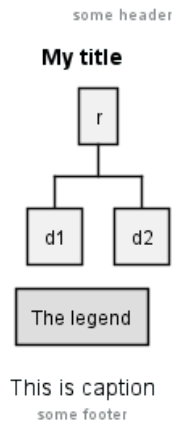

**TODO: DONE** [Corrected on V1.2020.17]

### 21.7.13 Wireframe (SALT)

```
@startsalt
header some header
```

```
footer some footer
```

```
title My title
```

```
caption This is caption
```

```
legend
The legend
end legend
```

```
{+
  Login    | "MyName  "
  Password | "****    "
  [Cancel] | [ OK   ]
}
@endsalt
```



**TODO:** DONE [Corrected on V1.2020.18]

## 21.8 Appendix: Examples on all diagram with style

**TODO:** DONE

FYI:

- all is only good for **Sequence diagram**
- title, caption and legend are good for all diagrams except for **salt diagram**

**TODO:** FIXME

- Now (*test on 1.2020.18-19*) header, footer are not good for **all other diagrams** except only for **Sequence diagram**.

To be fix; Thanks

**TODO:** FIXME

Here are tests of title, header, footer, caption or legend on all the diagram with the debug style:

```
<style>
title {
  HorizontalAlignment right
  FontSize 24
  FontColor blue
}

header {
  HorizontalAlignment center
  FontSize 26
  FontColor purple
}

footer {
  HorizontalAlignment left
  FontSize 28
  FontColor red
}

legend {
  FontSize 30
  BackGroundColor yellow
  Margin 30
  Padding 50
}

caption {
  FontSize 32
}
</style>
```

### 21.8.1 Activity

```
@startuml
<style>
title {
  HorizontalAlignment right
  FontSize 24
  FontColor blue
}

```





```
header {  
  HorizontalAlignment center  
  FontSize 26  
  FontColor purple  
}
```

```
footer {  
  HorizontalAlignment left  
  FontSize 28  
  FontColor red  
}
```

```
legend {  
  FontSize 30  
  BackGroundColor yellow  
  Margin 30  
  Padding 50  
}
```

```
caption {  
  FontSize 32  
}
```

```
</style>
```

```
header some header
```

```
footer some footer
```

```
title My title
```

```
caption This is caption
```

```
legend  
The legend  
end legend
```

```
start  
:Hello world;  
:This is defined on  
several lines;  
stop
```

```
@enduml
```

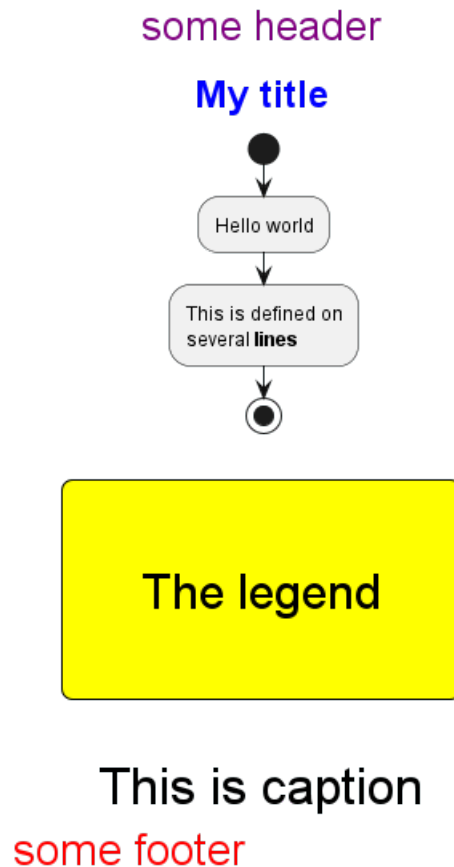

### 21.8.2 Archimate

```

@startuml
<style>
title {
  HorizontalAlignment right
  FontSize 24
  FontColor blue
}

header {
  HorizontalAlignment center
  FontSize 26
  FontColor purple
}

footer {
  HorizontalAlignment left
  FontSize 28
  FontColor red
}

legend {
  FontSize 30
  BackGroundColor yellow
  Margin 30
  Padding 50
}
  
```

```

caption {
  FontSize 32
}
</style>
header some header

footer some footer

title My title

caption This is caption

legend
The legend
end legend

archimate #Technology "VPN Server" as vpnServerA <<technology-device>>

rectangle GO #lightgreen
rectangle STOP #red
rectangle WAIT #orange

@enduml

```

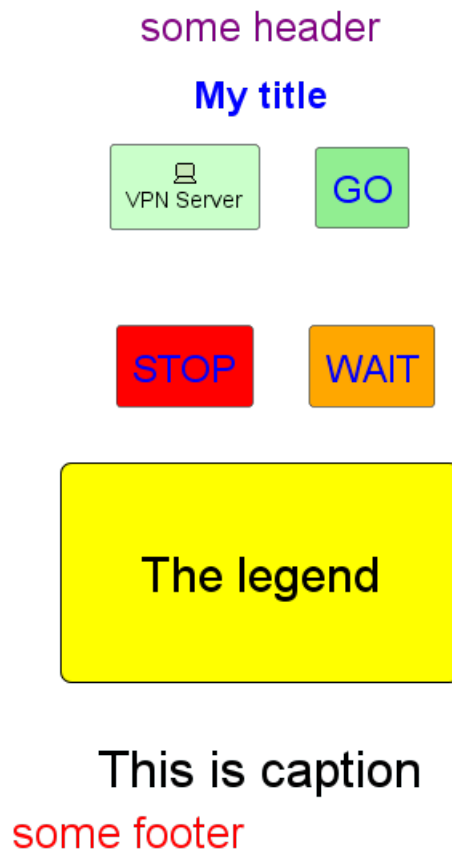

### 21.8.3 Class

```

@startuml
<style>
title {
  HorizontalAlignment right
  FontSize 24

```



```
    FontColor blue
}

header {
    HorizontalAlignment center
    FontSize 26
    FontColor purple
}

footer {
    HorizontalAlignment left
    FontSize 28
    FontColor red
}

legend {
    FontSize 30
    BackGroundColor yellow
    Margin 30
    Padding 50
}

caption {
    FontSize 32
}
</style>
header some header

footer some footer

title My title

caption This is caption

legend
The legend
end legend

a -- b

@enduml
```

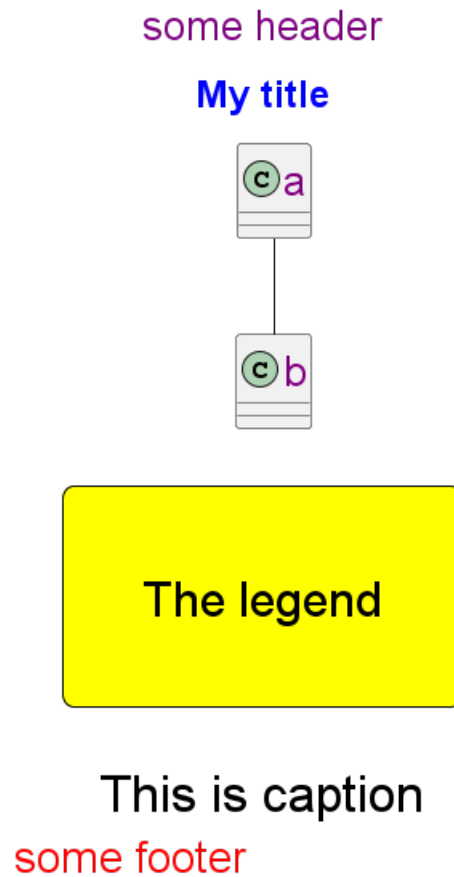

#### 21.8.4 Component, Deployment, Use-Case

```

@startuml
<style>
title {
  HorizontalAlignment right
  FontSize 24
  FontColor blue
}

header {
  HorizontalAlignment center
  FontSize 26
  FontColor purple
}

footer {
  HorizontalAlignment left
  FontSize 28
  FontColor red
}

legend {
  FontSize 30
  BackGroundColor yellow
  Margin 30
  Padding 50
}

```



```

caption {
  FontSize 32
}
</style>
header some header

footer some footer

title My title

caption This is caption

legend
The legend
end legend

node n
(u) -> [c]

@enduml

```

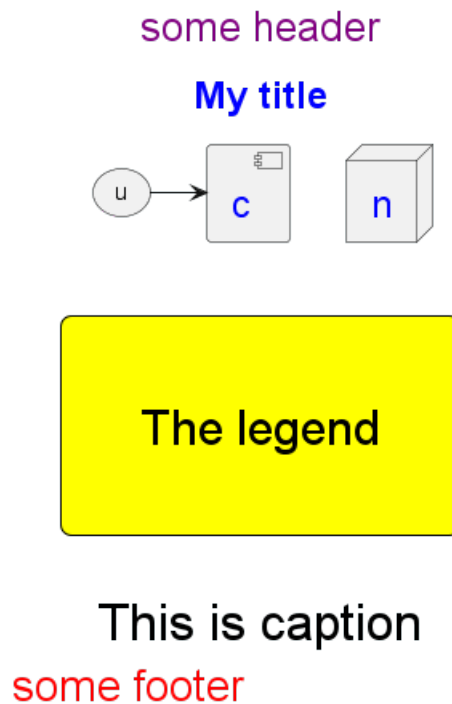

### 21.8.5 Gantt project planning

```

@startgantt
<style>
title {
  HorizontalAlignment right
  FontSize 24
  FontColor blue
}

header {
  HorizontalAlignment center
  FontSize 26
  FontColor purple
}

```



```

}

footer {
  HorizontalAlignment left
  FontSize 28
  FontColor red
}

legend {
  FontSize 30
  BackGroundColor yellow
  Margin 30
  Padding 50
}

caption {
  FontSize 32
}
</style>
header some header

footer some footer

title My title

caption This is caption

legend
The legend
end legend

[t] lasts 5 days

@endgantt

```

some header

**My title**

1	2	3	4	5
t				
1	2	3	4	5

The legend

This is caption  
some footer



### 21.8.6 Object

```
@startuml
<style>
title {
  HorizontalAlignment right
  FontSize 24
  FontColor blue
}

header {
  HorizontalAlignment center
  FontSize 26
  FontColor purple
}

footer {
  HorizontalAlignment left
  FontSize 28
  FontColor red
}

legend {
  FontSize 30
  BackGroundColor yellow
  Margin 30
  Padding 50
}

caption {
  FontSize 32
}
</style>
header some header

footer some footer

title My title

caption This is caption

legend
The legend
end legend

object user {
  name = "Dummy"
  id = 123
}

@enduml
```





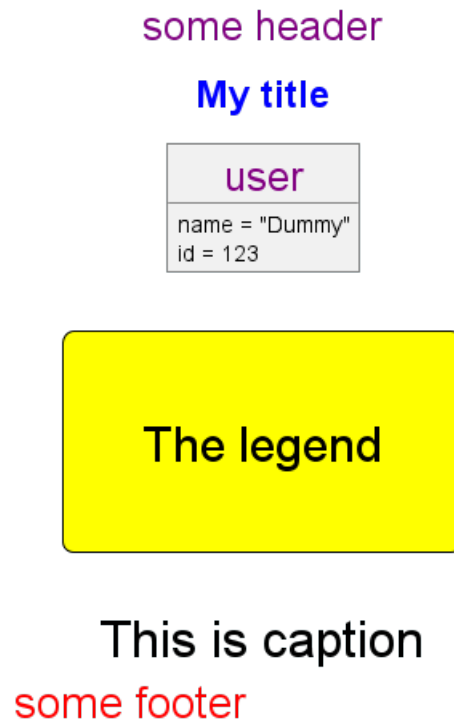

### 21.8.7 MindMap

```

@startmindmap
<style>
title {
  HorizontalAlignment right
  FontSize 24
  FontColor blue
}

header {
  HorizontalAlignment center
  FontSize 26
  FontColor purple
}

footer {
  HorizontalAlignment left
  FontSize 28
  FontColor red
}

legend {
  FontSize 30
  BackGroundColor yellow
  Margin 30
  Padding 50
}

caption {
  FontSize 32
}
</style>
header some header

```



```

footer some footer

title My title

caption This is caption

legend
The legend
end legend

* r
** d1
** d2

@endmindmap

```

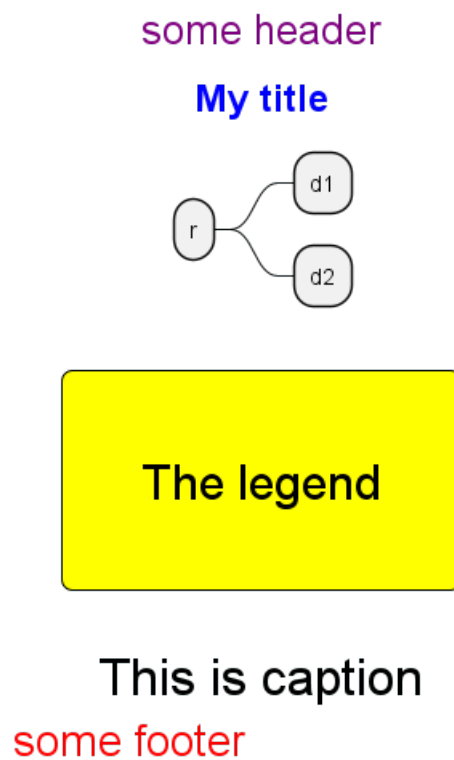

### 21.8.8 Network (nwdiag)

```

@startuml
<style>
title {
  HorizontalAlignment right
  FontSize 24
  FontColor blue
}

header {
  HorizontalAlignment center
  FontSize 26
  FontColor purple
}

```



```
footer {
  HorizontalAlignment left
  FontSize 28
  FontColor red
}

legend {
  FontSize 30
  BackGroundColor yellow
  Margin 30
  Padding 50
}

caption {
  FontSize 32
}
</style>
header some header

footer some footer

title My title

caption This is caption

legend
The legend
end legend

nwdiag {
  network inet {
    web01 [shape = cloud]
  }
}

@enduml
```

some header

**My title**

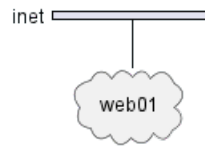

The legend

This is caption  
some footer

### 21.8.9 Sequence

```

@startuml
<style>
title {
  HorizontalAlignment right
  FontSize 24
  FontColor blue
}

header {
  HorizontalAlignment center
  FontSize 26
  FontColor purple
}

footer {
  HorizontalAlignment left
  FontSize 28
  FontColor red
}

legend {
  FontSize 30
  BackGroundColor yellow
  Margin 30
  Padding 50
}

caption {
  FontSize 32
}
</style>
  
```



```

header some header

footer some footer

title My title

caption This is caption

legend
The legend
end legend

a->b
@enduml

```

some header

**My title**

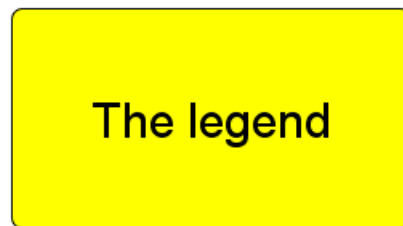
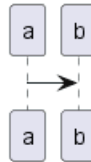

This is caption

some footer

#### 21.8.10 State

```

@startuml
<style>
title {
  HorizontalAlignment right
  FontSize 24
  FontColor blue
}

header {
  HorizontalAlignment center
  FontSize 26
  FontColor purple
}

footer {
  HorizontalAlignment left
  FontSize 28

```



```

    FontColor red
  }

  legend {
    FontSize 30
    BackGroundColor yellow
    Margin 30
    Padding 50
  }

  caption {
    FontSize 32
  }
</style>
header some header

footer some footer

title My title

caption This is caption

legend
The legend
end legend

[*] --> State1
State1 -> State2

@enduml

```

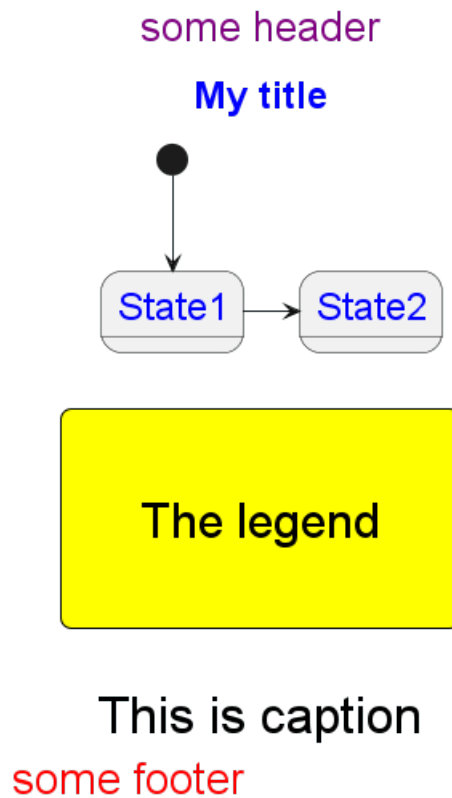

**21.8.11 Timing**

```

@startuml
<style>
title {
  HorizontalAlignment right
  FontSize 24
  FontColor blue
}

header {
  HorizontalAlignment center
  FontSize 26
  FontColor purple
}

footer {
  HorizontalAlignment left
  FontSize 28
  FontColor red
}

legend {
  FontSize 30
  BackGroundColor yellow
  Margin 30
  Padding 50
}

caption {
  FontSize 32
}
</style>
header some header

footer some footer

title My title

caption This is caption

legend
The legend
end legend

robust "Web Browser" as WB
concise "Web User" as WU

@0
WU is Idle
WB is Idle

@100
WU is Waiting
WB is Processing

@300
WB is Waiting

```



```
@enduml
```

some header

My title

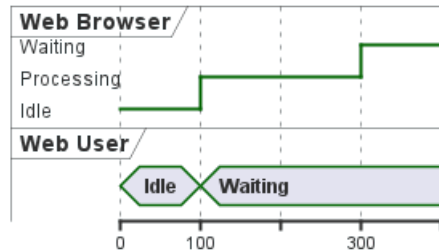

The legend

This is caption

some footer

### 21.8.12 Work Breakdown Structure (WBS)

```
@startwbs
<style>
title {
  HorizontalAlignment right
  FontSize 24
  FontColor blue
}

header {
  HorizontalAlignment center
  FontSize 26
  FontColor purple
}

footer {
  HorizontalAlignment left
  FontSize 28
  FontColor red
}

legend {
  FontSize 30
  BackGroundColor yellow
  Margin 30
  Padding 50
}
```





```

caption {
  FontSize 32
}
</style>
header some header

footer some footer

title My title

caption This is caption

legend
The legend
end legend

* r
** d1
** d2

@endwbs

```

some header

**My title**

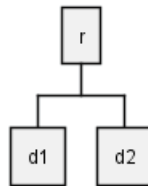

The legend

This is caption  
some footer

### 21.8.13 Wireframe (SALT)

**TODO: FIXME** Fix all (title, caption, legend, header, footer) for salt. **TODO: FIXME**

```

@startsalt
<style>
title {
  HorizontalAlignment right
  FontSize 24
  FontColor blue
}

```



```

header {
  HorizontalAlignment center
  FontSize 26
  FontColor purple
}

footer {
  HorizontalAlignment left
  FontSize 28
  FontColor red
}

legend {
  FontSize 30
  BackGroundColor yellow
  Margin 30
  Padding 50
}

caption {
  FontSize 32
}
</style>
@startsalt
header some header

footer some footer

title My title

caption This is caption

legend
The legend
end legend

{+
  Login | "MyName  "
  Password | "****  "
  [Cancel] | [ OK ]
}
@endsalt

```



## 21.9 Mainframe

```

@startuml
mainframe This is a mainframe

```



```
Alice->Bob : Hello
@enduml
```

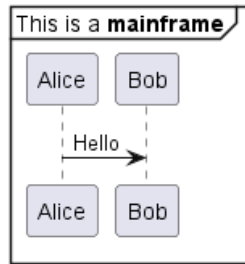

[Ref. QA-4019 and Issue#148]

## 21.10 Appendix: Examples of Mainframe on all diagram

### 21.10.1 Activity

```
@startuml
mainframe This is a **mainframe**

start
:Hello world;
:This is defined on
several **lines**;;
stop
@enduml
```

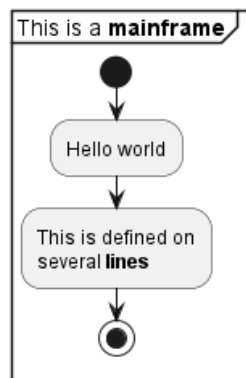

### 21.10.2 Archimate

```
@startuml
mainframe This is a **mainframe**

archimate #Technology "VPN Server" as vpnServerA <<technology-device>>
rectangle GO #lightgreen
rectangle STOP #red
rectangle WAIT #orange
@enduml
```

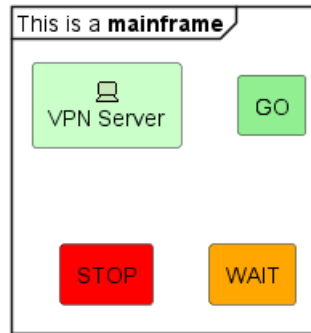

**TODO: FIXME** Cropped on the top and on the left **TODO: FIXME**

### 21.10.3 Class

```
@startuml
mainframe This is a **mainframe**

a -- b
@enduml
```

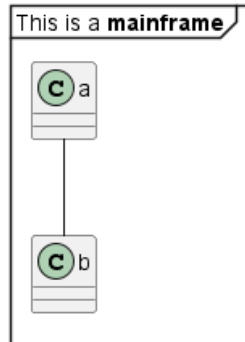

**TODO: FIXME** Cropped on the top and on the left **TODO: FIXME**

### 21.10.4 Component, Deployment, Use-Case

```
@startuml
mainframe This is a **mainframe**

node n
(u) -> [c]
@enduml
```

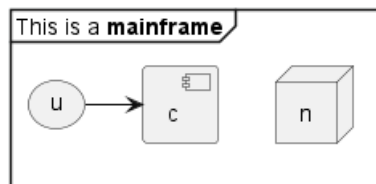

**TODO: FIXME** Cropped on the top and on the left **TODO: FIXME**

### 21.10.5 Gantt project planning

```
@startgantt
mainframe This is a **mainframe**

[t] lasts 5 days
@endgantt
```

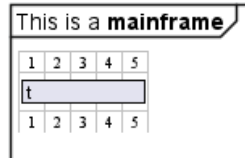

**TODO: FIXME** Cropped on the top and on the left **TODO: FIXME**

### 21.10.6 Object

```
@startuml
mainframe This is a **mainframe**

object user {
    name = "Dummy"
    id = 123
}
@enduml
```

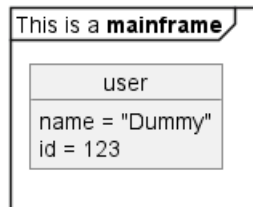

**TODO: FIXME** Cropped on the top! **TODO: FIXME**

### 21.10.7 MindMap

```
@startmindmap
mainframe This is a **mainframe**

* r
** d1
** d2
@endmindmap
```

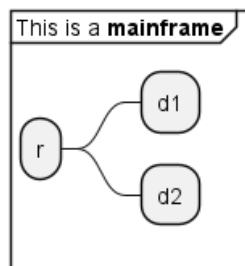

### 21.10.8 Network (nwdiag)

```
@startuml
mainframe This is a **mainframe**

nwdiag {
    network inet {
        web01 [shape = cloud]
    }
}
@enduml
```



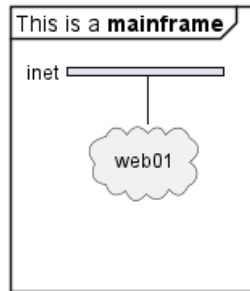

**TODO: FIXME** Cropped on the top! **TODO: FIXME**

### 21.10.9 Sequence

```
@startuml
mainframe This is a **mainframe**

a->b
@enduml
```

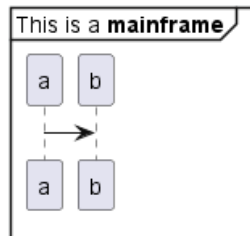

### 21.10.10 State

```
@startuml
mainframe This is a **mainframe**

[*] --> State1
State1 -> State2
@enduml
```

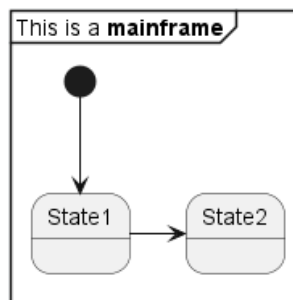

**TODO: FIXME** Cropped on the top and on the left **TODO: FIXME**

### 21.10.11 Timing

```
@startuml
mainframe This is a **mainframe**

robust "Web Browser" as WB
concise "Web User" as WU
@0
WU is Idle
```

```
WB is Idle
@100
WU is Waiting
WB is Processing
@300
WB is Waiting
@enduml
```

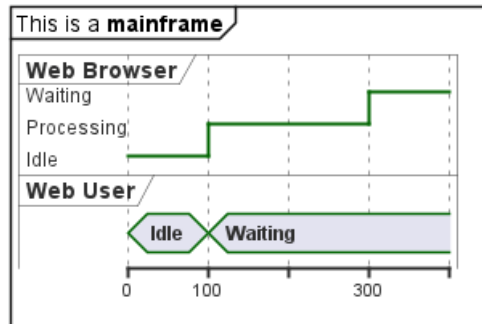

### 21.10.12 Work Breakdown Structure (WBS)

```
@startwbs
mainframe This is a mainframe
* r
** d1
** d2
@endwbs
```

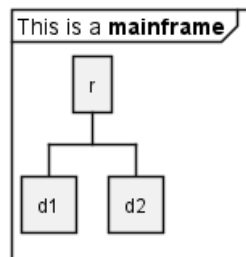

### 21.10.13 Wireframe (SALT)

```
@startsalt
mainframe This is a mainframe
{+
  Login | "MyName" |
  Password | "****" |
  [Cancel] | [ OK ]
}
@sendsalt
```

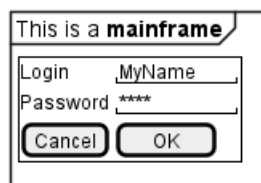

## 21.11 Appendix: Examples of title, header, footer, caption, legend and mainframe on all diagram

### 21.11.1 Activity

```

@startuml
mainframe This is a **mainframe**
header some header

footer some footer

title My title

caption This is caption

legend
The legend
end legend

start
:Hello world;
:This is defined on
several **lines**;
stop

@enduml

```

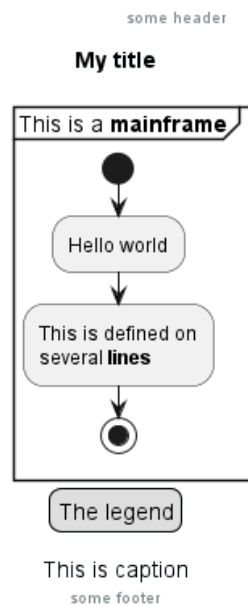

### 21.11.2 Archimate

```

@startuml
mainframe This is a **mainframe**
header some header

footer some footer

title My title

caption This is caption

```





```

legend
The legend
end legend

archimate #Technology "VPN Server" as vpnServerA <<technology-device>>

rectangle GO #lightgreen
rectangle STOP #red
rectangle WAIT #orange

@enduml

```

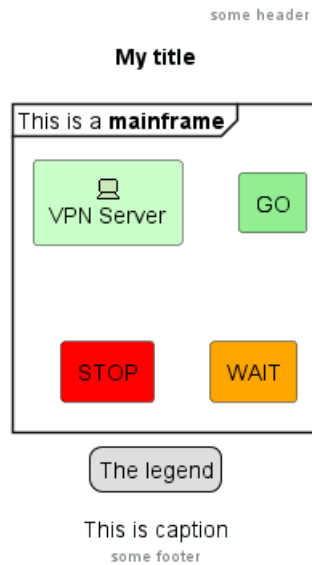

### 21.11.3 Class

```

@startuml
mainframe This is a mainframe
header some header

footer some footer

title My title

caption This is caption

legend
The legend
end legend

a -- b

@enduml

```

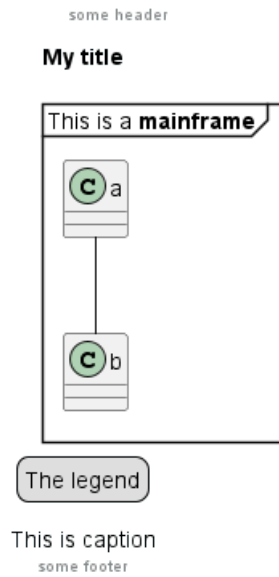

#### 21.11.4 Component, Deployment, Use-Case

```
@startuml
mainframe This is a **mainframe**
header some header

footer some footer

title My title

caption This is caption

legend
The legend
end legend

node n
(u) -> [c]

@enduml
```

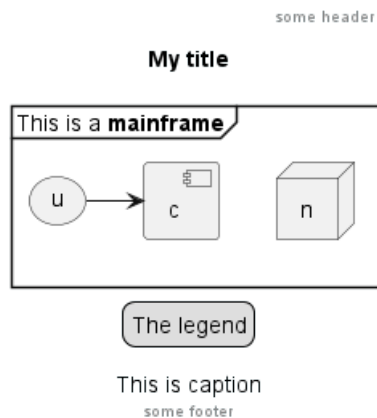

#### 21.11.5 Gantt project planning

```
@startgantt
mainframe This is a **mainframe**
header some header
```



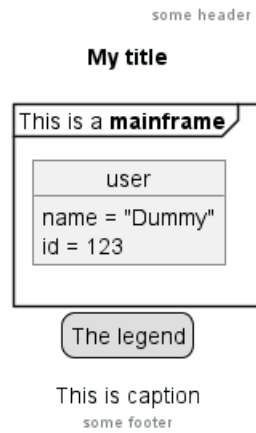

### 21.11.7 MindMap

```
@startmindmap
mainframe This is a mainframe
header some header

footer some footer

title My title

caption This is caption

legend
The legend
end legend

* r
** d1
** d2

@endmindmap
```

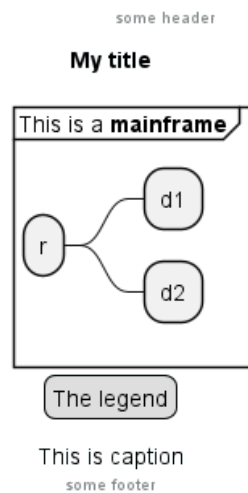

### 21.11.8 Network (nwdiag)

```
@startuml
mainframe This is a mainframe
header some header
```

```

footer some footer

title My title

caption This is caption

legend
The legend
end legend

nwdiag {
  network inet {
    web01 [shape = cloud]
  }
}

@enduml

```

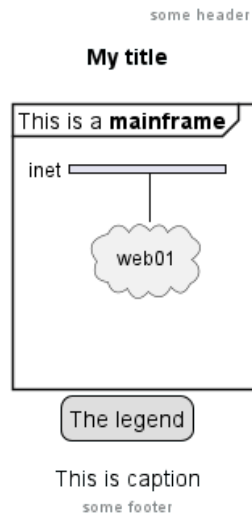

### 21.11.9 Sequence

```

@startuml
mainframe This is a mainframe
header some header

footer some footer

title My title

caption This is caption

legend
The legend
end legend

a->b
@enduml

```

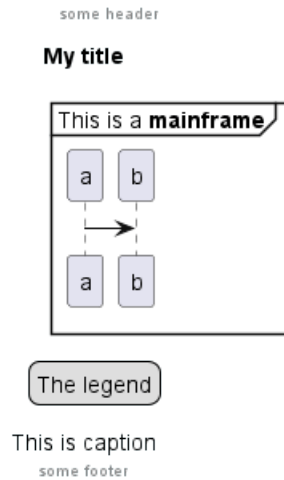

### 21.11.10 State

```

@startuml
mainframe This is a mainframe
header some header

footer some footer

title My title

caption This is caption

legend
The legend
end legend

[*] --> State1
State1 -> State2

@enduml
    
```

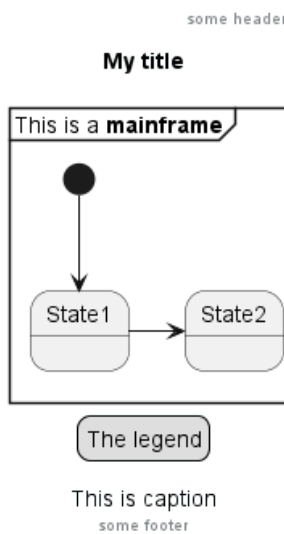

### 21.11.11 Timing

```

@startuml
mainframe This is a mainframe
    
```

```

header some header

footer some footer

title My title

caption This is caption

legend
The legend
end legend

robust "Web Browser" as WB
concise "Web User" as WU

@0
WU is Idle
WB is Idle

@100
WU is Waiting
WB is Processing

@300
WB is Waiting

@enduml

```

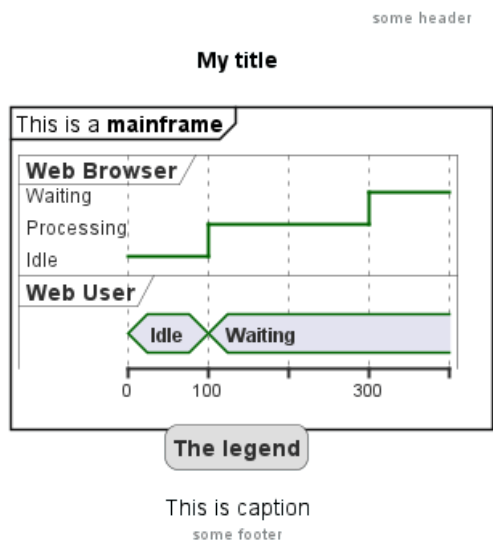

### 21.11.12 Work Breakdown Structure (WBS)

```

@startwbs
mainframe This is a **mainframe**
header some header

footer some footer

title My title

caption This is caption

```

```
legend
The legend
end legend
```

```
* r
** d1
** d2
```

```
@endwbs
```

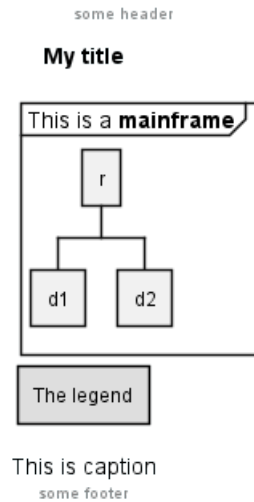

### 21.11.13 Wireframe (SALT)

```
@startsalt
mainframe This is a **mainframe**
header some header
```

```
footer some footer
```

```
title My title
```

```
caption This is caption
```

```
legend
The legend
end legend
```

```
{+
  Login    | "MyName  "
  Password | "****   "
  [Cancel] | [ OK   ]
}
@endsalt
```



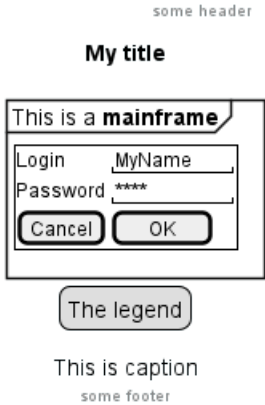

## 22 Creole

Creole is a lightweight common markup language for various wikis. A light-weight Creole engine is integrated in PlantUML to have a standardized way to emit styled text.

All diagrams support this syntax.

Note that compatibility with HTML syntax is preserved.

### 22.1 Emphasized text

```
@startuml
Alice -> Bob : hello there here
... Some long delay ...
Bob -> Alice : ok
note left
  This is bold
  This is italics
  This is "monospaced"
  This is stricken-out
  This is underlined
  This is wave-underlined
end note
@enduml
```

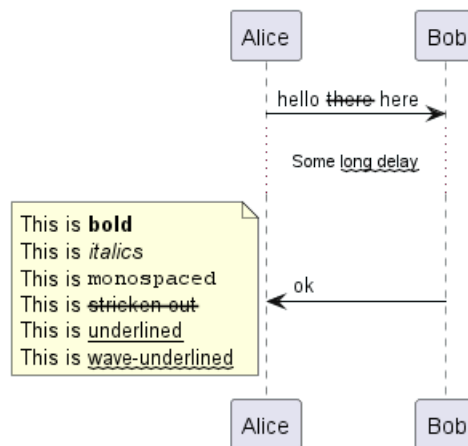

### 22.2 Lists

You can use numbered and bulleted lists in node text, notes, etc.

**TODO: FIXME** You cannot quite mix numbers and bullets in a list and its sublist.

```
@startuml
object demo {
  * Bullet list
  * Second item
}
note left
  * Bullet list
  * Second item
  ** Sub item
end note

legend
  # Numbered list
  # Second item
  ## Sub item
```



```

## Another sub item
  * Can't quite mix
  * Numbers and bullets
# Third item
end legend
@enduml

```

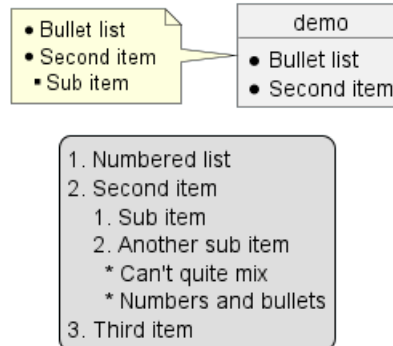

## 22.3 Escape character

You can use the tilde ~ to escape special creole characters.

```

@startuml
object demo {
  This is not ~___underscored___.
  This is not ~""monospaced"".
}
@enduml

```

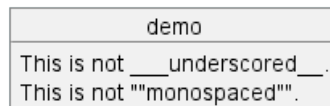

## 22.4 Headings

```

@startuml
usecase UC1 as "
= Extra-large heading
Some text
== Large heading
Other text
=== Medium heading
Information
....
==== Small heading"
@enduml

```

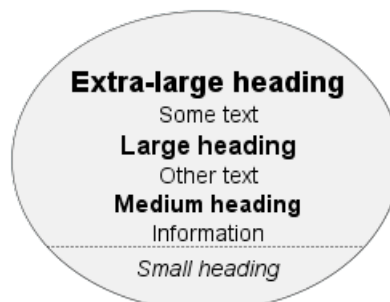

## 22.5 Emoji

All emojis from Twemoji (see [EmojiTwo](#) on Github) are available using the following syntax:

```
@startuml
Alice -> Bob : Hello <:1f600:>
return <:innocent:>
Alice -> Bob : Without color: <#0:sunglasses:>
Alice -> Bob : Change color: <#green:sunny:>
@enduml
```

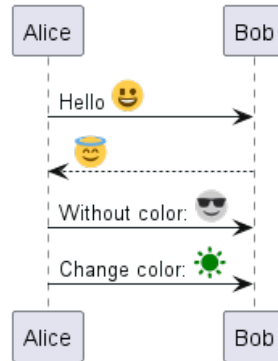

Unlike Unicode Special characters that depend on installed fonts, the emoji are always available. Furthermore, emoji are already colored, but you can recolor them if you like (see examples above).

One can pick emoji from the emoji cheat sheet, the Unicode full-emoji-list, or the flat list emoji.txt in the plantuml source.

You can also use the following PlantUML command to list available emoji:

```
@startuml
emoji <block>
@enduml
```

As of 13 April 2023, you can select between 1174 emoji from the following Unicode blocks:

- Unicode block 26: 83 emoji
- Unicode block 27: 33 emoji
- Unicode block 1F3: 246 emoji
- Unicode block 1F4: 255 emoji
- Unicode block 1F5: 136 emoji
- Unicode block 1F6: 181 emoji
- Unicode block 1F9: 240 emoji

### 22.5.1 Unicode block 26

```
@startuml
emoji 26
@enduml
```

**Emoji available on Unicode Block 26**

(Blocks available: 26, 27, 1F3, 1F4, 1F5, 1F6, 1F9)

<:2600:> ☀️🌤️ <:sunny:>	<:264d:> ♍️♏️ <:virgo:>	<:26aa:> ◯◯ <:white_circle:>
<:2601:> ☁️☁️ <:cloud:>	<:264e:> ♎️♏️ <:libra:>	<:26ab:> ◼️◼️ <:black_circle:>
<:2602:> ☂️☂️ <:open_umbrella:>	<:264f:> ♏️♏️ <:scorpius:>	<:26b0:> ☪️☪️ <:coffin:>
<:2603:> 🧑‍❄️🧑‍❄️ <:snowman_with_snow:>	<:2650:> ♐️♑️ <:sagittarius:>	<:26b1:> 🪦🪦 <:funeral_urn:>
<:2604:> 🌠🌠 <:comet:>	<:2651:> ♑️♑️ <:capricorn:>	<:26bd:> ⚽⚽ <:soccer:>
<:260e:> 📞📞 <:phone:>	<:2652:> ♒️♓️ <:aquarius:>	<:26be:> ⚾️⚾️ <:baseball:>
<:2611:> 🗳️🗳️ <:ballot_box_with_check:>	<:2653:> ♓️♈️ <:pisces:>	<:26c4:> 🧑‍❄️🧑‍❄️ <:snowman:>
<:2614:> ☂️☂️ <:umbrella:>	<:265f:> ♟️♟️ <:chess_pawn:>	<:26c5:> 🌤️🌤️ <:partly_sunny:>
<:2615:> ☕☕ <:coffee:>	<:2660:> ♠️♠️ <:spades:>	<:26c8:> ⚡️🌧️ <:cloud_with_lightning_and_rain:>
<:2618:> 🍀🍀 <:shamrock:>	<:2663:> ♣️♣️ <:clubs:>	<:26ce:> 🐱🐱 <:ophiuchus:>
<:261d:> 👉👉 <:point_up:>	<:2665:> ❤️❤️ <:hearts:>	<:26cf:> 🛠️🛠️ <:pick:>
<:2620:> ☠️☠️ <:skull_and_crossbones:>	<:2666:> 💎💎 <:diamonds:>	<:26d1:> 🧑‍🚒🧑‍🚒 <:rescue_worker_helmet:>
<:2622:> ☢️☢️ <:radioactive:>	<:2668:> 🌋🌋 <:hotsprings:>	<:26d3:> ⛓️⛓️⛓️⛓️ <:chains:>
<:2623:> ☣️☣️ <:biohazard:>	<:267b:> ♻️♻️ <:recycle:>	<:26d4:> 🚫🚫 <:no_entry:>
<:2626:> ✝️✝️ <:orthodox_cross:>	<:267e:> ∞∞ <:infinity:>	<:26e9:> 🏯🏯 <:shinto_shrine:>
<:262a:> ⚹️☾ <:star_and_crescent:>	<:267f:> ♿♿ <:wheelchair:>	<:26ea:> 🏪🏪 <:church:>
<:262e:> ☮️☮️ <:peace_symbol:>	<:2692:> ⚒️⚒️ <:hammer_and_pick:>	<:26f0:> 🏔️⚡️ <:mountain:>
<:262f:> ☯️☯️ <:yin_yang:>	<:2693:> ⚓⚓ <:anchor:>	<:26f1:> 🏖️🌴️ <:parasol_on_ground:>
<:2638:> 🌀🌀 <:wheel_of_dharma:>	<:2694:> ⚔️⚔️ <:crossed_swords:>	<:26f2:> 🏰🏰 <:fountain:>
<:2639:> 😞😞 <:frowning_face:>	<:2695:> 🏥🏥 <:medical_symbol:>	<:26f3:> 🏌️🏌️ <:golf:>
<:263a:> 😌😌 <:relaxed:>	<:2696:> ⚖️⚖️ <:balance_scale:>	<:26f4:> 🚢🚢 <:ferry:>
<:2640:> ♀️♀️ <:female_sign:>	<:2697:> 🏺🏺 <:alembic:>	<:26f5:> 🚤🚤 <:boat:>
<:2642:> ♂️♂️ <:male_sign:>	<:2699:> ⚙️⚙️ <:gear:>	<:26f7:> 🏂🏂 <:skier:>
<:2648:> ♈️♈️ <:aries:>	<:269b:> ⚗️⚗️ <:atom_symbol:>	<:26f8:> 🛼🛼 <:ice_skate:>
<:2649:> ♉️♉️ <:taurus:>	<:269c:> 🌹🌹 <:fleur_de_lis:>	<:26f9:> 🏀🏀 <:bouncing_ball_person:>
<:264a:> ♊️♊️ <:gemini:>	<:26a0:> ⚠️⚠️ <:warning:>	<:26fa:> 🏕️🏕️ <:tent:>
<:264b:> ♋️♋️ <:cancer:>	<:26a1:> ⚡️⚡️ <:zap:>	<:26fd:> 🛢️🛢️ <:fuelpump:>
<:264c:> ♌️♌️ <:leo:>	<:26a7:> 🏳️‍⚧️🏳️‍⚧️ <:transgender_symbol:>	

## 22.6 Horizontal lines

```

@startuml
database DB1 as "
You can have horizontal line
----
Or double line
=====
Or strong line
-----
Or dotted line
..My title..
Enjoy!
"
note right
  This is working also in notes
  You can also add title in all these lines
  ==Title==
  --Another title--
end note

@enduml

```



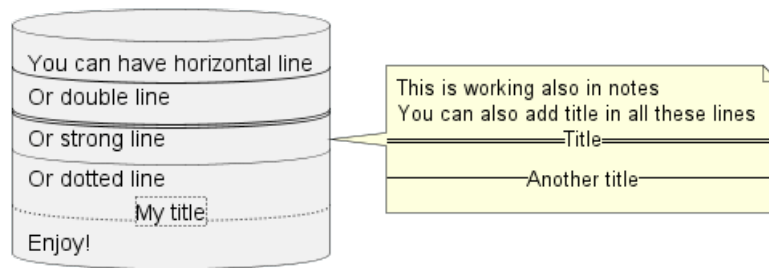

## 22.7 Links

You can also use URL and links.

Simple links are define using two square brackets (or three square brackets for field or method on class diagram).

Example:

- `[[http://plantuml.com]]`
- `[[http://plantuml.com This label is printed]]`
- `[[http://plantuml.com{Optional tooltip} This label is printed]]`

URL can also be authenticated.

## 22.8 Code

You can use `<code>` to display some programming code in your diagram (sorry, syntax highlighting is not yet supported).

```
@startuml
Alice -> Bob : hello
note right
<code>
main() {
    printf("Hello world");
}
</code>
end note
@enduml
```

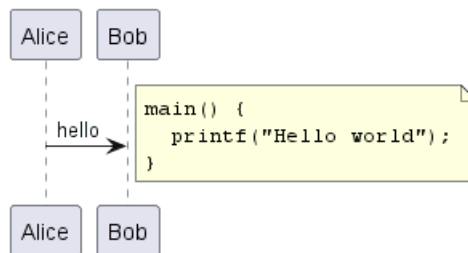

This is especially useful to illustrate some PlantUML code and the resulting rendering:

```
@startuml
hide footbox
note over Source
<code>
    This is bold
    This is italics
    This is "monospaced"
    This is stricken-out
    This is underlined
</code>
end note
@enduml
```



```

This is ~-wave-underlined~-
--test Unicode and icons--
This is <U+221E> long
This is a <&code> icon
</code>
end note
/note over Output
This is bold
This is //italics//
This is "monospaced"
This is --stricken-out--
This is __underlined__
This is ~-wave-underlined~-
--test Unicode and icons--
This is <U+221E> long
This is a <&code> icon
end note
@enduml

```

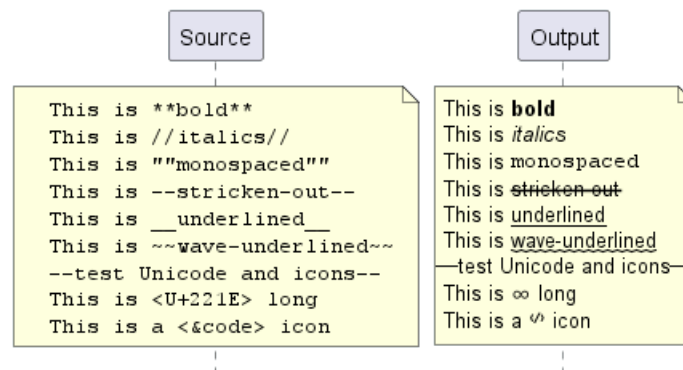

## 22.9 Table

### 22.9.1 Create a table

It is possible to build table, with | separator.

```

@startuml
skinparam titleFontSize 14
title
  Example of simple table
  |= |= table |= header |
  | a | table | row |
  | b | table | row |
end title
[*] --> State1
@enduml

```

Example of simple table

	table	header
a	table	row
b	table	row



### 22.9.2 Add color on rows or cells

You can specify background colors of rows and cells:

```
@startuml
start
:Here is the result
|= |= table |= header |
| a | table | row |
|<#FF8080> red |<#80FF80> green |<#8080FF> blue |
<#yellow>| b | table | row |;
@enduml
```

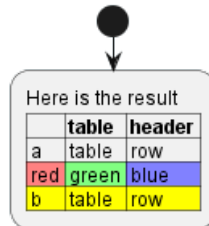

### 22.9.3 Add color on border and text

You can also specify colors of text and borders.

```
@startuml
title
<#lightblue,#red>|= Step |= Date |= Name |= Status |= Link |
<#lightgreen>| 1.1 | TBD | plantuml news |<#Navy><color:OrangeRed><b> Unknown | [[https://plantuml.org]]
end title
@enduml
```

Step	Date	Name	Status	Link
1.1	TBD	plantuml news	Unknown	plantuml news

[Ref. QA-7184]

### 22.9.4 No border or same color as the background

You can also set the border color to the same color as the background.

```
@startuml
node n
note right of n
  <#FBFB77,#FBFB77>|= Husky / Yorkie |= Foo |
  | SourceTree1 | foo1 |
  | ST2 | foo2 |
end note
@enduml
```

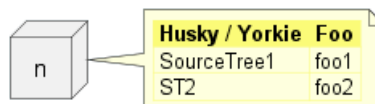

[Ref. QA-12448]

### 22.9.5 Bold header or not

= as the first char of a cell indicates whether to make it bold (usually used for headers), or not.





```

@startuml
note as deepCSS0
  |<#white> Husky / Yorkie |
  |=<#gainsboro> SourceTree0 |
endnote

note as deepCSS1
  |= <#white> Husky / Yorkie |= Foo |
  |<#gainsboro><r> SourceTree1 | foo1 |
endnote

note as deepCSS2
  |= Husky / Yorkie |
  |<#gainsboro> SourceTree2 |
endnote

note as deepCSS3
  <#white>|= Husky / Yorkie |= Foo |
  |<#gainsboro> SourceTree1 | foo1 |
endnote
@enduml

```

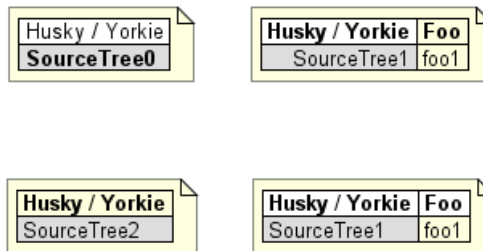

[Ref. QA-10923]

## 22.10 Tree

You can use |\_ characters to build a tree.

On common commands, like title:

```

@startuml
skinparam titleFontSize 14
title
  Example of Tree
  |_ First line
  |_ Bom (Model)
    |_ prop1
    |_ prop2
    |_ prop3
  |_ Last line
end title
[*] --> State1
@enduml

```



## Example of Tree

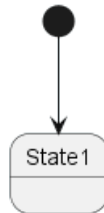
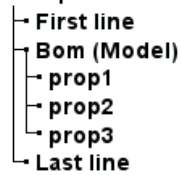

On Class diagram.

(Please note how we have to use an empty second compartment, else the parentheses in **(Model)** cause that text to be moved to a separate first compartment):

```

@startuml
class Foo {
**Bar (Model)**
|_ prop
|_ **Bom (Model)**
    |_ prop2
    |_ prop3
    |_ prop3.1
|_ prop4 :(
--
}
@enduml
  
```

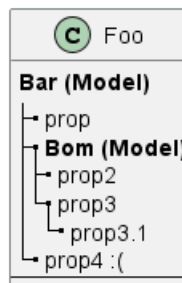

[Ref. QA-3448]

On Component or Deployment diagrams:

```

@startuml
[A] as A
rectangle "Box B" {
    component B [
        Level 1
        |_ Level 2a
            |_ Level 3a
            |_ Level 3b
            |_ Level 3c
                |_ Level 4a
            |_ Level 3d
        |_ Level 2b
            |_ Level 3e
    ]
}
  
```



```

]
}
A -> B
@enduml

```

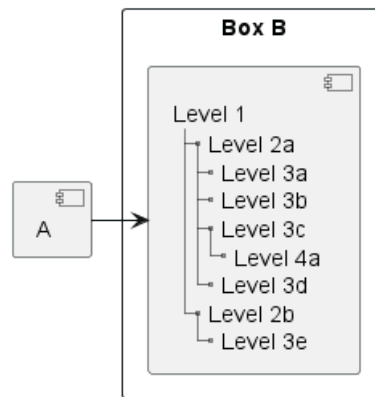

[Ref. QA-11365]

## 22.11 Special characters

It's possible to use any unicode character, either directly or with syntax `&#nnnnnn`; (decimal) or `<U+XXXXX>` (hex):

```

@startuml
usecase direct as "this is ∞ long"
usecase ampHash as "this is also ∞ long"
usecase angleBrackets as "this is also <U+221E> long"
@enduml

```

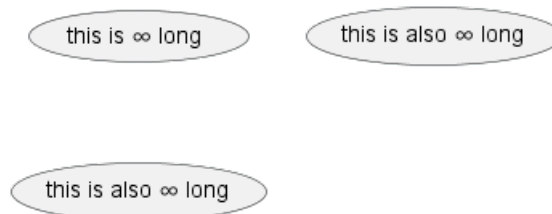

Please note that not all Unicode chars appear correctly, depending on installed fonts.

- You can use the `listfonts` command with a test string of your desired characters, to see which fonts may include them.
- For characters that are emoji, it's better to use the Emoji notation that doesn't depend on installed fonts, and the emoji are colored.
- The PlantUML server has the "Noto Emoji" font that has most emoji. If you want to render diagrams on your local system, you should check which fonts you have.
- Unfortunately "Noto Emoji" lacks normal chars, so you need to switch fonts, eg

```

@startuml
rectangle "<font:Noto Emoji><U+1F3F7></font> label"
rectangle "<font:Noto Emoji><U+1F527></font> wrench"
rectangle "<font:Noto Emoji><U+1F6E0></font> hammer_and_wrench"
@enduml

```



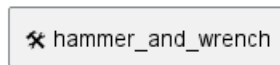

See Issue 72 for more details.

## 22.12 Legacy HTML

You can mix Creole with the following HTML tags:

- `<b>` for bold text
- `<u>` or `<u:#AAAAAA>` or `<u:[[color|colorName]]>` for underline
- `<i>` for italic
- `<s>` or `<s:#AAAAAA>` or `<s:[[color|colorName]]>` for strike text
- `<w>` or `<w:#AAAAAA>` or `<w:[[color|colorName]]>` for wave underline text
- `<plain>` for plain text
- `<color:#AAAAAA>` or `<color:[[color|colorName]]>`
- `<back:#AAAAAA>` or `<back:[[color|colorName]]>` for background color
- `<size:nn>` to change font size
- `<img:file>` : the file must be accessible by the filesystem
- `<img:http://plantuml.com/logo3.png>` : the URL must be available from the Internet

@startuml

```

:* You can change <color:red>text color</color>
* You can change <back:cadetblue>background color</back>
* You can change <size:18>size</size>
* You use <u>legacy</u> <b>HTML <i>tag</i></b>
* You use <u:red>color</u> <s:green>in HTML</s> <w:#0000FF>tag</w>
----
* Use image : <img:http://plantuml.com/logo3.png>
;
@enduml

```



## 22.12.1 Common HTML element

```

@startuml
hide footbox
note over Source
<code>
  This is <b>bold</b>
  This is <i>italics</i>
  This is <font:monospaced>monospaced</font>
  This is <s>stroked</s>
  This is <u>underlined</u>
  This is <w>waved</w>
  This is <s:green>stroked</s>
  This is <u:red>underlined</u>
  This is <w:#0000FF>waved</w>
  This is <b>a bold text containing <plain>plain text</plain> inside</b>
  -- other examples --
  This is <color:blue>Blue</color>
  This is <back:orange>Orange background</back>
  This is <size:20>big</size>
</code>
end note
/note over Output
  This is <b>bold</b>
  This is <i>italics</i>
  This is <font:monospaced>monospaced</font>
  This is <s>stroked</s>
  This is <u>underlined</u>
  This is <w>waved</w>
  This is <s:green>stroked</s>
  This is <u:red>underlined</u>
  This is <w:#0000FF>waved</w>
  This is <b>a bold text containing <plain>plain text</plain> inside</b>
  -- other examples --
  This is <color:blue>Blue</color>
  This is <back:orange>Orange background</back>
  This is <size:20>big</size>
end note
@enduml

```

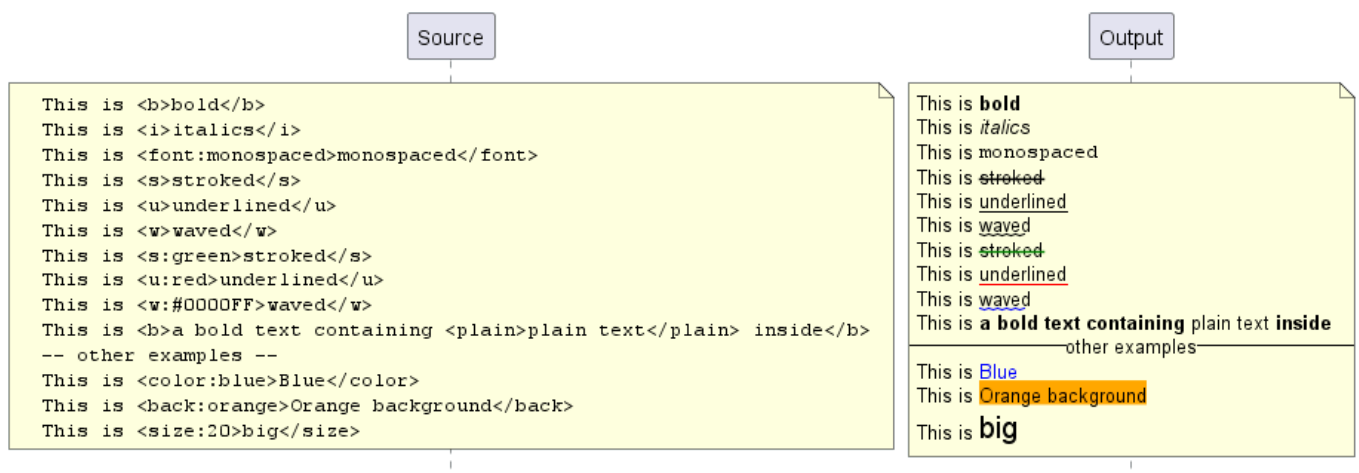

[Ref. QA-5254 for plain]



### 22.12.2 Subscript and Superscript element [sub, sup]

```
@startuml
: <code>
This is the "caffeine" molecule: C<sub>8</sub>H<sub>10</sub>N<sub>4</sub>O<sub>2</sub>
</code>
This is the "caffeine" molecule: C<sub>8</sub>H<sub>10</sub>N<sub>4</sub>O<sub>2</sub>
----
<code>
This is the Pythagorean theorem: a<sup>2</sup> + b<sup>2</sup> = c<sup>2</sup>
</code>
This is the Pythagorean theorem: a<sup>2</sup> + b<sup>2</sup> = c<sup>2</sup>;
@enduml
```

<pre>This is the "caffeine" molecule: C&lt;sub&gt;8&lt;/sub&gt;H&lt;sub&gt;10&lt;/sub&gt;N&lt;sub&gt;4&lt;/sub&gt;O&lt;sub&gt;2&lt;/sub&gt; This is the "caffeine" molecule: C<sub>8</sub>H<sub>10</sub>N<sub>4</sub>O<sub>2</sub></pre>
<pre>This is the Pythagorean theorem: a&lt;sup&gt;2&lt;/sup&gt; + b&lt;sup&gt;2&lt;/sup&gt; = c&lt;sup&gt;2&lt;/sup&gt; This is the Pythagorean theorem: a<sup>2</sup> + b<sup>2</sup> = c<sup>2</sup></pre>

## 22.13 OpenIconic

OpenIconic is a very nice open-source icon set. Those icons are integrated in the creole parser, so you can use them out-of-the-box.

Use the following syntax: `<&ICON_NAME>`.

```
@startuml
title: <size:20><&heart>Use of OpenIconic<&heart></size>
class Wifi
note left
  Click on <&wifi>
end note
@enduml
```

### ♥Use of OpenIconic♥

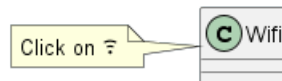

The complete list is available with the following special command:

```
@startuml
listopeniconic
@enduml
```

<b>List Open Iconic</b>	▲ bell	☁ cloud	≡ excerpt	≡ justify-right	🎵 musical-note	★ star
<i>Credit to</i>	📶 bluetooth	☁️ cloudy	⏏ expand-down	🗝 key	📎 paperclip	☀ sun
<a href="https://useiconic.com/open">https://useiconic.com/open</a>	<b>B</b> bold	📄 code	⏪ expand-left	💻 laptop	📓 pencil	📱 tablet
⇒ account-login	⚡ bolt	🧠 cog	⏩ expand-right	📂 layers	👥 people	🏷 tag
⇒ account-logout	📖 book	⏴ collapse-down	⏴ expand-up	💡 lightbulb	👤 person	🏷 tags
↶ action-redo	🔖 bookmark	⏵ collapse-left	🔗 external-link	🔗 link-broken	📞 phone	🎯 target
↷ action-undo	📦 box	⏵ collapse-right	👁 eye	🔗 link-intact	📊 pie-chart	📁 task
≡ align-center	👛 briefcase	⏴ collapse-up	👁 eyedropper	📋 list-rich	📌 pin	🖨 terminal
≡ align-left	🇬🇧 british-pound	⚙ command	📁 file	≡ list	🎮 play-circle	T text
≡ align-right	🌐 browser	■ comment-square	🔥 fire	📍 location	➕ plus	👎 thumb-down
⊗ aperture	🖌 brush	🧭 compass	🚩 flag	🔒 lock-locked	🔌 power-standby	👍 thumb-up
↓ arrow-bottom	🐛 bug	⚖ contrast	⚡ flash	🔓 lock-unlocked	🖨 print	⌚ timer
⊙ arrow-circle-bottom	📣 bullhorn	≡ copywriting	📁 folder	🔄 loop-circular	📁 project	⇄ transfer
⊙ arrow-circle-left	📊 calculator	📇 credit-card	🍴 fork	📐 loop-square	⚡ pulse	🗑 trash
⊙ arrow-circle-right	📅 calendar	📄 crop	🗑 fullscreen-enter	🔄 loop	🧩 puzzle-piece	⏟ underline
⊙ arrow-circle-top	📷 camera-slr	📊 dashboard	🗑 fullscreen-exit	🔍 magnifying-glass	❓ question-mark	⏴ vertical-align-bottom
← arrow-left	📍 caret-bottom	⬇ data-transfer-download	🌐 globe	📍 map-marker	🌧 rain	⏵ vertical-align-center
→ arrow-right	⏪ caret-left	⬆ data-transfer-upload	📊 graph	🗺 map	✖ random	⏴ vertical-align-top
↓ arrow-thick-bottom	⏩ caret-right	🗑 delete	📊 grid-four-up	⏸ media-pause	🔄 reload	📹 video
← arrow-thick-left	⬆ caret-top	📞 dial	📊 grid-three-up	▶ media-play	↔ resize-both	🔊 volume-high
→ arrow-thick-right	🛒 cart	📄 document	📊 grid-two-up	⏮ media-skip-backward	↔ resize-width	🔊 volume-low
↑ arrow-thick-top	💬 chat	💰 dollar	📁 hard-drive	⏭ media-skip-forward	📡 rss	⚠ warning
↑ arrow-top	✓ check	” double-quote-sans-left	📁 header	⏩ media-step-backward	📡 rss-alt	📶 wifi
🔊 audio-spectrum	▼ chevron-bottom	“ double-quote-sans-right	🎧 headphones	⏪ media-step-forward	📄 script	🔧 wrench
🔊 audio	◀ chevron-left	” double-quote-serif-left	♥ heart	⏩ media-step-forward	📦 share-boxed	✂ x
† badge	▶ chevron-right	” double-quote-serif-right	🏠 home	⏹ media-stop	📤 share	🇬🇧 yen
📊 ban	⬆ chevron-top	👉 droplet	🖼 image	🏥 medical-cross	🛡 shield	🔍 zoom-in
📊 bar-chart	⬆ chevron-top	📀 eject	📁 inbox	≡ menu	📶 signal	🔍 zoom-out
🛒 basket	⬆ chevron-top	🛗 elevator	∞ infinity	🔇 microphone	↑ signpost	
🔋 battery-empty	📄 clipboard	📄 ellipses	📄 info	➖ minus	↕ sort-ascending	
🔋 battery-full	🕒 clock	✉ envelope-closed	📄 italic	📺 monitor	↕ sort-descending	
🧴 beaker	☁ cloud-download	✉ envelope-open	≡ justify-center	🌙 moon	➡ move	
	☁ cloud-upload	€ euro	≡ justify-left	➡ move		

## 22.14 Appendix: Examples of "Creole List" on all diagrams

### 22.14.1 Activity

```

@startuml
start
:**test list 1**
* Bullet list
* Second item
** Sub item
*** Sub sub item
* Third item
----
**test list 2**
# Numbered list
# Second item
## Sub item
## Another sub item
# Third item;
stop
@enduml

```



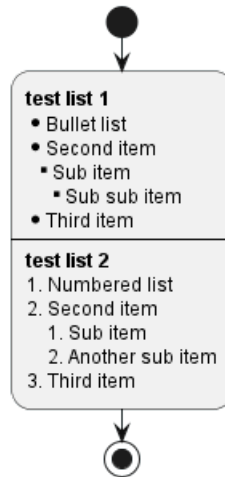

### 22.14.2 Class

TODO: FIXME

- *Sub item*
- *Sub sub item*

TODO: FIXME

@startuml

```
class a {
**test list 1**
* Bullet list
* Second item
** Sub item
*** Sub sub item
* Third item
----
**test list 2**
# Numbered list
# Second item
## Sub item
## Another sub item
# Third item
}
```

a -- b

@enduml





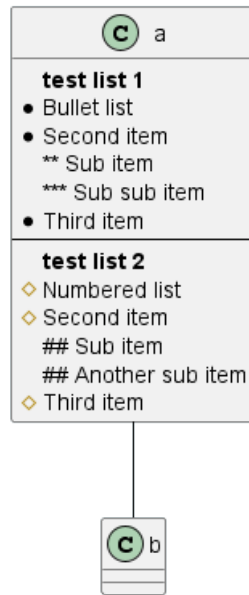

### 22.14.3 Component, Deployment, Use-Case

```

@startuml
node n [
**test list 1**
* Bullet list
* Second item
** Sub item
*** Sub sub item
* Third item
----
**test list 2**
# Numbered list
# Second item
## Sub item
## Another sub item
# Third item
]

file f as "
**test list 1**
* Bullet list
* Second item
** Sub item
*** Sub sub item
* Third item
----
**test list 2**
# Numbered list
# Second item
## Sub item
## Another sub item
# Third item
"
@enduml

```



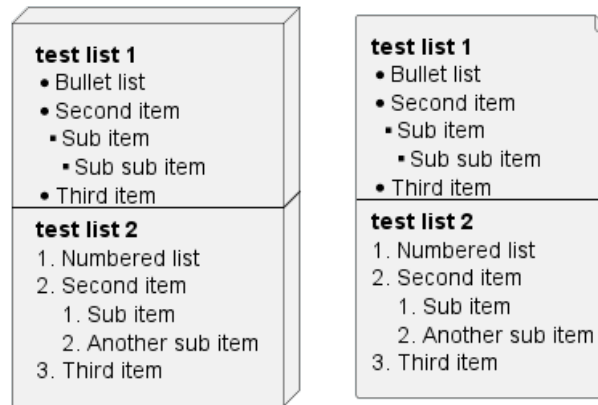

**TODO:** DONE [Corrected in V1.2020.18]

#### 22.14.4 Gantt project planning

N/A

#### 22.14.5 Object

**TODO:** FIXME

- *Sub item*
- *Sub sub item*

**TODO:** FIXME

```
@startuml
object user {
**test list 1**
* Bullet list
* Second item
** Sub item
*** Sub sub item
* Third item
----
**test list 2**
# Numbered list
# Second item
## Sub item
## Another sub item
# Third item
}
@enduml
```

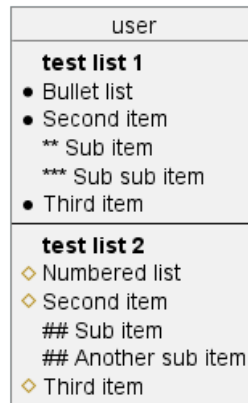

### 22.14.6 MindMap

```

@startmindmap

* root
** d1
**:**test list 1**
* Bullet list
* Second item
** Sub item
*** Sub sub item
* Third item
----
**test list 2**
# Numbered list
# Second item
## Sub item
## Another sub item
# Third item;

@endmindmap

```

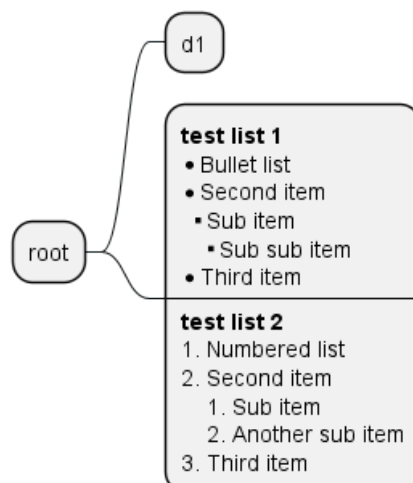

### 22.14.7 Network (nwdiag)

```

@startuml
nwdiag {

```



```

network Network {
    Server [description="**test list 1**\n* Bullet list\n* Second item\n** Sub item\n*** Sub sub i
}
@enduml

```

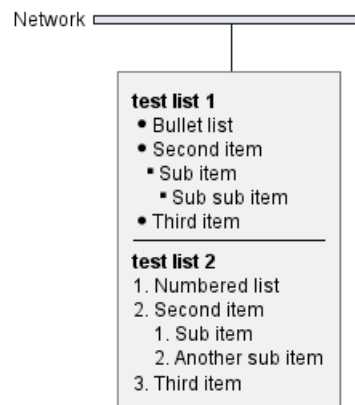

### 22.14.8 Note

```

@startuml
note as n
**test list 1**
* Bullet list
* Second item
** Sub item
*** Sub sub item
* Third item
----
**test list 2**
# Numbered list
# Second item
## Sub item
## Another sub item
# Third item
end note
@enduml

```

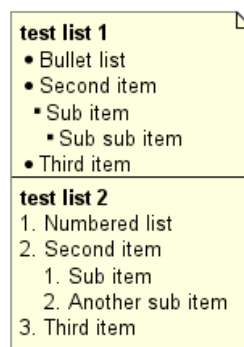

### 22.14.9 Sequence

```

@startuml
<style>
participant {HorizontalAlignment left}
</style>

```



```

participant Participant [
**test list 1**
* Bullet list
* Second item
** Sub item
*** Sub sub item
* Third item
----
**test list 2**
# Numbered list
# Second item
## Sub item
## Another sub item
# Third item
]

participant B

Participant -> B
@enduml

```

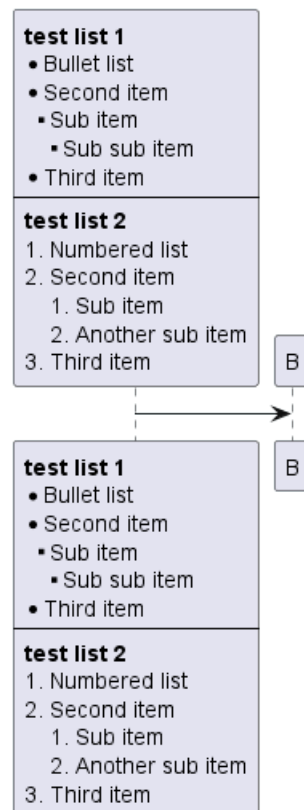

[Ref. QA-15232]

### 22.14.10 State

```

@startuml
<style>
stateDiagram {
title {HorizontalAlignment left}
}
</style>
state "**test list 1**\n* Bullet list\n* Second item\n** Sub item\n*** Sub sub item\n* Third item\n-
state "**test list 1**\n* Bullet list\n* Second item\n** Sub item\n*** Sub sub item\n* Third item\n-

```



```
state : **test list 1**\n* Bullet list\n* Second item\n** Sub item\n*** Sub sub item\n* Third item\n}
@enduml
```

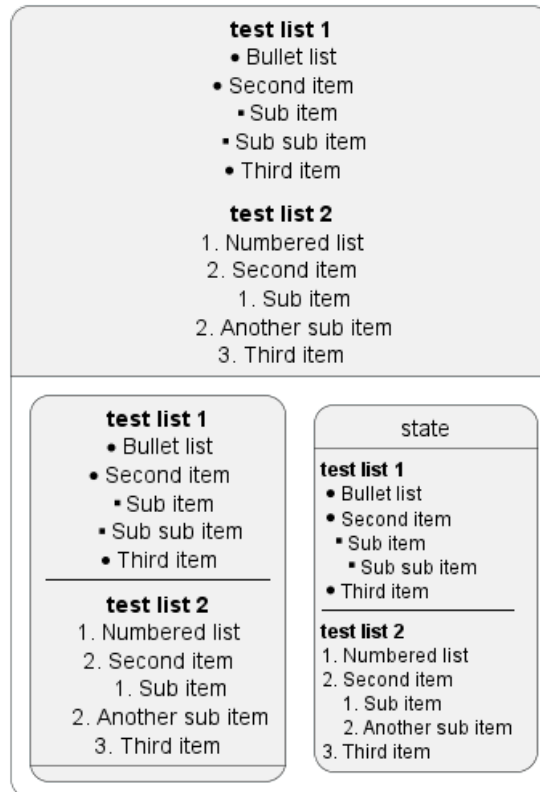

[Ref. QA-16978]

### 22.14.11 WBS

```
@startwbs

* root
** d1
**:**test list 1**
* Bullet list
* Second item
** Sub item
*** Sub sub item
* Third item
----
**test list 2**
# Numbered list
# Second item
## Sub item
## Another sub item
# Third item;

@endwbs
```



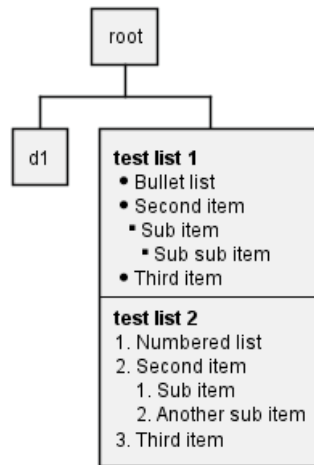

## 22.15 Appendix: Examples of "Creole horizontal lines" on all diagrams

### 22.15.1 Activity

TODO: FIXME strong line \_\_\_\_ TODO: FIXME

```
@startuml
start
:You can have horizontal line
----
Or double line
====
Or strong line
-----
Or dotted line
..My title..
Or dotted title
//and title... //
==Title==
Or double-line title
--Another title--
Or single-line title
Enjoy!;
stop
@enduml
```

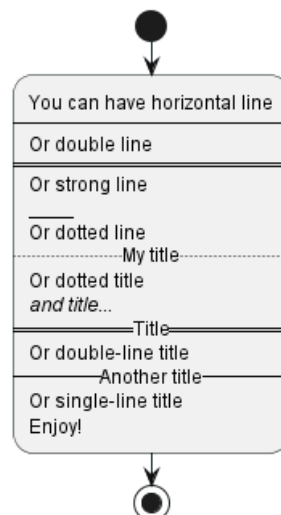

### 22.15.2 Class

```

@startuml

class a {
You can have horizontal line
----
Or double line
=====
Or strong line
-----
Or dotted line
..My title..
Or dotted title
//and title... //
==Title==
Or double-line title
--Another title--
Or single-line title
Enjoy!
}

a -- b

@enduml

```

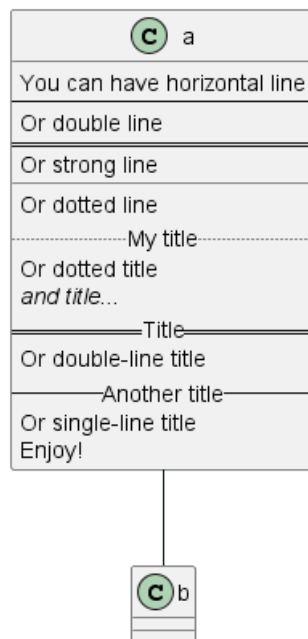

### 22.15.3 Component, Deployment, Use-Case

```

@startuml

node n [
You can have horizontal line
----
Or double line
=====
Or strong line
-----
Or dotted line
..My title..
]

@enduml

```





```
//and title... //
==Title==
--Another title--
Enjoy!
]

file f as "
You can have horizontal line
----
Or double line
====
Or strong line
----
Or dotted line
..My title..
//and title... //
==Title==
--Another title--
Enjoy!
"

person p [

You can have horizontal line
----
Or double line
====
Or strong line
----
Or dotted line
..My title..
//and title... //
==Title==
--Another title--
Enjoy!

]
@enduml
```

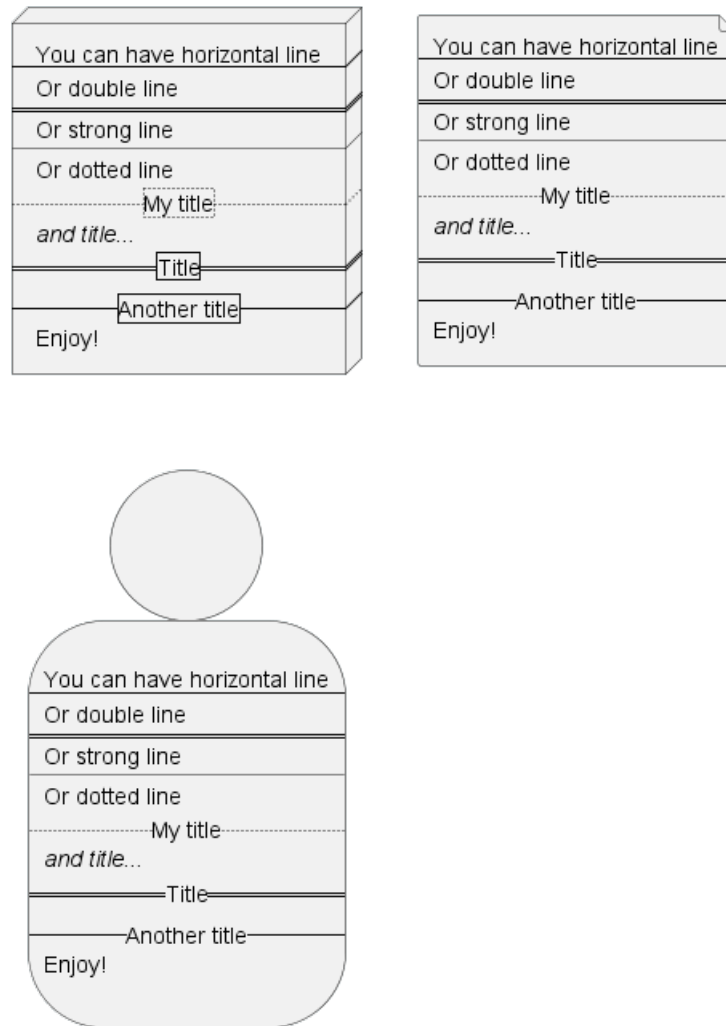

#### 22.15.4 Gantt project planning

N/A

#### 22.15.5 Object

```
@startuml
object user {
You can have horizontal line
----
Or double line
====
Or strong line
-----
Or dotted line
..My title..
//and title... //
==Title==
--Another title--
Enjoy!
}

@enduml
```

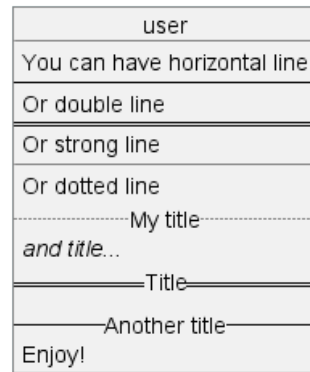

**TODO:** DONE [Corrected on V1.2020.18]

### 22.15.6 MindMap

**TODO:** FIXME strong line \_\_\_\_ **TODO:** FIXME

@startmindmap

```
* root
** d1
** :You can have horizontal line
----
Or double line
====
Or strong line
----
Or dotted line
..My title..
//and title... //
==Title==
--Another title--
Enjoy!;
```

@endmindmap

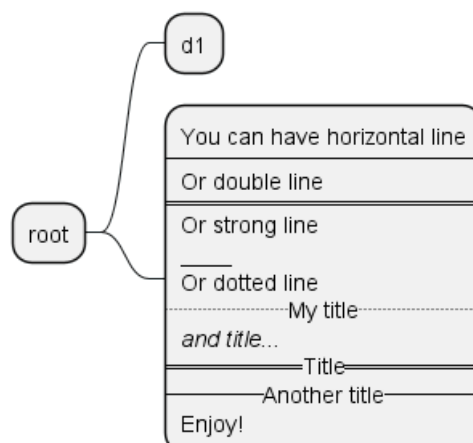

### 22.15.7 Network (nwdiag)

```
@startuml
nwdiag {
  network Network {
```



```

    Server [description="You can have horizontal line\n----\nOr double line\n====\nOr strong line\n-----\nOr dotted line\n.....\nand title...\n==Title==\n--Another title--\nEnjoy!"]
}
@enduml

```

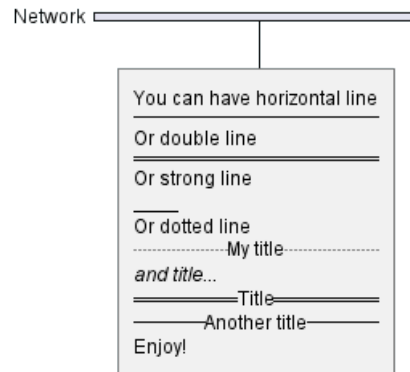

### 22.15.8 Note

```

@startuml
note as n
You can have horizontal line
----
Or double line
====
Or strong line
-----
Or dotted line
.....
..My title..
//and title... //
==Title==
--Another title--
Enjoy!
end note
@enduml

```

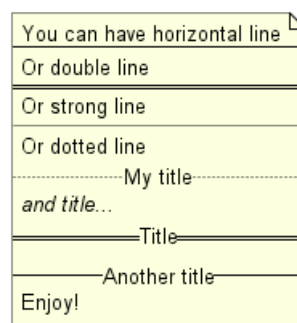

### 22.15.9 Sequence

```

@startuml
<style>
participant {HorizontalAlignment left}
</style>
participant Participant [
You can have horizontal line
----
Or double line

```



```

====
Or strong line
----
Or dotted line
..My title..
//and title... //
==Title==
--Another title--
Enjoy!
]

participant B

Participant -> B
@enduml

```

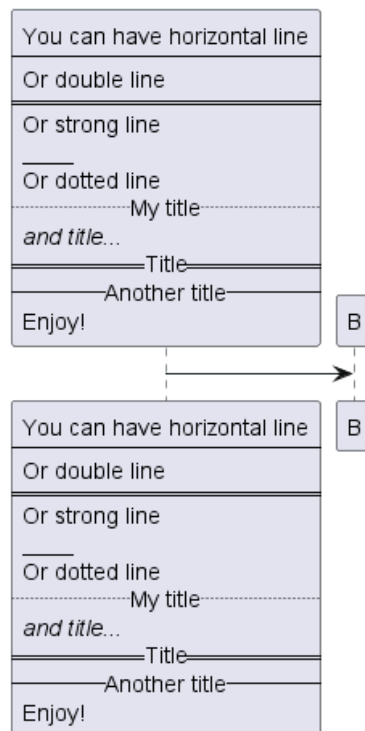

[Ref. QA-15232]

### 22.15.10 State

```

@startuml
<style>
stateDiagram {
title {HorizontalAlignment left}
}
</style>
state "You can have horizontal line\n----\nOr double line\n====\nOr strong line\n____\nOr dotted line"
state "You can have horizontal line\n----\nOr double line\n====\nOr strong line\n____\nOr dotted line"
state : "You can have horizontal line\n----\nOr double line\n====\nOr strong line\n____\nOr dotted line"
}
@enduml

```



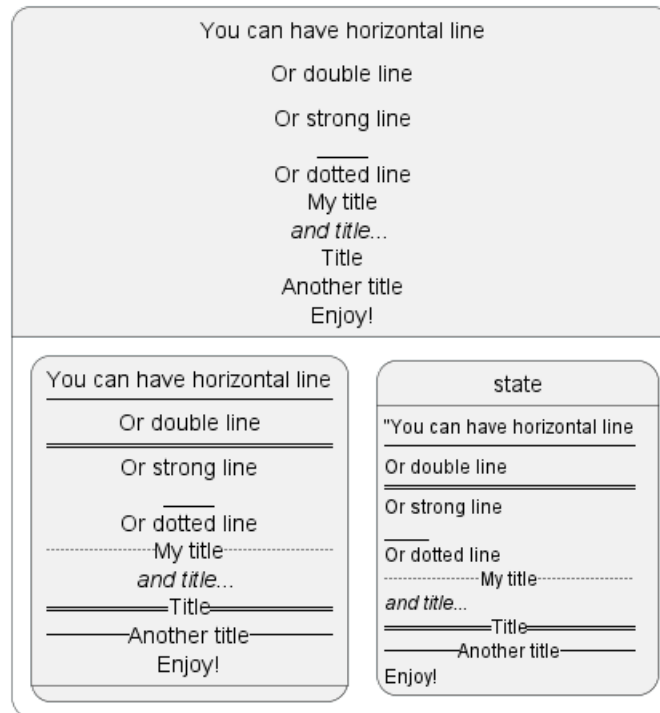

[Ref. QA-16978]

### 22.15.11 WBS

**TODO:** FIXME strong line \_\_\_\_ **TODO:** FIXME

@startwbs

```
* root
** d1
** :You can have horizontal line
----
Or double line
====
Or strong line
----
Or dotted line
..My title..
//and title... //
==Title==
--Another title--
Enjoy!;
```

@endwbs



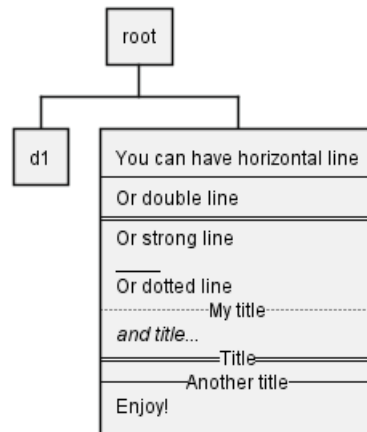

## 22.16 Style equivalent (between Creole and HTML)

Style	Creole	Legacy HTML like
<b>bold</b>	This is <b>bold</b>	This is <b>bold</b>
<i>italics</i>	This is //italics//	This is <i>italics</i>
monospaced	This is "monospaced"	This is <font:monospaced>monospaced</font>
stroked	This is --stroked--	This is <s>stroked</s>
<u>underlined</u>	This is __underlined__	This is <u>underlined</u>
waved	This is ~~~	This is <w>waved</w>

```
@startmindmap
```

```
* Style equivalent\n(between Creole and HTML)
```

```
**:**Creole**
```

```
----
```

```
<#silver>|= code|= output|
```

```
| \n This is ""~**bold**""\n | \n This is bold |
| \n This is ""~//italics//""\n | \n This is //italics// |
| \n This is ""~"monospaced~"" ""\n | \n This is "monospaced" |
| \n This is ""~--stroked--""\n | \n This is --stroked-- |
| \n This is ""~__underlined__""\n | \n This is __underlined__ |
| \n This is ""<U+007E><U+007E>waved<U+007E><U+007E>""\n | \n This is ~waved~ |;
**:<b>Legacy HTML like
```

```
----
```

```
<#silver>|= code|= output|
```

```
| \n This is ""~<b>bold</b>""\n | \n This is <b>bold</b> |
| \n This is ""~<i>italics</i>""\n | \n This is <i>italics</i> |
| \n This is ""~<font:monospaced>monospaced</font>""\n | \n This is <font:monospaced>monospaced</font> |
| \n This is ""~<s>stroked</s>""\n | \n This is <s>stroked</s> |
| \n This is ""~<u>underlined</u>""\n | \n This is <u>underlined</u> |
| \n This is ""~<w>waved</w>""\n | \n This is <w>waved</w> |
```

```
And color as a bonus...
```

```
<#silver>|= code|= output|
```

```
| \n This is ""~<s:""green"">stroked</s>""\n | \n This is <s:green>stroked</s> |
| \n This is ""~<u:""red"">underlined</u>""\n | \n This is <u:red>underlined</u> |
| \n This is ""~<w:""#0000FF"">waved</w>""\n | \n This is <w:#0000FF>waved</w> |
```

```
@endmindmap
```



Style equivalent  
(between Creole and HTML)

Creole	
code	output
This is <b>**bold**</b>	This is <b>bold</b>
This is <i>//italics//</i>	This is <i>italics</i>
This is <code>"monospaced"</code>	This is monospaced
This is <del>--stoked--</del>	This is <del>stoked</del>
This is <u>__underlined__</u>	This is <u>underlined</u>
This is <u>~waved~</u>	This is <u>waved</u>

Legacy HTML like	
code	output
This is <code>&lt;b&gt;bold&lt;/b&gt;</code>	This is <b>bold</b>
This is <code>&lt;i&gt;italics&lt;/i&gt;</code>	This is <i>italics</i>
This is <code>&lt;font:monospaced&gt;monospaced&lt;/font&gt;</code>	This is monospaced
This is <code>&lt;s&gt;stoked&lt;/s&gt;</code>	This is <del>stoked</del>
This is <code>&lt;u&gt;underlined&lt;/u&gt;</code>	This is <u>underlined</u>
This is <code>&lt;w&gt;waved&lt;/w&gt;</code>	This is <u>waved</u>

And color as a bonus...

code	output
This is <code>&lt;s:green&gt;stoked&lt;/s&gt;</code>	This is <del>stoked</del>
This is <code>&lt;u:red&gt;underlined&lt;/u&gt;</code>	This is <u>underlined</u>
This is <code>&lt;w:#0000FF&gt;waved&lt;/w&gt;</code>	This is <u>waved</u>



## 23 Defining and using sprites

A *Sprite* is a small graphic element that can be used in diagrams.

In PlantUML, sprites are monochrome and can have either 4, 8 or 16 gray level.

To define a sprite, you have to use a hexadecimal digit between 0 and F per pixel.

Then you can use the sprite using `<$XXX>` where XXX is the name of the sprite.

```
@startuml
sprite $foo1 {
  FFFFFFFFFFFFFFFF
  F0123456789ABCF
  F0123456789ABCF
  F0123456789ABCF
  F0123456789ABCF
  F0123456789ABCF
  F0123456789ABCF
  F0123456789ABCF
  F0123456789ABCF
  F0123456789ABCF
  F0123456789ABCF
  FFFFFFFFFFFFFFFF
}
Alice -> Bob : Testing <$foo1>
@enduml
```

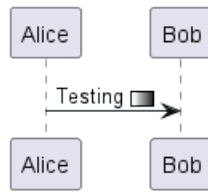

You can scale the sprite.

```
@startuml
sprite $foo1 {
  FFFFFFFFFFFFFFFF
  F0123456789ABCF
  F0123456789ABCF
  F0123456789ABCF
  F0123456789ABCF
  F0123456789ABCF
  F0123456789ABCF
  F0123456789ABCF
  F0123456789ABCF
  F0123456789ABCF
  FFFFFFFFFFFFFFFF
}
Alice -> Bob : Testing <$foo1{scale=3}>
@enduml
```

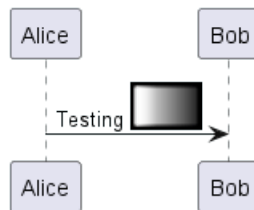

## 23.1 Inline SVG sprite

You can also use inlined SVG for sprites. Only a tiny subset of SVG directives is possible, so you probably have to compress existing SVG files using <https://vecta.io/nano>.

```
@startuml
sprite foo1 <svg width="8" height="8" viewBox="0 0 8 8"><path d="M1 0l-1 1 1.5 1.5-1.5 1.5h4v-4l-1.5
Alice->Bob : <$foo1*3>
@enduml
```

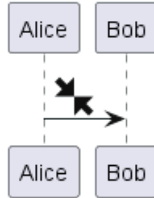

Another example:

```
@startuml
sprite foo1 <svg viewBox="0 0 36 36">
<path fill="#77B255" d="M36 32c0 2.209-1.791 4-4 4H4c-2.209 0-4-1.791-4-4V4c0-2.209 1.791-4 4-4h28c2
<path fill="#FFF" d="M21.529 18.006l8.238-8.238c.977-.977.977-2.559 0-3.535-.977-.977-2.559-.977-3.535
</svg>
Alice->Bob : <$foo1>
@enduml
```

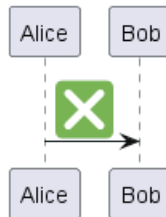

## 23.2 Changing colors

Although sprites are monochrome, it's possible to change their color.

```
@startuml
sprite $foo1 {
FFFFFFFFFFFFFFFF
F0123456789ABCF
F0123456789ABCF
F0123456789ABCF
F0123456789ABCF
F0123456789ABCF
F0123456789ABCF
F0123456789ABCF
F0123456789ABCF
F0123456789ABCF
FFFFFFFFFFFFFFFF
}
Alice -> Bob : Testing <$foo1,scale=3.4,color=orange>
@enduml
```

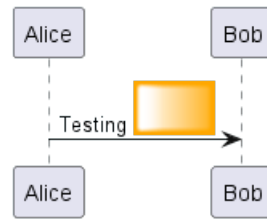

### 23.3 Encoding Sprite

To encode sprite, you can use the command line like:

```
java -jar plantuml.jar -encodesprite 16z foo.png
```

where `foo.png` is the image file you want to use (it will be converted to gray automatically).

After `-encodesprite`, you have to specify a format: `4`, `8`, `16`, `4z`, `8z` or `16z`.

The number indicates the gray level and the optional `z` is used to enable compression in sprite definition.

### 23.4 Importing Sprite

You can also launch the GUI to generate a sprite from an existing image.

Click in the menubar then on `File/Open Sprite Window`.

After copying an image into you clipboard, several possible definitions of the corresponding sprite will be displayed : you will just have to pickup the one you want.

### 23.5 Examples

```
@startuml
sprite $printer [15x15/8z] N0tH3WOW208HxFz_kMAhj7lHWpa1XC716sz0Pq4MVPEWfBHIuxP3L6kbTcizR8tAhzaqFvXwv
start
:click on <$printer> to print the page;
@enduml
```



```
@startuml
sprite $bug [15x15/16z] PKzR2i0m2BFMi15p__FEjQEgB1z27aeqCqixa8S40T7C53cKpsHpaYPDJY_12MHM-BLRyywPhrr
sprite $printer [15x15/8z] N0tH3WOW208HxFz_kMAhj7lHWpa1XC716sz0Pq4MVPEWfBHIuxP3L6kbTcizR8tAhzaqFvXwv
sprite $disk {
  444445566677881
  43600000009991
  4360000000ACA1
  53700000001A7A1
  537000000012B8A1
  5380000000123B8A1
  638000001233C9A1
  634999AABBC99B1
  744566778899AB1
  7456AAAAA99AAB1
  8566AFC228AABB1
  8567AC8118BBBB1
  867BD4433BBBBB1
  39AAAAABBBBBBC1
}
}
```

```

title Use of sprites (<$printer>, <$bug>...)

class Example {
Can have some bug : <$bug>
Click on <$disk> to save
}

note left : The printer <$printer> is available

@enduml

```



## 23.6 StdLib

The PlantUML StdLib includes a number of ready icons in various IT areas such as architecture, cloud services, logos etc. It including AWS, Azure, Kubernetes, C4, product Logos and many others. To explore these libraries:

- Browse the Github folders of PlantUML StdLib
- Browse the source repos of StdLib collections that interest you. Eg if you are interested in logos you can find that it came from gilbarbara-plantuml-sprites, and quickly find its

sprites-list. (The next section shows how to list selected sprites but unfortunately that's in grayscale whereas this custom listing is in color.)

- Study the in-depth Hitchhiker' s Guide to PlantUML, eg sections Standard Library Sprites and PlantUML Stdlib Overview

## 23.7 Listing Sprites

You can use the `listsprites` command to show available sprites:

- Used on its own, it just shows ArchiMate sprites
- If you include some sprite libraries in your diagram, the command shows all these sprites, as explained in View all the icons with listsprites.

(Example from Hitchhikers Guide to PlantUML)

```

@startuml
!define osaPuml https://raw.githubusercontent.com/Crashedmind/PlantUML-opensecurityarchitecture2-ico
!include osaPuml/Common.puml
!include osaPuml/User/all.puml
!include osaPuml/Hardware/all.puml
!include osaPuml/Misc/all.puml
!include osaPuml/Server/all.puml
!include osaPuml/Site/all.puml

listsprites

' From The Hitchhiker' s Guide to PlantUML
@enduml

```





Most collections have files called `all` that allow you to see a whole sub-collection at once. Else you need to find the sprites that interest you and include them one by one. Unfortunately, the version of a collection included in StdLib often does not have such `all` files, so as you see above we include the collection from github, not from StdLib.

All sprites are in grayscale, but most collections define specific macros that include appropriate (vendor-specific) colors.

## 24 Skinparam command

You can change colors and font of the drawing using the `skinparam` command.

Example:

```
skinparam backgroundColor transparent
```

### 24.1 Usage

You can use this command :

- In the diagram definition, like any other commands,
- In an included file,
- In a configuration file, provided in the command line or the ANT task.

### 24.2 Nested

To avoid repetition, it is possible to nest definition. So the following definition :

```
skinparam xxxxParam1 value1
skinparam xxxxParam2 value2
skinparam xxxxParam3 value3
skinparam xxxxParam4 value4
```

is strictly equivalent to:

```
skinparam xxxx {
    Param1 value1
    Param2 value2
    Param3 value3
    Param4 value4
}
```

### 24.3 Black and White

You can force the use of a black&white output using `skinparam monochrome true` command.

```
@startuml

skinparam monochrome true

actor User
participant "First Class" as A
participant "Second Class" as B
participant "Last Class" as C

User -> A: DoWork
activate A

A -> B: Create Request
activate B

B -> C: DoWork
activate C
C --> B: WorkDone
destroy C

B --> A: Request Created
deactivate B
```



```

A --> User: Done
deactivate A

@enduml

```

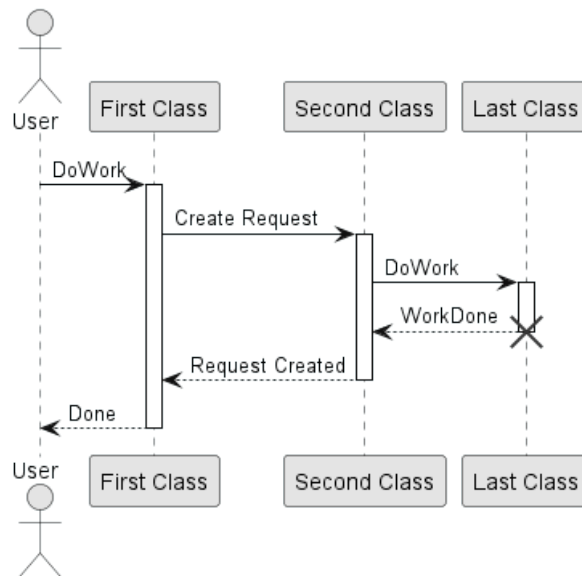

## 24.4 Shadowing

You can disable the shadowing using the `skinparam shadowing false` command.

```

@startuml

left to right direction

skinparam shadowing<<no_shadow>> false
skinparam shadowing<<with_shadow>> true

actor User
(Glowing use case) <<with_shadow>> as guc
(Flat use case) <<no_shadow>> as fuc
User -- guc
User -- fuc

@enduml

```

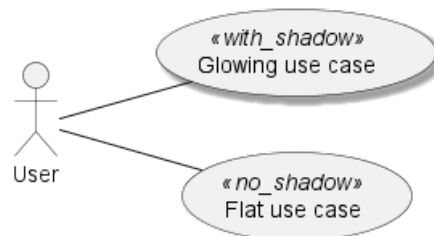

## 24.5 Reverse colors

You can force the use of a black&white output using `skinparam monochrome reverse` command. This can be useful for black background environment.

```

@startuml

skinparam monochrome reverse

```



```

actor User
participant "First Class" as A
participant "Second Class" as B
participant "Last Class" as C

User -> A: DoWork
activate A

A -> B: Create Request
activate B

B -> C: DoWork
activate C
C --> B: WorkDone
destroy C

B --> A: Request Created
deactivate B

A --> User: Done
deactivate A

@enduml

```

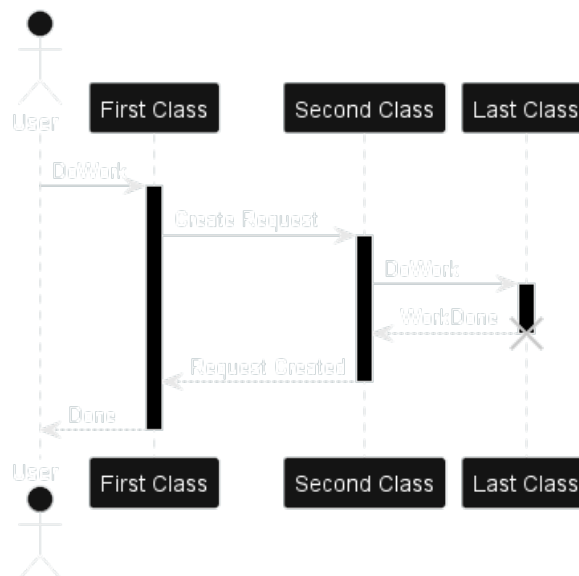

## 24.6 Colors

You can use either standard color name or RGB code.

```

@startuml
colors
@enduml

```



APPLICATION	Crimson	DeepPink	Indigo	LightYellow	Navy	RoyalBlue	Turquoise
AliceBlue	Cyan	DeepSkyBlue	Ivory	Lime	OldLace	STRATEGY	Violet
AntiqueWhite	DarkBlue	DimGray	Khaki	LimeGreen	Olive	SaddleBrown	Wheat
Aqua	DarkCyan	DimGrey	Lavender	Linen	OliveDrab	Salmon	White
Aquamarine	DarkGoldenRod	DodgerBlue	LavenderBlush	MOTIVATION	Orange	SandyBrown	WhiteSmoke
Azure	DarkGray	FireBrick	LawnGreen	Magenta	OrangeRed	SeaGreen	Yellow
BUSINESS	DarkGreen	FloralWhite	LemonChiffon	Maroon	Orchid	SeaShell	YellowGreen
Beige	DarkGrey	ForestGreen	LightBlue	MediumAquaMarine	PHYSICAL	Sienna	
Bisque	DarkKhaki	Fuchsia	LightCoral	MediumBlue	PaleGoldenRod	Silver	
Black	DarkMagenta	Gainsboro	LightCyan	MediumOrchid	PaleGreen	SkyBlue	
BlanchedAlmond	DarkOliveGreen	GhostWhite	LightGoldenRodYellow	MediumPurple	PaleTurquoise	SlateBlue	
Blue	DarkOrchid	Gold	LightGray	MediumSeaGreen	PaleVioletRed	SlateGray	
BlueViolet	DarkRed	GoldenRod	LightGreen	MediumSlateBlue	PapayaWhip	SlateGrey	
Brown	DarkSalmon	Gray	LightGrey	MediumSpringGreen	PeachPuff	Snow	
BurlyWood	DarkSeaGreen	Green	LightPink	MediumTurquoise	Peru	SpringGreen	
CadetBlue	DarkSlateBlue	GreenYellow	LightSalmon	MediumVioletRed	Pink	SteelBlue	
Chartreuse	DarkSlateGray	Grey	LightSeaGreen	MidnightBlue	Plum	TECHNOLOGY	
Chocolate	DarkSlateGrey	HoneyDew	LightSkyBlue	MintCream	PowderBlue	Tan	
Coral	DarkTurquoise	HotPink	LightSlateGray	MistyRose	Purple	Teal	
CornflowerBlue	DarkViolet	IMPLEMENTATION	LightSlateGrey	Moccasin	Red	Thistle	
Cornsilk	Darkorange	IndianRed	LightSteelBlue	NavajoWhite	RosyBrown	Tomato	

transparent can only be used for background of the image.

## 24.7 Font color, name and size

You can change the font for the drawing using `xxxFontColor`, `xxxFontSize` and `xxxFontName` parameters.

Example:

```
skinparam classFontColor red
skinparam classFontSize 10
skinparam classFontName Aapex
```

You can also change the default font for all fonts using `skinparam defaultFontName`.

Example:

```
skinparam defaultFontName Aapex
```

Please note the fontname is highly system dependent, so do not over use it, if you look for portability. Helvetica and Courier should be available on all systems.

A lot of parameters are available. You can list them using the following command:

```
java -jar plantuml.jar -language
```

## 24.8 Text Alignment

Text alignment can be set to `left`, `right` or `center` in `skinparam sequenceMessageAlign`. You can also use `direction` or `reverseDirection` values to align text depending on arrow direction.

Param name	Default value	Comment
<code>sequenceMessageAlign</code>	<code>left</code>	Used for messages in sequence diagrams
<code>sequenceReferenceAlign</code>	<code>center</code>	Used for <code>ref over</code> in sequence diagrams

```
@startuml
skinparam sequenceMessageAlign center
Alice -> Bob : Hi
Bob -> Alice : This is very long
@enduml
```



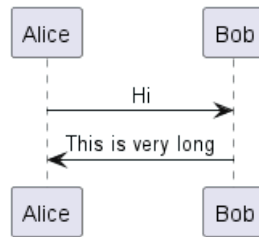

```

@startuml
skinparam sequenceMessageAlign right
Alice -> Bob : Hi
Bob -> Alice : This is very long
@enduml
  
```

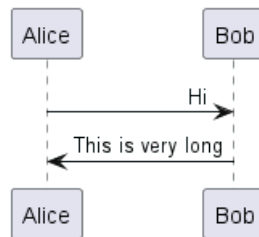

```

@startuml
skinparam sequenceMessageAlign direction
Alice -> Bob : Hi
Bob -> Alice: Hi
@enduml
  
```

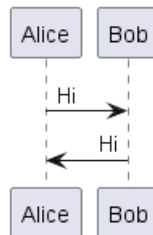

## 24.9 Examples

```

@startuml
skinparam backgroundColor #EEEBCD
skinparam handwritten true

skinparam sequence {
ArrowColor DeepSkyBlue
ActorBorderColor DeepSkyBlue
LifeLineBorderColor blue
LifeLineBackgroundColor #A9DCDF

ParticipantBorderColor DeepSkyBlue
ParticipantBackgroundColor DodgerBlue
ParticipantFontName Impact
ParticipantFontSize 17
ParticipantFontColor #A9DCDF

ActorBackgroundColor aqua
ActorFontColor DeepSkyBlue
ActorFontSize 17
ActorFontName Aapex
  
```



```

}

actor User
participant "First Class" as A
participant "Second Class" as B
participant "Last Class" as C

User -> A: DoWork
activate A

A -> B: Create Request
activate B

B -> C: DoWork
activate C
C --> B: WorkDone
destroy C

B --> A: Request Created
deactivate B

A --> User: Done
deactivate A
@enduml

```

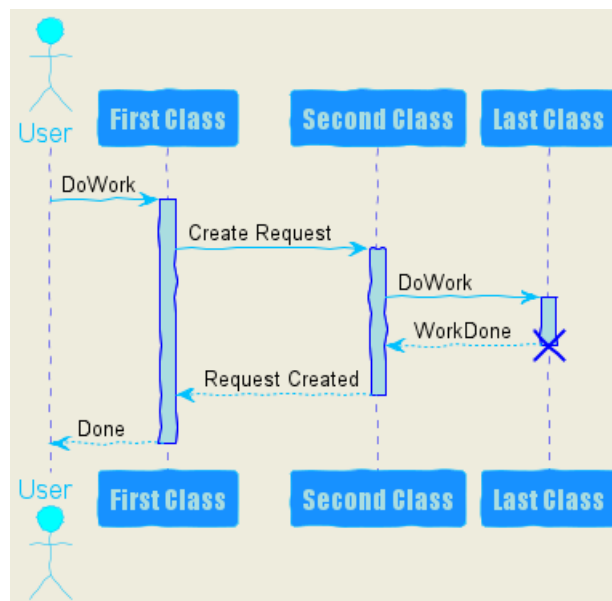

```

@startuml
skinparam handwritten true

skinparam actor {
  BorderColor black
  FontName Courier
  BackgroundColor<< Human >> Gold
}

skinparam usecase {
  BackgroundColor DarkSeaGreen
  BorderColor DarkSlateGray
}

BackgroundColor<< Main >> YellowGreen

```

```

BorderColor<< Main >> YellowGreen

ArrowColor Olive
}

User << Human >>
:Main Database: as MySql << Application >>
(Start) << One Shot >>
(Use the application) as (Use) << Main >>

User -> (Start)
User --> (Use)

MySql --> (Use)
@enduml

```

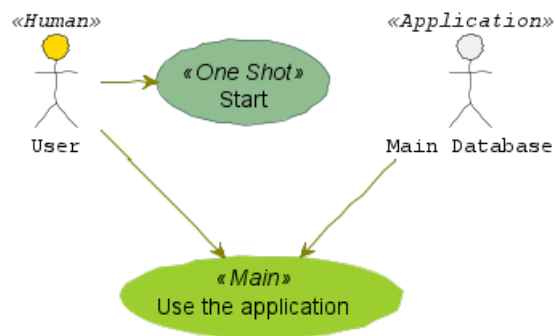

```

@startuml
skinparam roundcorner 20
skinparam class {
BackgroundColor PaleGreen
ArrowColor SeaGreen
BorderColor SpringGreen
}
skinparam stereotypeCBackgroundColor YellowGreen

```

```
Class01 "1" *-- "many" Class02 : contains
```

```
Class03 o-- Class04 : aggregation
@enduml
```

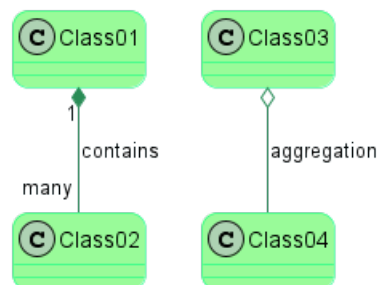

```

@startuml
skinparam interface {
backgroundColor RosyBrown
borderColor orange
}

```

```
skinparam component {
FontSize 13

```



```

BackgroundColor<<Apache>> LightCoral
BorderColor<<Apache>> #FF6655
FontName Courier
BorderColor black
BackgroundColor gold
ArrowFontName Impact
ArrowColor #FF6655
ArrowFontColor #777777
}

```

```

() "Data Access" as DA
[Web Server] << Apache >>

```

```

DA - [First Component]
[First Component] ..> () HTTP : use
HTTP - [Web Server]
@enduml

```

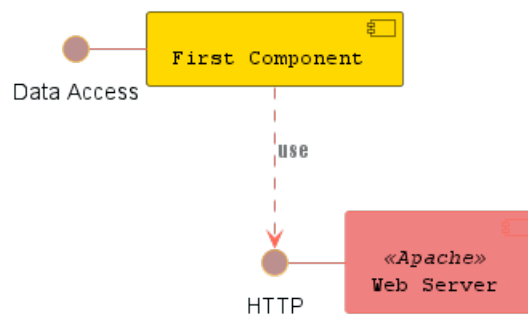

```

@startuml
[AA] <<static lib>>
[BB] <<shared lib>>
[CC] <<static lib>>

node node1
node node2 <<shared node>>
database Production

skinparam component {
    backgroundColor<<static lib>> DarkKhaki
    backgroundColor<<shared lib>> Green
}

skinparam node {
    borderColor Green
    backgroundColor Yellow
    backgroundColor<<shared node>> Magenta
}
skinparam databaseBackgroundColor Aqua
@enduml

```

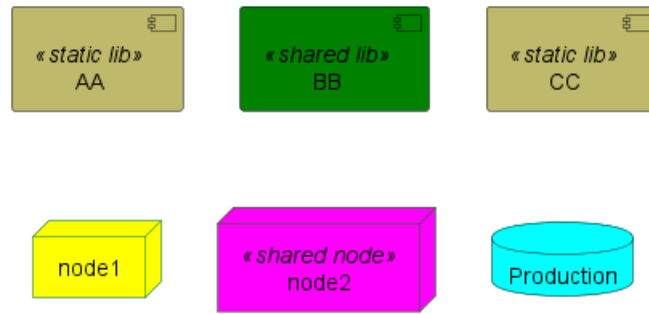

## 24.10 List of all skinparam parameters

You can use `-language` on the command line or generate a "diagram" with a list of all the skinparam parameters using :

- `help skinparams`
- `skinparameters`

### 24.10.1 Command Line: `-language` command

Since the documentation is not always up to date, you can have the complete list of parameters using this command:

```
java -jar plantuml.jar -language
```

### 24.10.2 Command: `help skinparams`

That will give you the following result, from this page (*code of this command*): `CommandHelpSkinparam.java`

```
@startuml
help skinparams
@enduml
```

#### Welcome to PlantUML!

You can start with a simple UML Diagram like:

```
Bob->Alice: Hello
```

Or

```
class Example
```

You will find more information about PlantUML syntax on <https://plantuml.com>

(Details by typing `license` keyword)



```
PlantUML 1.2023.11
```

```
[From string (line 2) ]
```

```
@startuml
help skinparams
Syntax Error?
```

### 24.10.3 Command: `skinparameters`

```
@startuml
skinparameters
@enduml
```



ActivityBackgroundColor	ClassFontSize	FolderStereoTypeFontSize	NoteFontSize	SequenceDelayFontName
ActivityBorderColor	ClassStereoTypeFontSize	FolderStereoTypeFontStyle	NoteShadowing	SequenceDelayFontSize
ActivityBorderThickness	ClassStereoTypeFontName	FooterFontColor	NoteTextAlignment	SequenceDelayFontStyle
ActivityDiamondFontColor	ClassStereoTypeFontSize	FooterFontName	ObjectAttributeFontColor	SequenceDividerBorderThickness
ActivityDiamondFontName	ClassStereoTypeFontStyle	FooterFontSize	ObjectAttributeFontName	SequenceDividerFontColor
ActivityDiamondFontSize	CloudFontColor	FooterFontStyle	ObjectAttributeFontSize	SequenceDividerFontName
ActivityDiamondFontStyle	CloudFontName	FrameFontColor	ObjectAttributeFontStyle	SequenceDividerFontSize
ActivityFontColor	CloudFontSize	FrameFontName	ObjectBorderThickness	SequenceDividerFontStyle
ActivityFontName	CloudFontStyle	FrameFontSize	ObjectFontColor	SequenceGroupBodyBackgroundColor
ActivityFontSize	CloudStereoTypeFontColor	FrameFontStyle	ObjectFontName	SequenceGroupBorderThickness
ActivityFontStyle	CloudStereoTypeFontName	FrameStereoTypeFontColor	ObjectFontSize	SequenceGroupFontColor
ActorBackgroundColor	CloudStereoTypeFontStyle	FrameStereoTypeFontName	ObjectFontStyle	SequenceGroupFontName
ActorBorderColor	CloudStereoTypeFontStyle	FrameStereoTypeFontSize	ObjectStereoTypeFontColor	SequenceGroupFontSize
ActorFontColor	ColorArrowSeparationSpace	FrameStereoTypeFontStyle	ObjectStereoTypeFontName	SequenceGroupFontStyle
ActorFontName	ComponentBorderThickness	GenericDisplay	ObjectStereoTypeFontSize	SequenceGroupHeaderFontColor
ActorFontSize	ComponentFontColor	Guillemet	ObjectStereoTypeFontStyle	SequenceGroupHeaderFontName
ActorFontStyle	ComponentFontName	Handwritten	PackageBorderThickness	SequenceGroupHeaderFontSize
ActorStereoTypeFontColor	ComponentFontSize	HeaderFontColor	PackageFontColor	SequenceGroupHeaderFontStyle
ActorStereoTypeFontName	ComponentFontStyle	HeaderFontName	PackageFontName	SequenceLifeLineBorderColor
ActorStereoTypeFontSize	ComponentStereoTypeFontColor	HeaderFontSize	PackageFontSize	SequenceLifeLineBorderThickness
ActorStereoTypeFontStyle	ComponentStereoTypeFontName	HeaderFontStyle	PackageFontStyle	SequenceMessageAlignment
AgentBorderThickness	ComponentStereoTypeFontSize	HexagonBorderThickness	PackageStereoTypeFontColor	SequenceMessageTextAlignment
AgentFontColor	ComponentStereoTypeFontStyle	HexagonFontColor	PackageStereoTypeFontName	SequenceNewpageSeparatorColor
AgentFontName	ComponentStyle	HexagonFontName	PackageStereoTypeFontSize	SequenceParticipant
AgentFontSize	ConditionEndStyle	HexagonFontSize	PackageStereoTypeFontStyle	SequenceParticipantBorderThickness
AgentFontStyle	ConditionStyle	HexagonFontStyle	PackageStyle	SequenceReferenceAlignment
AgentStereoTypeFontColor	ControlFontColor	HexagonStereoTypeFontColor	PackageTitleAlignment	SequenceReferenceBackgroundColor
AgentStereoTypeFontName	ControlFontName	HexagonStereoTypeFontName	Padding	SequenceReferenceBorderThickness
AgentStereoTypeFontSize	ControlFontSize	HexagonStereoTypeFontSize	PageBorderColor	SequenceReferenceColor
AgentStereoTypeFontStyle	ControlFontStyle	HexagonStereoTypeFontStyle	PageExternalColor	SequenceReferenceFontName
ArchimateBorderThickness	ControlStereoTypeFontColor	HyperlinkColor	PageMargin	SequenceReferenceFontSize
ArchimateFontColor	ControlStereoTypeFontName	HyperlinkUnderline	ParticipantFontColor	SequenceReferenceFontStyle
ArchimateFontName	ControlStereoTypeFontSize	IconEMandatoryColor	ParticipantFontName	SequenceReferenceHeaderBackgroundColor
ArchimateFontSize	ControlStereoTypeFontStyle	IconPackageBackgroundColor	ParticipantFontSize	SequenceStereoTypeFontColor
ArchimateFontStyle	DatabaseFontColor	IconPackageColor	ParticipantFontStyle	SequenceStereoTypeFontName
ArchimateStereoTypeFontColor	DatabaseFontName	IconPrivateBackgroundColor	ParticipantPadding	SequenceStereoTypeFontSize
ArchimateStereoTypeFontName	DatabaseFontSize	IconPrivateColor	ParticipantStereoTypeFontColor	SequenceStereoTypeFontStyle
ArchimateStereoTypeFontSize	DatabaseFontStyle	IconProtectedBackgroundColor	ParticipantStereoTypeFontName	Shadowing
ArchimateStereoTypeFontStyle	DatabaseStereoTypeFontColor	IconProtectedColor	ParticipantStereoTypeFontSize	StackFontColor
ArrowFontColor	DatabaseStereoTypeFontName	IconPublicBackgroundColor	ParticipantStereoTypeFontStyle	StackFontName
ArrowFontName	DatabaseStereoTypeFontSize	IconPublicColor	PartitionBorderThickness	StackFontSize
ArrowFontSize	DatabaseStereoTypeFontStyle	InterfaceFontColor	PartitionFontColor	StackFontStyle
ArrowFontStyle	DefaultFontColor	InterfaceFontName	PartitionFontName	StackStereoTypeFontColor
ArrowHeadColor	DefaultFontName	InterfaceFontSize	PartitionFontSize	StackStereoTypeFontName
ArrowLollipopColor	DefaultFontSize	InterfaceFontStyle	PartitionFontStyle	StackStereoTypeFontSize
ArrowMessageAlignment	DefaultFontStyle	InterfaceStereoTypeFontColor	PathHoverColor	StackStereoTypeFontStyle
ArrowThickness	DefaultMonoSpacedFontName	InterfaceStereoTypeFontName	PersonBorderThickness	StateAttributeFontColor
ArtifactFontColor	DefaultTextAlignment	InterfaceStereoTypeFontSize	PersonFontColor	StateAttributeFontName
ArtifactFontName	DesignedBackgroundColor	InterfaceStereoTypeFontStyle	PersonFontName	StateAttributeFontSize
ArtifactFontSize	DesignedBorderColor	LabelFontColor	PersonFontSize	StateAttributeFontStyle
ArtifactFontStyle	DesignedDomainBorderThickness	LabelFontName	PersonFontStyle	StateBorderColor
ArtifactStereoTypeFontColor	DesignedDomainFontColor	LabelFontSize	PersonStereoTypeFontColor	StateFontColor
ArtifactStereoTypeFontName	DesignedDomainFontName	LabelFontStyle	PersonStereoTypeFontName	StateFontName
ArtifactStereoTypeFontSize	DesignedDomainFontSize	LabelStereoTypeFontColor	PersonStereoTypeFontSize	StateFontSize
ArtifactStereoTypeFontStyle	DesignedDomainFontStyle	LabelStereoTypeFontName	PersonStereoTypeFontStyle	StateFontStyle
BackgroundColor	DesignedDomainStereoTypeFontColor	LabelStereoTypeFontSize	PersonStereoTypeThickness	StateMessageAlignment
BiddableBackgroundColor	DesignedDomainStereoTypeFontName	LabelStereoTypeFontStyle	QueueFontColor	StereoTypePosition
BiddableBorderColor	DesignedDomainStereoTypeFontSize	LegendBorderThickness	QueueFontName	StorageFontColor
BoundaryFontColor	DesignedDomainStereoTypeFontStyle	LegendFontColor	QueueFontSize	StorageFontName
BoundaryFontName	DiagramBorderColor	LegendFontName	QueueFontStyle	StorageFontSize
BoundaryFontSize	DiagramBorderThickness	LegendFontStyle	QueueStereoTypeFontColor	StorageFontStyle
BoundaryFontStyle	DomainBackgroundColor	LexicalBackgroundColor	QueueStereoTypeFontName	StorageStereoTypeFontColor
BoundaryStereoTypeFontColor	DomainBorderColor	LexicalBorderThickness	QueueStereoTypeFontSize	StorageStereoTypeFontName
BoundaryStereoTypeFontName	DomainBorderThickness	LifelineStrategy	QueueStereoTypeFontStyle	StorageStereoTypeFontSize
BoundaryStereoTypeFontSize	DomainFontColor	Linetype	Ranksep	StorageStereoTypeFontStyle
BoundaryStereoTypeFontStyle	DomainFontName	MachineBackgroundColor	RectangleBorderThickness	Style
BoxPadding	DomainFontSize	MachineBorderThickness	RectangleFontColor	SvgLinkTarget
CaptionFontColor	DomainFontStyle	MachineBorderThickness	RectangleFontName	SwimlaneBorderThickness
CaptionFontName	DomainStereoTypeFontColor	MachineFontColor	RectangleFontStyle	SwimlaneTitleFontColor
CaptionFontSize	DomainStereoTypeFontName	MachineFontName	RectangleStereoTypeFontColor	SwimlaneTitleFontName
CaptionFontStyle	DomainStereoTypeFontSize	MachineFontSize	RectangleStereoTypeFontName	SwimlaneTitleFontSize
CardBorderThickness	DomainStereoTypeFontStyle	MachineFontStyle	RectangleStereoTypeFontSize	SwimlaneTitleFontStyle
CardFontColor	Dpi	MachineStereoTypeFontColor	RectangleStereoTypeFontStyle	SwimlaneWidth
CardFontName	EntityFontColor	MachineStereoTypeFontName	RequirementBackgroundColor	SwimlaneWrapTitleWidth
CardFontSize	EntityFontName	MachineStereoTypeFontSize	RequirementBorderThickness	TabSize
CardFontStyle	EntityFontStyle	MachineStereoTypeFontStyle	RequirementBorderThickness	TimingFontColor
CardStereoTypeFontColor	EntityStereoTypeFontColor	MaxAsciiMessageLength	RequirementFontColor	TimingFontName
CardStereoTypeFontName	EntityStereoTypeFontName	MaxMessageSize	RequirementFontName	TimingFontSize
CardStereoTypeFontSize	EntityStereoTypeFontSize	MinClassWidth	RequirementFontStyle	TimingFontStyle
CardStereoTypeFontStyle	EntityStereoTypeFontStyle	Monochrome	RequirementFontStyle	TitleBorderRoundCorner
CircledCharacterFontColor	FileFontColor	NodeFontColor	RequirementStereoTypeFontColor	TitleBorderThickness
CircledCharacterFontName	FileFontName	NodeFontName	RequirementStereoTypeFontName	TitleFontColor
CircledCharacterFontSize	FileFontSize	NodeFontSize	RequirementStereoTypeFontSize	TitleFontName
CircledCharacterFontStyle	FileFontStyle	NodeFontStyle	RequirementStereoTypeFontStyle	TitleFontSize
CircledCharacterRadius	FileStereoTypeFontColor	NodeStereoTypeFontColor	RequirementStereoTypeFontStyle	TitleFontStyle
ClassAttributeFontColor	FileStereoTypeFontName	NodeStereoTypeFontName	RequirementStereoTypeFontSize	UseCaseBorderThickness
ClassAttributeFontName	FileStereoTypeFontSize	NodeStereoTypeFontName	RequirementStereoTypeFontStyle	UseCaseFontColor
ClassAttributeFontSize	FileStereoTypeFontStyle	NodeStereoTypeFontStyle	RequirementStereoTypeFontSize	UseCaseFontName
ClassAttributeFontStyle	FixCircleLabelOverlapping	Nodessep	RequirementStereoTypeFontSize	UseCaseFontSize
ClassAttributeIconSize	FolderFontColor	NoteBackgroundColor	RequirementStereoTypeFontSize	UseCaseFontStyle
ClassBackgroundColor	FolderFontName	NoteBorderThickness	RequirementStereoTypeFontSize	UseCaseStereoTypeFontColor
ClassBorderColor	FolderFontSize	NoteFontColor	RequirementStereoTypeFontSize	UseCaseStereoTypeFontName
ClassBorderThickness	FolderFontStyle	NoteFontName	RequirementStereoTypeFontSize	UseCaseStereoTypeFontSize
ClassFontColor	FolderStereoTypeFontColor	NoteFontStyle	RequirementStereoTypeFontSize	UseCaseStereoTypeFontStyle
ClassFontName	FolderStereoTypeFontName	NoteFontSize	RequirementStereoTypeFontSize	WrapWidth
ClassFontSize	FolderStereoTypeFontName	NoteFontStyle	RequirementStereoTypeFontSize	



#### 24.10.4 All Skin Parameters on the Ashley's PlantUML Doc

You can also view each skinparam parameters with its results displayed at the page [All Skin Parameters of Ashley's PlantUML Doc](#):

- <https://plantuml-documentation.readthedocs.io/en/latest/formatting/all-skin-params.html>.





## 25 Preprocessing

Some preprocessing capabilities are included in **PlantUML**, and available for *all* diagrams.

Those functionalities are very similar to the C language preprocessor, except that the special character `#` has been changed to the exclamation mark `!`.

### 25.1 Variable definition [=, ?=]

Although this is not mandatory, we highly suggest that variable names start with a `$`.

There are three types of data:

- **Integer number** (*int*);
- **String** (*str*) - these must be surrounded by single quote or double quote;
- **JSON** (JSON) - these must be surrounded by curly brackets.

(for JSON variable definition and usage, see more details on *Preprocessing-JSON page*)

Variables created outside function are **global**, that is you can access them from everywhere (including from functions). You can emphasize this by using the optional `global` keyword when defining a variable.

```
@startuml
!$a = 42
!$ab = "foo1"
!$cd = "foo2"
!$ef = $ab + $cd
!$foo = { "name": "John", "age" : 30 }

Alice -> Bob : $a
Alice -> Bob : $ab
Alice -> Bob : $cd
Alice -> Bob : $ef
Alice -> Bob : Do you know **$foo.name** ?
@enduml
```

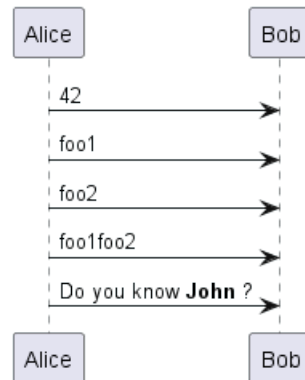

You can also assign a value to a variable, only if it is not already defined, with the syntax: `!$a = "foo"</code`

```
@startuml
Alice -> Bob : 1. **$name** should be empty

!$name = "Charlie"
Alice -&gt; Bob : 2. **$name** should be Charlie

!$name = "David"
Alice -&gt; Bob : 3. **$name** should be David

!$name <?= "Ethan"
Alice -&gt; Bob : 4. **$name** should be David</pre

```



```
@enduml
```

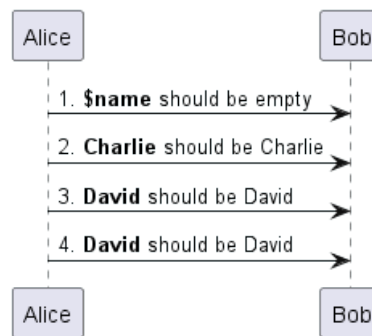

## 25.2 Boolean expression

### 25.2.1 Boolean representation [0 is false]

There is not real boolean type, but PlantUML use this integer convention:

- Integer 0 means **false**
- and any non-null number (as 1) or any string (as "1", or even "0") means **true**.

[Ref. QA-9702]

### 25.2.2 Boolean operation and operator [&&, ||, ()]

You can use boolean expression, in the test, with :

- *parenthesis* ();
- *and operator* &&;
- *or operator* ||.

(See next example, within *if* test.)

### 25.2.3 Boolean builtin functions [%false(), %true(), %not(<exp>)]

For convenience, you can use those boolean builtin functions:

- %false()
- %true()
- %not(<exp>)

[See also *Builtin functions*]

## 25.3 Conditions [!if, !else, !elseif, !endif]

- You can use expression in condition.
- *else* and *elseif* are also implemented

```
@startuml
!$a = 10
!$ijk = "foo"
Alice -> Bob : A
!if ($ijk == "foo") && ($a+10>=4)
Alice -> Bob : yes
!else
Alice -> Bob : This should not appear
!endif
Alice -> Bob : B
@enduml
```



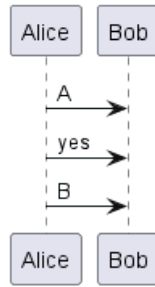

## 25.4 While loop [!while, !endwhile]

You can use `!while` and `!endwhile` keywords to have repeat loops.

### 25.4.1 While loop (on Activity diagram)

```

@startuml
!procedure $foo($arg)
  :procedure start;
  !while $arg!=0
    !$i=3
    #palegreen:arg=$arg;
    !while $i!=0
      :arg=$arg and i=$i;
      !$i = $i - 1
    !endwhile
    !$arg = $arg - 1
  !endwhile
  :procedure end;
!endprocedure

start
$foo(2)
end
@enduml

```

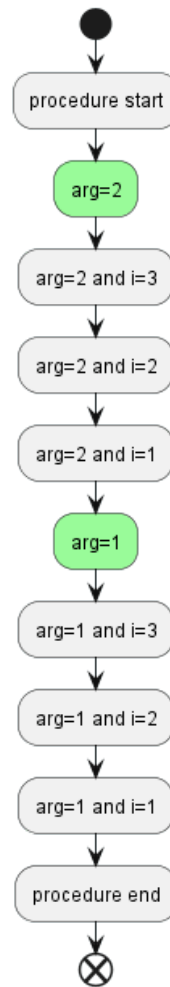

[Adapted from QA-10838]

### 25.4.2 While loop (on Mindmap diagram)

```

@startmindmap
!procedure $foo($arg)
  !while $arg!=0
    !$i=3
    **[#palegreen] arg = $arg
    !while $i!=0
      *** i = $i
      !$i = $i - 1
    !endwhile
    !$arg = $arg - 1
  !endwhile
!endprocedure

*:While
Loop;
$foo(2)
@endmindmap
  
```



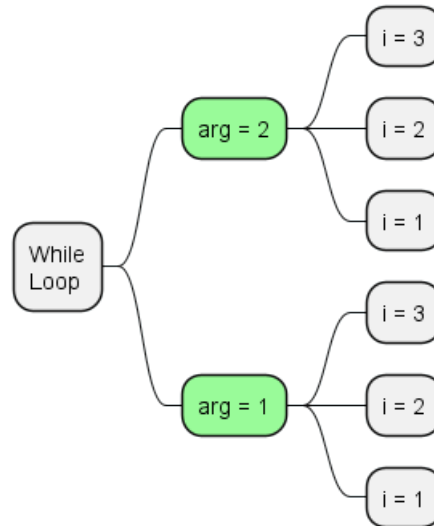

### 25.4.3 While loop (on Component/Deployment diagram)

```

@startuml
!procedure $foo($arg)
  !while $arg!=0
    [Component $arg] as $arg
    !$arg = $arg - 1
  !endwhile
!endprocedure

$foo(4)

1->2
3-->4
@enduml
  
```

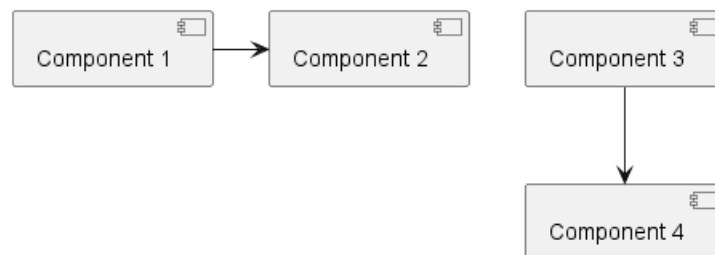

[Ref. QA-14088]

## 25.5 Procedure [!procedure, !endprocedure]

- Procedure names *should* start with a \$
- Argument names *should* start with a \$
- Procedures can call other procedures

Example:

```

@startuml
!procedure $msg($source, $destination)
  $source --> $destination
!endprocedure
  
```



```
!procedure $init_class($name)
  class $name {
    $addCommonMethod()
  }
!endprocedure
```

```
!procedure $addCommonMethod()
  toString()
  hashCode()
!endprocedure
```

```
$init_class("foo1")
$init_class("foo2")
$msg("foo1", "foo2")
@enduml
```

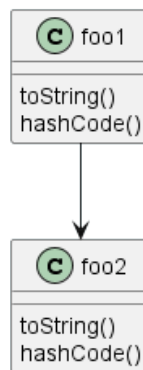

Variables defined in procedures are **local**. It means that the variable is destroyed when the procedure ends.

## 25.6 Return function [!function, !endfunction]

A return function does not output any text. It just define a function that you can call:

- directly in variable definition or in diagram text
- from other return functions
- from procedures
- Function name *should* start with a \$
- Argument names *should* start with a \$

```
@startuml
!function $double($a)
!return $a + $a
!endfunction
```

```
Alice -> Bob : The double of 3 is $double(3)
@enduml
```

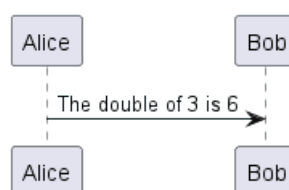

It is possible to shorten simple function definition in one line:

```
@startuml
!function $double($a) !return $a + $a

Alice -> Bob : The double of 3 is $double(3)
Alice -> Bob : $double("This work also for strings.")
@enduml
```

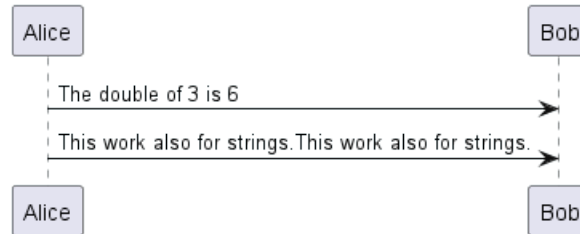

As in procedure (void function), variables are local by default (they are destroyed when the function is exited). However, you can access global variables from a function. However, you can use the `local` keyword to create a local variable if ever a global variable exists with the same name.

```
@startuml
!function $dummy()
!local $ijk = "local"
!return "Alice -> Bob : " + $ijk
!endfunction

!global $ijk = "foo"

Alice -> Bob : $ijk
$dummy()
Alice -> Bob : $ijk
@enduml
```

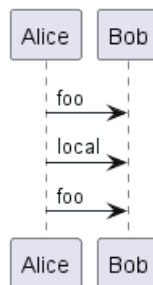

## 25.7 Default argument value

In both procedure and return functions, you can define default values for arguments.

```
@startuml
!function $inc($value, $step=1)
!return $value + $step
!endfunction

Alice -> Bob : Just one more $inc(3)
Alice -> Bob : Add two to three : $inc(3, 2)
@enduml
```



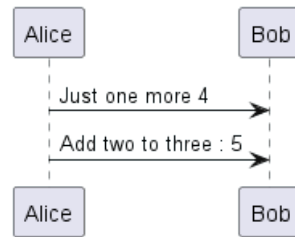

Only arguments at the end of the parameter list can have default values.

```

@startuml
!procedure defaultttest($x, $y="DefaultY", $z="DefaultZ")
note over Alice
  x = $x
  y = $y
  z = $z
end note
!endprocedure

defaultttest(1, 2, 3)
defaultttest(1, 2)
defaultttest(1)
@enduml
  
```

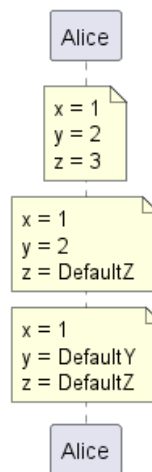

## 25.8 Unquoted procedure or function [!unquoted]

By default, you have to put quotes when you call a function or a procedure. It is possible to use the `unquoted` keyword to indicate that a function or a procedure does not require quotes for its arguments.

```

@startuml
!unquoted function id($text1, $text2="FOO") !return $text1 + $text2

alice -> bob : id(aa)
alice -> bob : id(ab,cd)
@enduml
  
```

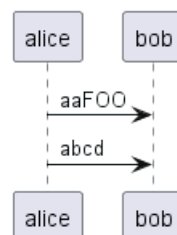



## 25.9 Keywords arguments

Like in Python, you can use keywords arguments :

```
@startuml
```

```
!unquoted procedure $element($alias, $description="", $label="", $technology="", $size=12, $colour="")
rectangle $alias as "
<color:$colour><<$alias>></color>
==$label==
//<size:$size>[$technology]</size>//
```

```
    $description"
!endprocedure
```

```
$element(myalias, "This description is %newline()on several lines", $size=10, $technology="Java")
@enduml
```

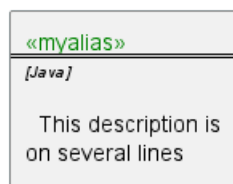

### 25.10 Including files or URL [!include, !include\_many, !include\_once]

Use the `!include` directive to include file in your diagram. Using URL, you can also include file from Internet/Intranet. Protected Internet resources can also be accessed, this is described in URL authentication.

Imagine you have the very same class that appears in many diagrams. Instead of duplicating the description of this class, you can define a file that contains the description.

```
@startuml
```

```
interface List
List : int size()
List : void clear()
List <|.. ArrayList
@enduml
```

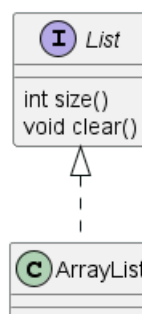

#### File List.iuml

```
interface List
List : int size()
List : void clear()
```

The file `List.iuml` can be included in many diagrams, and any modification in this file will change all diagrams that include it.



You can also put several `@startuml/@enduml` text block in an included file and then specify which block you want to include adding `!0` where 0 is the block number. The `!0` notation denotes the first diagram.

For example, if you use `!include foo.txt!1`, the second `@startuml/@enduml` block within `foo.txt` will be included.

You can also put an id to some `@startuml/@enduml` text block in an included file using `@startuml(id=MY_OWN_ID)` syntax and then include the block adding `!MY_OWN_ID` when including the file, so using something like `!include foo.txt!MY_OWN_ID`.

By default, a file can only be included once. You can use `!include_many` instead of `!include` if you want to include some file several times. Note that there is also a `!include_once` directive that raises an error if a file is included several times.

## 25.11 Including Subpart [`!startsub`, `!endsub`, `!includesub`]

You can also use `!startsub NAME` and `!endsub` to indicate sections of text to include from other files using `!includesub`. For example:

### file1.puml:

```
@startuml

A -> A : stuff1
!startsub BASIC
B -> B : stuff2
!endsub
C -> C : stuff3
!startsub BASIC
D -> D : stuff4
!endsub
@enduml
```

file1.puml would be rendered exactly as if it were:

```
@startuml

A -> A : stuff1
B -> B : stuff2
C -> C : stuff3
D -> D : stuff4
@enduml
```

However, this would also allow you to have another file2.puml like this:

### file2.puml

```
@startuml

title this contains only B and D
!includesub file1.puml!BASIC
@enduml
```

This file would be rendered exactly as if:

```
@startuml

title this contains only B and D
B -> B : stuff2
D -> D : stuff4
@enduml
```

## 25.12 Builtin functions [%]

Some functions are defined by default. Their name starts by %



Name	Description
%chr	Return a character from a give Unicode value
%darken	Return a darken color of a given color with some ratio
%date	Retrieve current date. You can provide an optional format for the date You can provide another optional time (on epoch format)
%dec2hex	Return the hexadecimal string (String) of a decimal value (Int)
%dirpath	Retrieve current dirpath
%feature	Check if some feature is available in the current PlantUML running version
%false	Return always <b>false</b>
%file_exists	Check if a file exists on the local filesystem
%filename	Retrieve current filename
%function_exists	Check if a function exists
%get_variable_value	Retrieve some variable value
%getenv	Retrieve environment variable value
%hex2dec	Return the decimal value (Int) of a hexadecimal string (String)
%hsl_color	Return the RGBA color from a HSL color %hsl_color(h, s, l) or %hsl_color(h, s, l, a)
%intval	Convert a String to Int
%is_dark	Check if a color is a dark one
%is_light	Check if a color is a light one
%lighten	Return a lighten color of a given color with some ratio
%load_json	Load JSON data from local file or external URL
%lower	Return a lowercase string
%newline	Return a newline
%not	Return the logical negation of an expression
%now	Return the current epoch time
%ord	Return a Unicode value from a given character
%lighten	Return a lighten color of a given color with some ratio
%reverse_color	Reverse a color using RGB
%reverse_hsluv_color	Reverse a color using HSLuv
%set_variable_value	Set a global variable
%size	Return the size of any string or JSON structure
%string	Convert an expression to String
%strlen	Calculate the length of a String
%strpos	Search a substring in a string
%substr	Extract a substring. Takes 2 or 3 arguments
%true	Return always <b>true</b>
%upper	Return an uppercase string
%variable_exists	Check if a variable exists
%version	Return PlantUML current version

## 25.13 Logging [!log]

You can use `!log` to add some log output when generating the diagram. This has no impact at all on the diagram itself. However, those logs are printed in the command line's output stream. This could be useful for debug purpose.

```
@startuml
!function bold($text)
!$result = "<b>"+ $text + "</b>"
!log Calling bold function with $text. The result is $result
!return $result
!endfunction

Alice -> Bob : This is bold("bold")
Alice -> Bob : This is bold("a second call")
@enduml
```



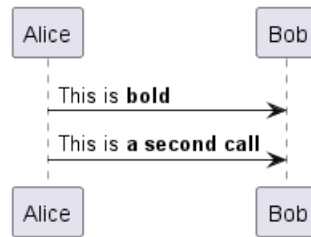

## 25.14 Memory dump [!dump\_memory]

You can use `!dump_memory` to dump the full content of the memory when generating the diagram. An optional string can be put after `!dump_memory`. This has no impact at all on the diagram itself. This could be useful for debug purpose.

```

@startuml
!function $inc($string)
!$val = %intval($string)
!log value is $val
!dump_memory
!return $val+1
!endfunction

Alice -> Bob : 4 $inc("3")
!unused = "foo"
!dump_memory EOF
@enduml
  
```

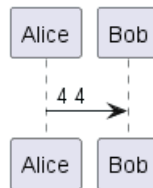

## 25.15 Assertion [!assert]

You can put assertions in your diagram.

```

@startuml
Alice -> Bob : Hello
!assert %strpos("abcdef", "cd")==3 : "This always fails"
@enduml
  
```

**Welcome to PlantUML!**

You can start with a simple UML Diagram like:

```
Bob->Alice: Hello
```

Or

```
class Example
```

You will find more information about PlantUML syntax on <https://plantuml.com>

(Details by typing `license` keyword)



```
PlantUML 1.2023.11
[From string (line 3) ]
@startuml
Alice -> Bob : Hello
!assert %strpos("abcdef", "cd")==3 : "This always fails"
Assertion error : This always fails
```

## 25.16 Building custom library [!import, !include]

It's possible to package a set of included files into a single .zip or .jar archive. This single zip/jar can then be imported into your diagram using `!import` directive.

Once the library has been imported, you can `!include` file from this single zip/jar.

### Example:

```
@startuml

!import /path/to/customLibrary.zip
' This just adds "customLibrary.zip" in the search path

!include myFolder/myFile.iuml
' Assuming that myFolder/myFile.iuml is located somewhere
' either inside "customLibrary.zip" or on the local filesystem

...
```

## 25.17 Search path

You can specify the java property `plantuml.include.path` in the command line.

For example:

```
java -Dplantuml.include.path="c:/mydir" -jar plantuml.jar atest1.txt
```

Note the this `-D` option has to put before the `-jar` option. `-D` options after the `-jar` option will be used to define constants within plantuml preprocessor.

## 25.18 Argument concatenation [##]

It is possible to append text to a macro argument using the `##` syntax.

```
@startuml
!unquoted procedure COMP_TEXTGENCOMP(name)
[name] << Comp >>
interface Ifc << IfcType >> AS name##Ifc
name##Ifc - [name]
!endprocedure
COMP_TEXTGENCOMP(dummy)
@enduml
```



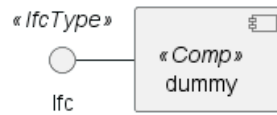

## 25.19 Dynamic invocation [%invoke\_procedure(), %call\_user\_func()]

You can dynamically invoke a procedure using the special `%invoke_procedure()` procedure. This procedure takes as first argument the name of the actual procedure to be called. The optional following arguments are copied to the called procedure.

For example, you can have:

```

@startuml
!procedure $go()
  Bob -> Alice : hello
!endprocedure

!$wrapper = "$go"

%invoke_procedure($wrapper)
@enduml
  
```

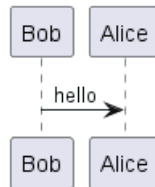

```

@startuml
!procedure $go($txt)
  Bob -> Alice : $txt
!endprocedure

%invoke_procedure("$go", "hello from Bob...")
@enduml
  
```

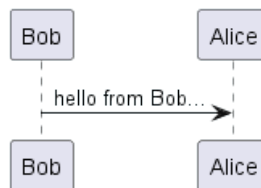

For return functions, you can use the corresponding special function `%call_user_func()` :

```

@startuml
!function bold($text)
!return "<b>"+ $text + "</b>"
!endfunction
  
```

```

Alice -> Bob : %call_user_func("bold", "Hello") there
@enduml
  
```

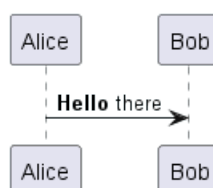

## 25.20 Evaluation of addition depending of data types [+]

Evaluation of  $\$a + \$b$  depending of type of  $\$a$  or  $\$b$

```
@startuml
title
<#LightBlue>|= |= $a |= $b |= <U+0025>string($a + $b)|
<#LightGray>| type | str | str | str (concatenation) |
| example |= "a" |= "b" |= %string("a" + "b") |
<#LightGray>| type | str | int | str (concatenation) |
| ex. |= "a" |= 2 |= %string("a" + 2) |
<#LightGray>| type | str | int | str (concatenation) |
| ex. |= 1 |= "b" |= %string(1 + "b") |
<#LightGray>| type | bool | str | str (concatenation) |
| ex. |= <U+0025>true() |= "b" |= %string(%true() + "b") |
<#LightGray>| type | str | bool | str (concatenation) |
| ex. |= "a" |= <U+0025>false() |= %string("a" + %false()) |
<#LightGray>| type | int | int | int (addition of int) |
| ex. |= 1 |= 2 |= %string(1 + 2) |
<#LightGray>| type | bool | int | int (addition) |
| ex. |= <U+0025>true() |= 2 |= %string(%true() + 2) |
<#LightGray>| type | int | bool | int (addition) |
| ex. |= 1 |= <U+0025>false() |= %string(1 + %false()) |
<#LightGray>| type | int | int | int (addition) |
| ex. |= 1 |= <U+0025>intval("2") |= %string(1 + %intval("2")) |
end title
@enduml
```

	$\$a$	$\$b$	$\%string(\$a + \$b)$
<b>type</b>	<b>str</b>	<b>str</b>	<b>str (concatenation)</b>
<b>example</b>	"a"	"b"	ab
<b>type</b>	<b>str</b>	<b>int</b>	<b>str (concatenation)</b>
<b>ex.</b>	"a"	2	a2
<b>type</b>	<b>str</b>	<b>int</b>	<b>str (concatenation)</b>
<b>ex.</b>	1	"b"	1b
<b>type</b>	<b>bool</b>	<b>str</b>	<b>str (concatenation)</b>
<b>ex.</b>	%true()	"b"	1b
<b>type</b>	<b>str</b>	<b>bool</b>	<b>str (concatenation)</b>
<b>ex.</b>	"a"	%false()	a0
<b>type</b>	<b>int</b>	<b>int</b>	<b>int (addition of int)</b>
<b>ex.</b>	1	2	3
<b>type</b>	<b>bool</b>	<b>int</b>	<b>int (addition)</b>
<b>ex.</b>	%true()	2	3
<b>type</b>	<b>int</b>	<b>bool</b>	<b>int (addition)</b>
<b>ex.</b>	1	%false()	1
<b>type</b>	<b>int</b>	<b>int</b>	<b>int (addition)</b>
<b>ex.</b>	1	%intval("2")	3

## 25.21 Preprocessing JSON

You can extend the functionality of the current Preprocessing with JSON Preprocessing features:

- JSON Variable definition
- Access to JSON data
- Loop over JSON array

(See more details on *Preprocessing-JSON page*)

## 25.22 Including theme [!theme]

Use the `!theme` directive to change the default theme of your diagram.



```
@startuml
!theme spacelab
class Example {
  Theme spacelab
}
@enduml
```

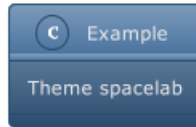

You will find more information on the dedicated page.

## 25.23 Migration notes

The current preprocessor is an update from some legacy preprocessor.

Even if some legacy features are still supported with the actual preprocessor, you should not use them any more (they might be removed in some long term future).

- You should not use `!define` and `!definelong` anymore. Use `!function`, `!procedure` or variable definition instead.
  - `!define` should be replaced by `return !function`
  - `!definelong` should be replaced by `!procedure`.
- `!include` now allows multiple inclusions : you don't have to use `!include_many` anymore
- `!include` now accepts a URL, so you don't need `!includeurl`
- Some features (like `%date%`) have been replaced by builtin functions (for example `%date()`)
- When calling a legacy `!definelong` macro with no arguments, you do have to use parenthesis. You have to use `my_own_definelong()` because `my_own_definelong` without parenthesis is not recognized by the new preprocessor.

Please contact us if you have any issues.

## 25.24 %Splitstr builtin function

```
@startmindmap
!$list = %splitstr("abc~def~ghi", "~")

* root
!foreach $item in $list
  ** $item
!endfor
@endmindmap
```

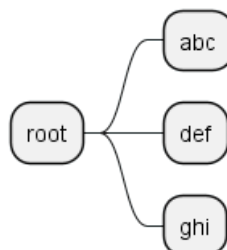

[Ref. QA-15374]





## 26 Unicode

The PlantUML language use *letters* to define actor, usecase and so on.

But *letters* are not only A-Z latin characters, it could be *any kind of letter from any language*.

### 26.1 Examples

```
@startuml
skinparam handwritten true
skinparam backgroundColor #EEEEBC

actor 使用者
participant "頭等艙" as A
participant "第二類" as B
participant "最後一堂課" as 別的東西

使用者 -> A: 完成這項工作
activate A

A -> B: 創建請求
activate B

B -> 別的東西: 創建請求
activate 別的東西
別的東西 --> B: 這項工作完成
destroy 別的東西

B --> A: 請求創建
deactivate B

A --> 使用者: 做完
deactivate A
@enduml
```

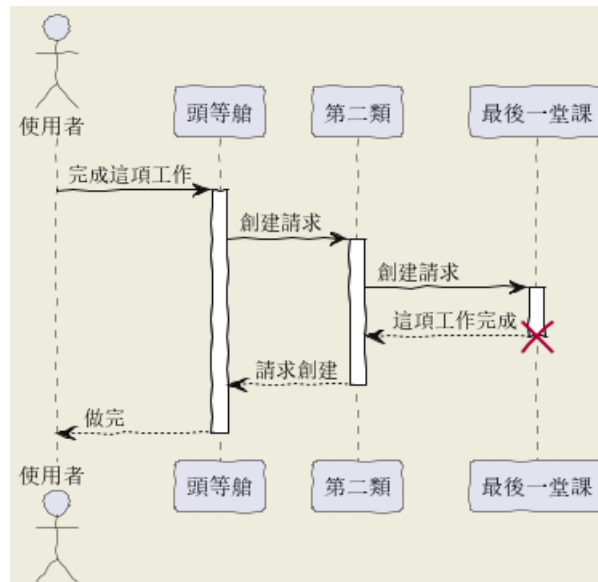

```
@startuml

(*) --> "膩平台"
--> === S1 ===
--> 鞠躬向公眾
--> === S2 ===
```



--> 這傢伙波武器  
 --> (\*)

```
skinparam backgroundColor #AFFFFF
skinparam activityStartColor red
skinparam activityBarColor SaddleBrown
skinparam activityEndColor Silver
skinparam activityBackgroundColor Peru
skinparam activityBorderColor Peru
@enduml
```

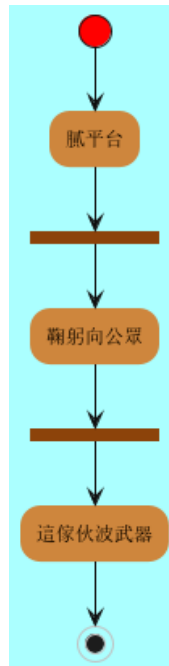

```
@startuml
```

```
skinparam usecaseBackgroundColor DarkSeaGreen
skinparam usecaseArrowColor Olive
skinparam actorBorderColor black
skinparam usecaseBorderColor DarkSlateGray
```

```
使用者 << 人類 >>
"主數據庫" as 數據庫 << 應用程式 >>
(草創) << 一桿 >>
"主数据燕" as (贏余) << 基本的 >>
```

```
使用者 -> (草創)
使用者 --> (贏余)
```

```
數據庫 --> (贏余)
@enduml
```



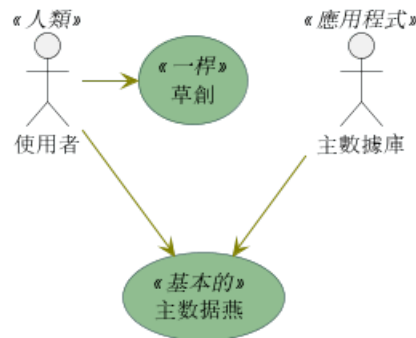

```

@startuml
() "Σ" as Σ
Σ - [Π ]
[Π ] ..> () A : A
@enduml

```

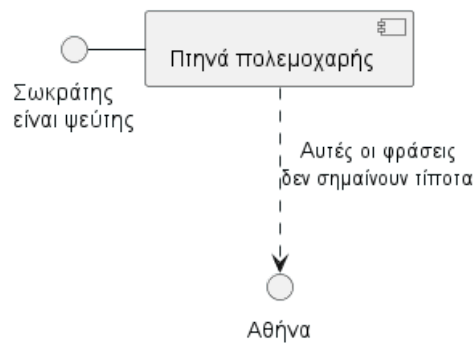

## 26.2 Charset

The default charset used when *reading* the text files containing the UML text description is system dependent.

Normally, it should just be fine, but in some case, you may want to the use another charset. For example, with the command line:

```
java -jar plantuml.jar -charset UTF-8 files.txt
```

Or, with the ant task:

```

<!-- Put images in c:/images directory -->
<target name="main">
<plantuml dir="./src" charset="UTF-8" />

```

Depending of your Java installation, the following charset should be available: ISO-8859-1, UTF-8, UTF-16BE, UTF-16LE, UTF-16.

## 26.3 Using Unicode Character on PlantUML

On PlantUML diagram, you can integrate:

- Special characters using `&#XXXX;` or `<U+XXXX>` form;
- Emoji using `<:XXXXX:>` or `<:NameOfEmoji:>`form.



## 27 PlantUML Standard Library

Welcome to the guide on PlantUML's official **Standard Library** (`stdlib`). Here, we delve into this integral resource that is now included in all official releases of PlantUML, facilitating a richer diagram creation experience. The library borrows its file inclusion convention from the "C standard library", a well-established protocol in the programming world.

### 27.0.1 Standard Library Overview

The Standard Library is a repository of files and resources, constantly updated to enhance your PlantUML experience. It forms the backbone of PlantUML, offering a range of functionalities and features to explore.

### 27.0.2 Contribution from the Community

A significant portion of the library's contents are generously provided by third-party contributors. We extend our heartfelt gratitude to them for their invaluable contributions that have played a pivotal role in enriching the library.

We encourage users to delve into the abundant resources the Standard Library offers, to not only enhance their diagram crafting experience but also possibly contribute and be a part of this collaborative endeavor.

## 27.1 List of Standard Library

You can list standard library folders using the special diagram:

```
@startuml
stdlib
@enduml
```

**archimate**

Version 1.1.0

Delivered by <https://github.com/plantuml-stdlib/Archimate-PlantUML>**aws**

Version 18.02.22

Delivered by <https://github.com/milo-minderbinder/AWS-PlantUML>**awslib**

Version 14.0.0

Delivered by <https://github.com/awslabs/aws-icons-for-plantuml>**azure**

Version 2.2.0

Delivered by <https://github.com/plantuml-stdlib/Azure-PlantUML>**c4**

Version 2.8.0

Delivered by <https://github.com/plantuml-stdlib/C4-PlantUML>**classy**

Version 1.0.0

Delivered by <https://github.com/james-gadrow-kr/classy-plantuml>**classy-c4**

Version 1.0.0

Delivered by <https://github.com/james-gadrow-kr/classy-c4>**cloudinsight**

Version 1.0.0

Delivered by <https://github.com/plantuml-stdlib/cicon-plantuml-sprites>**cloudogu**

Version 1.0.2

Delivered by <https://github.com/cloudogu/plantuml-cloudogu-sprites>**domainstory**

Version 0.3

Delivered by <https://github.com/johthor/DomainStory-PlantUML>**elastic**

Version 0.0.1

Delivered by <https://github.com/Crashedmind/PlantUML-Elastic-icons>**kubernetes**

Version 5.3.45

Delivered by <https://github.com/plantuml-stdlib/plantuml-kubernetes-sprites>**logos**

Version 1.1.0

Delivered by <https://github.com/plantuml-stdlib/gilbarbara-plantuml-sprites>**material**

Version 0.0.1

Delivered by <https://github.com/Templarian/MaterialDesign>**office**

Version 1.0.0

Delivered by <https://github.com/Roemer/plantuml-office>**osa**

Version 0.0.1

Delivered by <https://github.com/Crashedmind/PlantUML-opensecurityarchitecture-icons>**tupadr3**

Version 2.4.0

Delivered by <https://github.com/tupadr3/plantuml-icon-font-sprites>

It is also possible to use the command line `java -jar plantuml.jar -stdlib` to display the same list.

Finally, you can extract the full standard library sources using `java -jar plantuml.jar -extractstdlib`. All files will be extracted in the folder `stdlib`.

Sources used to build official PlantUML releases are hosted here <https://github.com/plantuml/plantuml->



stdlib. You can create Pull Request to update or add some library if you find it relevant.

## 27.2 ArchiMate [archimate]

Type	Link
stdlib	<a href="https://github.com/plantuml/plantuml-stdlib/tree/master/archimate">https://github.com/plantuml/plantuml-stdlib/tree/master/archimate</a>
src	<a href="https://github.com/ebbypeter/ArchiMate-PlantUML">https://github.com/ebbypeter/ArchiMate-PlantUML</a>
orig	<a href="https://en.wikipedia.org/wiki/ArchiMate">https://en.wikipedia.org/wiki/ArchiMate</a>

This repository contains ArchiMate PlantUML macros and other includes for creating Archimate Diagrams easily and consistantly.

```
@startuml
!include <archimate/ArchiMate>

title Archimate Sample - Internet Browser

' Elements
Business_Object(businessObject, "A Business Object")
Business_Process(someBusinessProcess,"Some Business Process")
Business_Service(itSupportService, "IT Support for Business (Application Service)")

Application_DataObject(dataObject, "Web Page Data \n 'on the fly'")
Application_Function(webpageBehaviour, "Web page behaviour")
Application_Component(ActivePartWebPage, "Active Part of the web page \n 'on the fly'")

Technology_Artifact(inMemoryItem,"in memory / 'on the fly' html/javascript")
Technology_Service(internetBrowser, "Internet Browser Generic & Plugin")
Technology_Service(internetBrowserPlugin, "Some Internet Browser Plugin")
Technology_Service(webServer, "Some web server")

'Relationships
Rel_Flow_Left(someBusinessProcess, businessObject, "")
Rel_Serving_Up(itSupportService, someBusinessProcess, "")
Rel_Specialization_Up(webpageBehaviour, itSupportService, "")
Rel_Flow_Right(dataObject, webpageBehaviour, "")
Rel_Specialization_Up(dataObject, businessObject, "")
Rel_Assignment_Left(ActivePartWebPage, webpageBehaviour, "")
Rel_Specialization_Up(inMemoryItem, dataObject, "")
Rel_Realization_Up(inMemoryItem, ActivePartWebPage, "")
Rel_Specialization_Right(inMemoryItem,internetBrowser, "")
Rel_Serving_Up(internetBrowser, webpageBehaviour, "")
Rel_Serving_Up(internetBrowserPlugin, webpageBehaviour, "")
Rel_Aggregation_Right(internetBrowser, internetBrowserPlugin, "")
Rel_Access_Up(webServer, inMemoryItem, "")
Rel_Serving_Up(webServer, internetBrowser, "")
@enduml
```



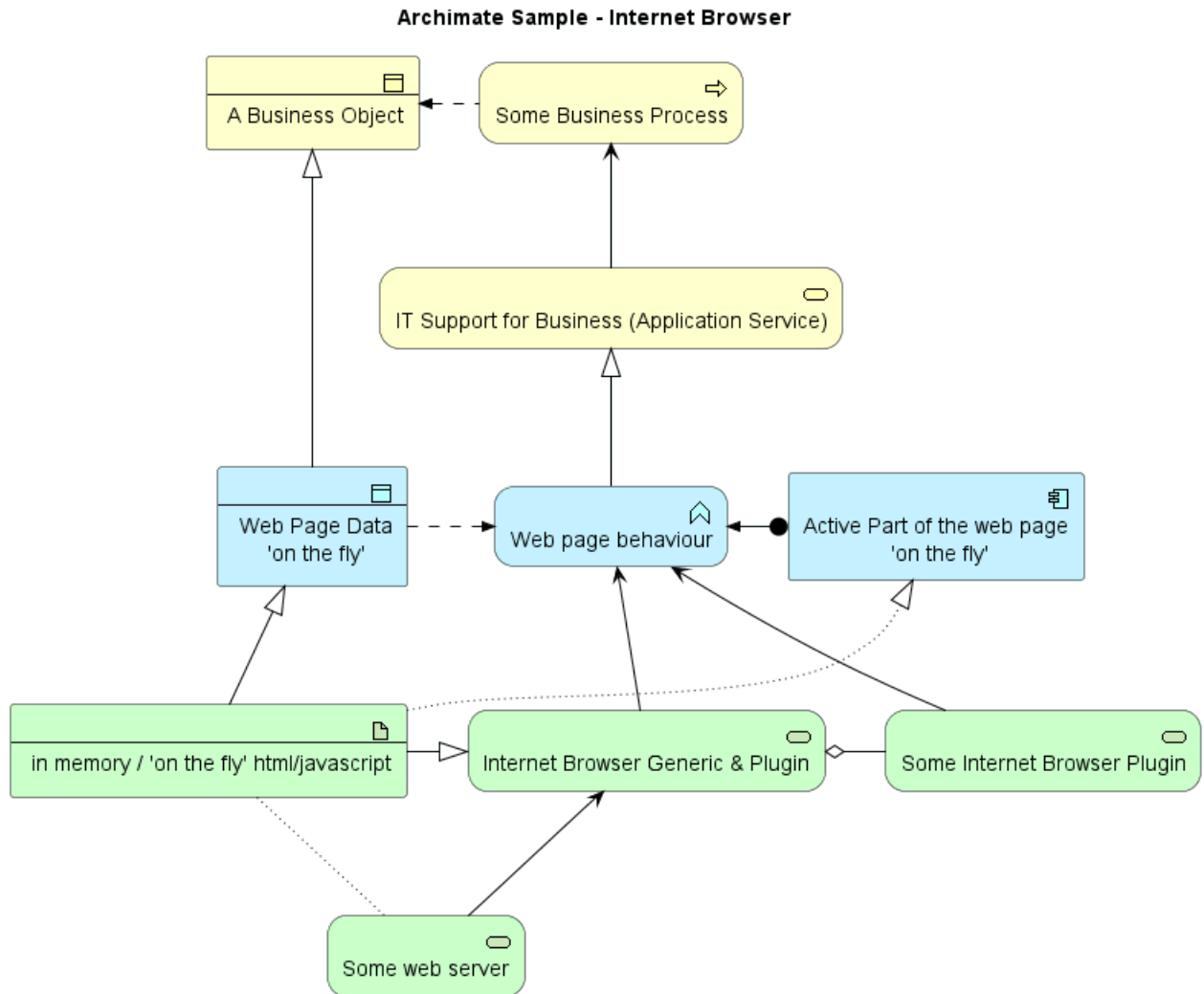

### 27.2.1 List possible sprites

You can list all possible sprites for Archimate using the following diagram:

```

@startuml
listsprite
@enduml
  
```

**List Current Sprites**

Credit to

<http://www.archimatetool.com>

archimate :

access  
 activity  
 actor  
 aggregation  
 application-collaboration  
 application-component  
 application-data-object  
 application-event  
 application-function  
 application-interaction  
 application-interface  
 application-process  
 application-service  
 assessment-filled  
 assessment  
 assignment  
 association-unidirect  
 association  
 business-activity  
 business-actor  
 business-collaboration  
 business-contract  
 business-event  
 business-function  
 business-interaction  
 business-interface  
 business-location  
 business-meaning  
 business-object  
 business-process  
 business-product  
 business-representation  
 business-role  
 business-service  
 business-value  
 collaboration  
 communication-path  
 component  
 composition  
 constraint-filled  
 constraint  
 contract  
 deliverable-filled  
 deliverable  
 device  
 driver-filled  
 driver  
 event  
 flow  
 function  
 gap-filled  
 gap  
 goal-filled  
 goal  
 implementation-deliverable  
 implementation-event  
 implementation-gap  
 implementation-plateau  
 implementation-workpackage  
 influence  
 interaction  
 interface-required

interface-symmetric  
 interface  
 junction-and  
 junction-or  
 junction  
 location  
 meaning  
 motivation-assessment  
 motivation-constraint  
 motivation-driver  
 motivation-goal  
 motivation-meaning  
 motivation-outcome  
 motivation-principle  
 motivation-requirement  
 motivation-stakeholder  
 motivation-value  
 network  
 node  
 object  
 physical-distribution-network  
 physical-equipment  
 physical-facility  
 physical-material  
 plateau  
 principle-filled  
 principle  
 process  
 product  
 realisation  
 representation  
 requirement-filled  
 requirement  
 role

service  
 serving  
 specialisation  
 specialization  
 stakeholder-filled  
 strategy-capability  
 strategy-course-of-action  
 strategy-resource  
 strategy-value-stream  
 system-software  
 technology-artifact  
 technology-collaboration  
 technology-communication-network  
 technology-communication-path  
 technology-device  
 technology-event  
 technology-function  
 technology-infra-interface  
 technology-infra-service  
 technology-interaction  
 technology-interface  
 technology-network  
 technology-node  
 technology-path  
 technology-process  
 technology-service  
 technology-system-software  
 triggering  
 used-by  
 value  
 workpackage-filled

## 27.3 Amazon Labs AWS Library [awslib]

Type	Link
stdlib	<a href="https://github.com/plantuml/plantuml-stdlib/tree/master/awslib">https://github.com/plantuml/plantuml-stdlib/tree/master/awslib</a>
src	<a href="https://github.com/aws-labs/aws-icons-for-plantuml">https://github.com/aws-labs/aws-icons-for-plantuml</a>
orig	<a href="https://aws.amazon.com/en/architecture/icons/">https://aws.amazon.com/en/architecture/icons/</a>

The Amazon Labs AWS library provides PlantUML sprites, macros, and other includes for Amazon Web Services (AWS) services and resources.

Used to create PlantUML diagrams with AWS components. All elements are generated from the official AWS Architecture Icons and when combined with PlantUML and the C4 model, are a great way to communicate your design, deployment, and topology as code.

```

@startuml
!include <awslib/AWSCommon>
!include <awslib/InternetOfThings/IoTRule>
!include <awslib/Analytics/KinesisDataStreams>
!include <awslib/ApplicationIntegration/SimpleQueueService>

```

```
left to right direction
```

```
agent "Published Event" as event #fff
```

```

IoTRule(iotRule, "Action Error Rule", "error if Kinesis fails")
KinesisDataStreams(eventStream, "IoT Events", "2 shards")
SimpleQueueService(errorQueue, "Rule Error Queue", "failed Rule actions")

```

```

event --> iotRule : JSON message
iotRule --> eventStream : messages
iotRule --> errorQueue : Failed action message
@enduml

```





## 27.4 Azure library [azure]

Type	Link
stdlib	<a href="https://github.com/plantuml/plantuml-stdlib/tree/master/azure">https://github.com/plantuml/plantuml-stdlib/tree/master/azure</a>
src	<a href="https://github.com/RicardoNiepel/Azure-PlantUML/">https://github.com/RicardoNiepel/Azure-PlantUML/</a>
orig	Microsoft Azure

The Azure library consists of Microsoft Azure icons.

Use it by including the file that contains the sprite, eg: `!include <azure/Analytics/AzureEventHub>`.  
When imported, you can use the sprite as normally you would, using `<$sprite_name>`.

You may also include the `AzureCommon.puml` file, eg: `!include <azure/AzureCommon>`, which contains helper macros defined. With the `AzureCommon.puml` imported, you can use the `NAME_OF_SPRITE(parameters...)` macro.

Example of usage:

```
@startuml
!include <azure/AzureCommon>
!include <azure/Analytics/AzureEventHub>
!include <azure/Analytics/AzureStreamAnalyticsJob>
!include <azure/Databases/AzureCosmosDb>
```

```
left to right direction
```

```
agent "Device Simulator" as devices #fff
```

```
AzureEventHub(fareDataEventHub, "Fare Data", "PK: Medallion HackLicense VendorId; 3 TUs")
AzureEventHub(tripDataEventHub, "Trip Data", "PK: Medallion HackLicense VendorId; 3 TUs")
AzureStreamAnalyticsJob(streamAnalytics, "Stream Processing", "6 SUs")
AzureCosmosDb(outputCosmosDb, "Output Database", "1,000 RUs")
```

```
devices --> fareDataEventHub
devices --> tripDataEventHub
fareDataEventHub --> streamAnalytics
tripDataEventHub --> streamAnalytics
streamAnalytics --> outputCosmosDb
@enduml
```

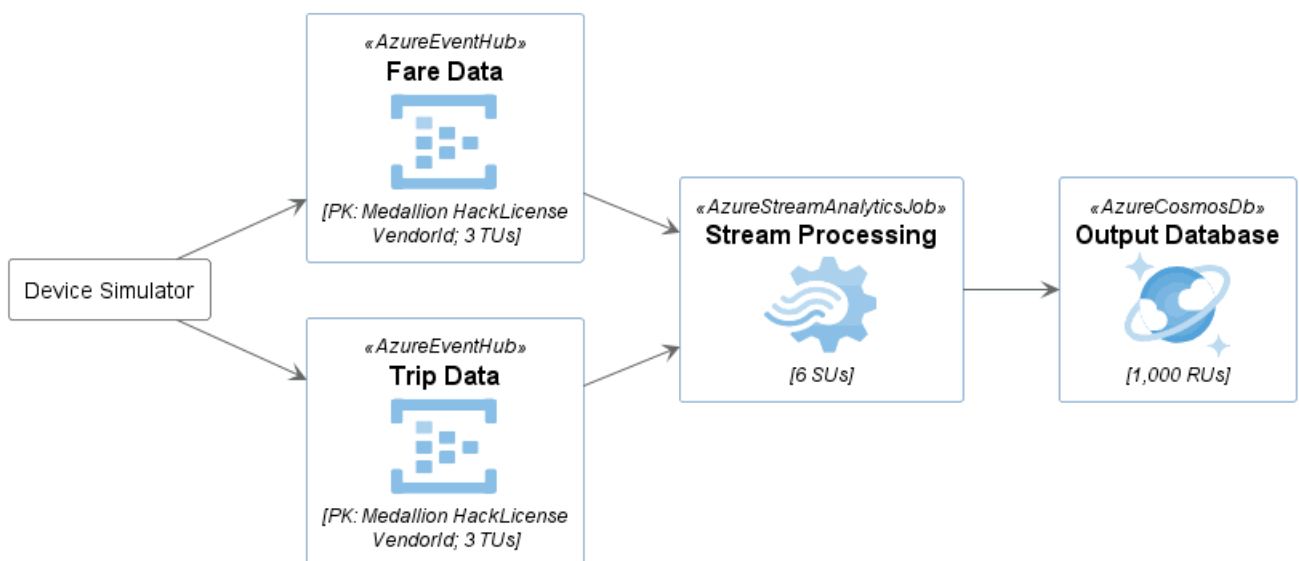

## 27.5 C4 Library [C4]

Type	Link
stdlib	<a href="https://github.com/plantuml/plantuml-stdlib/tree/master/C4">https://github.com/plantuml/plantuml-stdlib/tree/master/C4</a>
src	<a href="https://github.com/plantuml-stdlib/C4-PlantUML">https://github.com/plantuml-stdlib/C4-PlantUML</a>
orig	<a href="https://en.wikipedia.org/wiki/C4_model">https://en.wikipedia.org/wiki/C4_model</a> <a href="https://c4model.com">https://c4model.com</a>

```

@startuml
!include <C4/C4_Container>

Person(personAlias, "Label", "Optional Description")
Container(containerAlias, "Label", "Technology", "Optional Description")
System(systemAlias, "Label", "Optional Description")

System_Ext(extSystemAlias, "Label", "Optional Description")

Rel(personAlias, containerAlias, "Label", "Optional Technology")

Rel_U(systemAlias, extSystemAlias, "Label", "Optional Technology")
@enduml

```

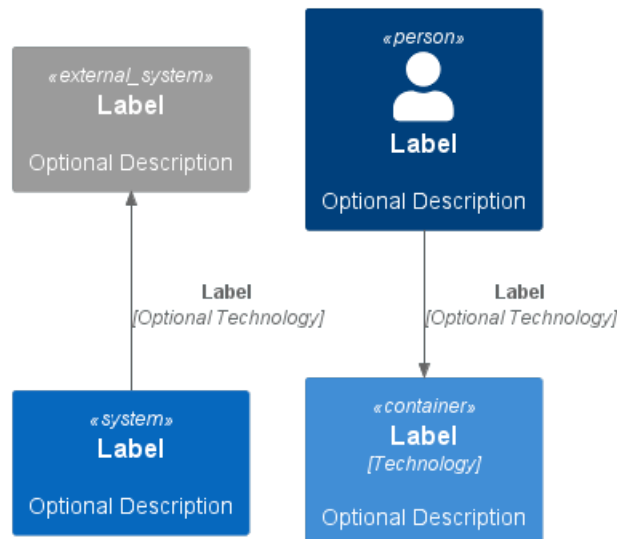

## 27.6 Cloud Insight [cloudinsight]

Type	Link
stdlib	<a href="https://github.com/plantuml/plantuml-stdlib/tree/master/cloudinsight">https://github.com/plantuml/plantuml-stdlib/tree/master/cloudinsight</a>
src	<a href="https://github.com/rabelenda/cicon-plantuml-sprites">https://github.com/rabelenda/cicon-plantuml-sprites</a>
orig	Cloudinsight icons

This repository contains PlantUML sprites generated from Cloudinsight icons, which can easily be used in PlantUML diagrams for nice visual representation of popular technologies.

```

@startuml
!include <cloudinsight/tomcat>
!include <cloudinsight/kafka>
!include <cloudinsight/java>
!include <cloudinsight/cassandra>

title Cloudinsight sprites example

skinparam monochrome true

rectangle "<$tomcat>\nwebapp" as webapp

```



```
queue "<$kafka>" as kafka
rectangle "<$java>\ndaemon" as daemon
database "<$cassandra>" as cassandra
```

```
webapp -> kafka
kafka -> daemon
daemon --> cassandra
@enduml
```

Cloudinsight sprites example

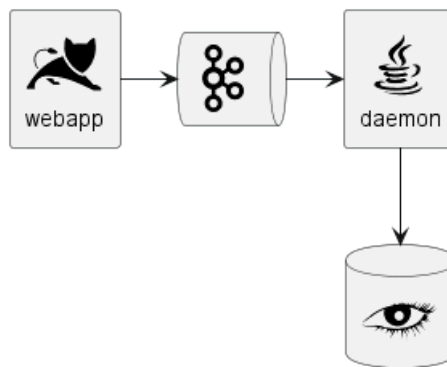

## 27.7 Clodogu [cloudogu]

Type	Link
stdlib	<a href="https://github.com/plantuml/plantuml-stdlib/tree/master/cloudogu">https://github.com/plantuml/plantuml-stdlib/tree/master/cloudogu</a>
src	<a href="https://github.com/cloudogu/plantuml-cloudogu-sprites">https://github.com/cloudogu/plantuml-cloudogu-sprites</a>
orig	<a href="https://cloudogu.com">https://cloudogu.com</a>

The Clodogu library provides PlantUML sprites, macros, and other includes for Clodogu services and resources.

```
@startuml
!include <cloudogu/common>
!include <cloudogu/dogus/jenkins>
!include <cloudogu/dogus/cloudogu>
!include <cloudogu/dogus/scm>
!include <cloudogu/dogus/smeagol>
!include <cloudogu/dogus/nexus>
!include <cloudogu/tools/k8s>

node "Cloudogu Ecosystem" <<$cloudogu>> {
DOGU_JENKINS(jenkins, Jenkins) #ffffff
DOGU_SCM(scm, SCM-Manager) #ffffff
DOGU_SMEAGOL(smeagol, Smeagol) #ffffff
DOGU_NEXUS(nexus, Nexus) #ffffff
}

TOOL_K8S(k8s, Kubernetes) #ffffff

actor developer

developer --> smeagol : "Edit Slides"
smeagol -> scm : Push
scm -> jenkins : Trigger
jenkins -> nexus : Deploy
jenkins --> k8s : Deploy
```



```
@enduml
```

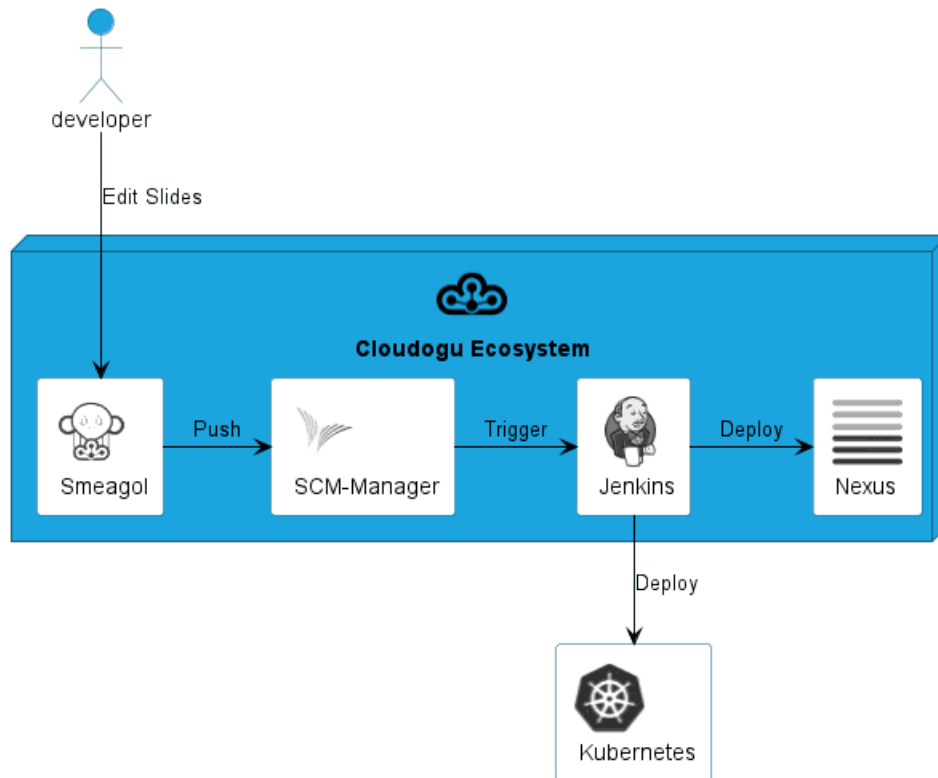

### All cloudogu sprites

See all possible cloudogu sprites on [plantuml-cloudogu-sprites](https://github.com/plantuml-cloudogu-sprites).

## 27.8 Elastic library [elastic]

Type	Link
stdlib	<a href="https://github.com/plantuml/plantuml-stdlib/tree/master/elastic">https://github.com/plantuml/plantuml-stdlib/tree/master/elastic</a>
src	<a href="https://github.com/Crashedmind/PlantUML-Elastic-icons">https://github.com/Crashedmind/PlantUML-Elastic-icons</a>
orig	Elastic

The Elastic library consists of Elastic icons. It is similar in use to the AWS and Azure libraries (it used the same tool to create them).

Use it by including the file that contains the sprite, eg: `!include elastic/elastic_search/elastic_search>`. When imported, you can use the sprite as normally you would, using `<$sprite_name>`.

You may also include the `common.puml` file, eg: `!include <elastic/common>`, which contains helper macros defined. With the `common.puml` imported, you can use the `NAME//OF//SPRITE(parameters...)` macro.

Example of usage:

```

@startuml
!include <elastic/common>
!include <elastic/elasticsearch/elasticsearch>
!include <elastic/logstash/logstash>
!include <elastic/kibana/kibana>

ELASTICSEARCH(ElasticSearch, "Search and Analyze",database)
LOGSTASH(Logstash, "Parse and Transform",node)
KIBANA(Kibana, "Visualize",agent)

```

```
Logstash -right-> ElasticSearch: Transformed Data
```



ElasticSearch -right-> Kibana: Data to View  
 @enduml

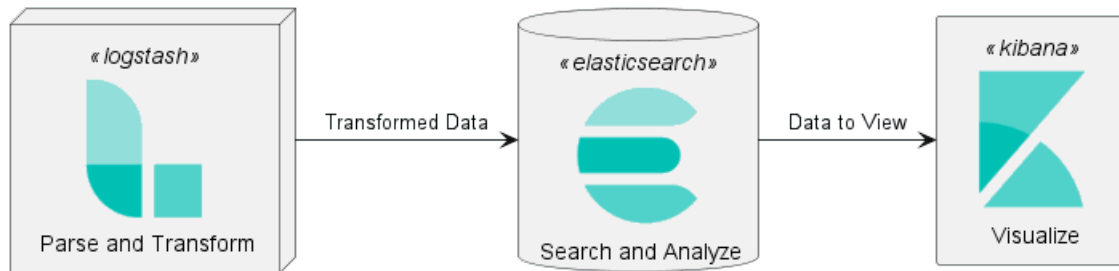

### All Elastic Sprite Set

@startuml

'Adapted from <https://github.com/Crashedmind/PlantUML-Elastic-icons/blob/master/All.puml>

'Elastic stuff here

'=====

```

!include <elastic/common>
!include <elastic/apm/apm>
!include <elastic/app_search/app_search>
!include <elastic/beats/beats>
!include <elastic/cloud/cloud>
!include <elastic/cloud_in_kubernetes/cloud_in_kubernetes>
!include <elastic/code_search/code_search>
!include <elastic/ece/ece>
!include <elastic/eck/eck>
' Beware of the difference between Crashedmind and plantuml-stdlib version: with '_' usage!
!include <elastic/elasticsearch/elasticsearch>
!include <elastic/endpoint/endpoint>
!include <elastic/enterprise_search/enterprise_search>
!include <elastic/kibana/kibana>
!include <elastic/logging/logging>
!include <elastic/logstash/logstash>
!include <elastic/maps/maps>
!include <elastic/metrics/metrics>
!include <elastic/siem/siem>
!include <elastic/site_search/site_search>
!include <elastic/stack/stack>
!include <elastic/uptime/uptime>

```

skinparam agentBackgroundColor White

```

APM(apm)
APP_SEARCH(app_search)
BEATS(beats)
CLOUD(cloud)
CLOUD_IN_KUBERNETES(cloud_in_kubernetes)
CODE_SEARCH(code_search)
ECE(ece)
ECK(eck)
ELASTICSEARCH(elastic_search)
ENDPOINT(endpoint)
ENTERPRISE_SEARCH(enterprise_search)
KIBANA(kibana)
LOGGING(logging)

```



```

LOGSTASH(logstash)
MAPS(maps)
METRICS(metrics)
SIEM(siem)
SITE_SEARCH(site_search)
STACK(stack)
UPTIME(uptime)
@enduml

```

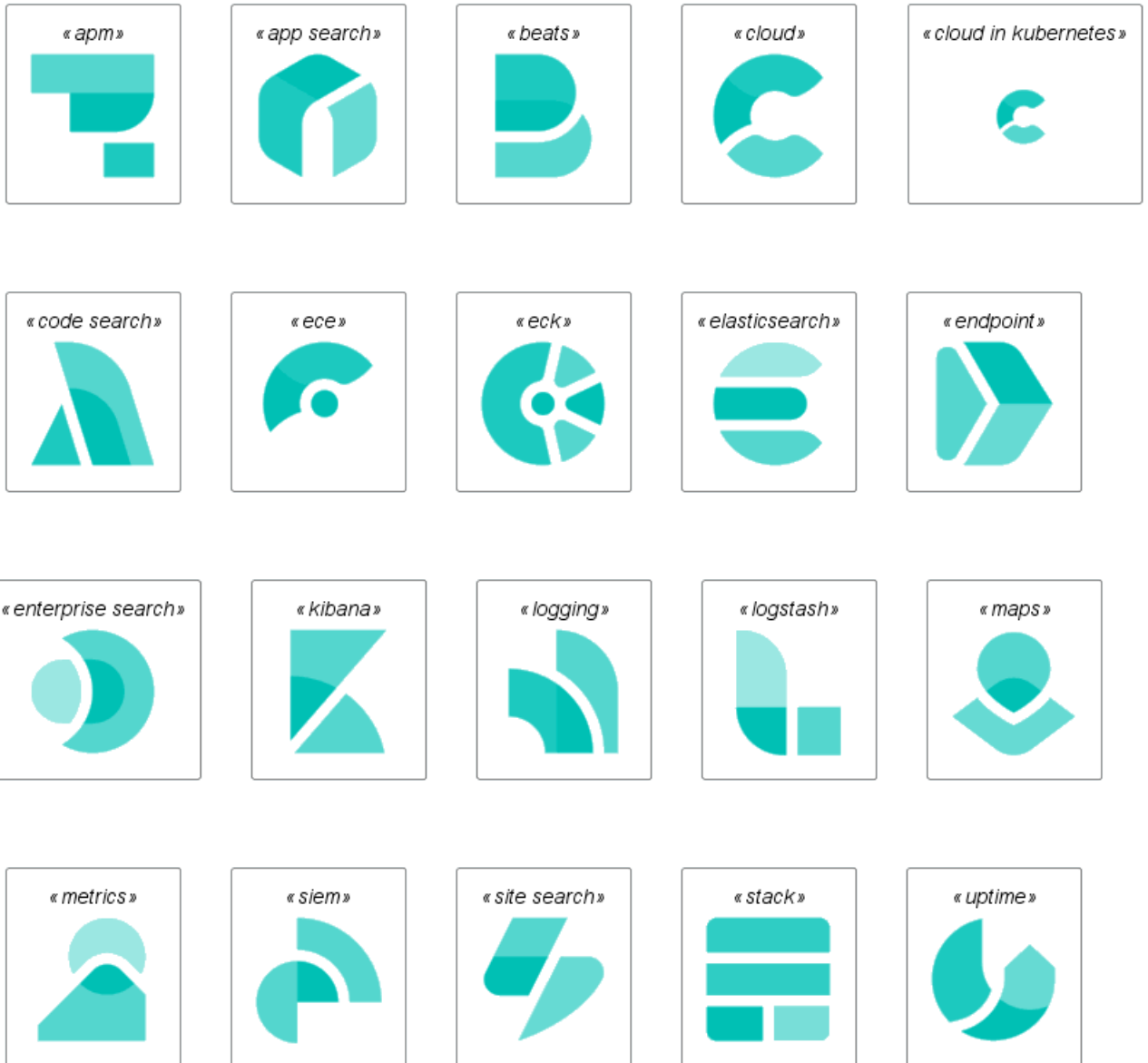

## 27.9 Google Material Icons [material]

Type	Link
stdlib	<a href="https://github.com/plantuml/plantuml-stdlib/tree/master/material">https://github.com/plantuml/plantuml-stdlib/tree/master/material</a>
src	<a href="https://github.com/Templarian/MaterialDesign">https://github.com/Templarian/MaterialDesign</a>
orig	Material Design Icons

This library consists of a free Material style icons from Google and other artists.

Use it by including the file that contains the sprite, eg: `!include <material/ma_folder_move>`. When imported, you can use the sprite as normally you would, using `<$ma_sprite_name>`. Notice that this

library requires an `ma_` prefix on sprites names, this is to avoid clash of names if multiple sprites have the same name on different libraries.

You may also include the `common.puml` file, eg: `!include <material/common>`, which contains helper macros defined. With the `common.puml` imported, you can use the `MA_NAME_OF_SPRITE(parameters...)` macro, note again the use of the prefix `MA_`.

Example of usage:

```
@startuml
!include <material/common>
' To import the sprite file you DON'T need to place a prefix!
!include <material/folder_move>

MA_FOLDER_MOVE(Red, 1, dir, rectangle, "A label")
@enduml
```

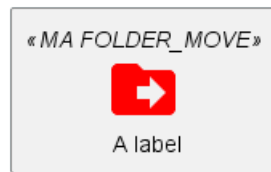

#### Notes:

When mixing sprites macros with other elements you may get a syntax error if, for example, trying to add a rectangle along with classes. In those cases, add `{` and `}` after the macro to create the empty rectangle.

Example of usage:

```
@startuml
!include <material/common>
' To import the sprite file you DON'T need to place a prefix!
!include <material/folder_move>

MA_FOLDER_MOVE(Red, 1, dir, rectangle, "A label") {

class foo {
    bar
}
@enduml
```



## 27.10 Kubernetes [kubernetes]

Type	Link
stdlib	<a href="https://github.com/plantuml/plantuml-stdlib/tree/master/kubernetes">https://github.com/plantuml/plantuml-stdlib/tree/master/kubernetes</a>
src	<a href="https://github.com/michiel/plantuml-kubernetes-sprites">https://github.com/michiel/plantuml-kubernetes-sprites</a>
orig	Kubernetes

```
@startuml
!include <kubernetes/k8s-sprites-unlabeled-25pct>
package "Infrastructure" {
    component "<$master>\nmaster" as master
```



```

component "<$etcd>\netcd" as etcd
component "<$node>\nnode" as node
}
@enduml

```



## 27.11 Logos [logos]

Type	Link
stdlib	<a href="https://github.com/plantuml/plantuml-stdlib/tree/master/logos">https://github.com/plantuml/plantuml-stdlib/tree/master/logos</a>
src	<a href="https://github.com/plantuml-stdlib/gilbarbara-plantuml-sprites">https://github.com/plantuml-stdlib/gilbarbara-plantuml-sprites</a>
orig	Gil Barbara's logos

This repository contains PlantUML sprites generated from Gil Barbara's logos, which can easily be used in PlantUML diagrams for nice visual aid.

```

@startuml
!include <logos/flask>
!include <logos/kafka>
!include <logos/kotlin>
!include <logos/cassandra>

title Gil Barbara's logos example

skinparam monochrome true

rectangle "<$flask>\nwebapp" as webapp
queue "<$kafka>" as kafka
rectangle "<$kotlin>\ndaemon" as daemon
database "<$cassandra>" as cassandra

webapp -> kafka
kafka -> daemon
daemon --> cassandra
@enduml

```



Gil Barbara's logos example

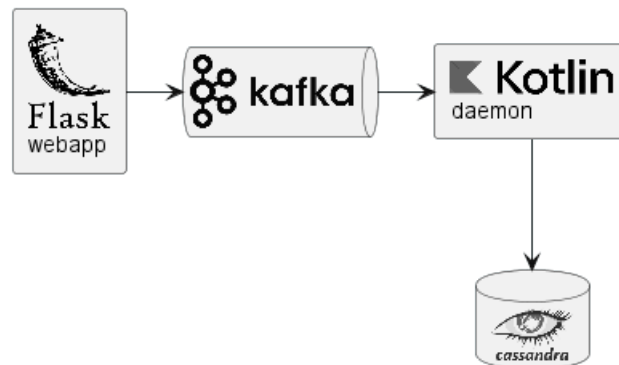

```

@startuml
scale 0.7
!include <logos/apple-pay>
!include <logos/dinersclub>
!include <logos/discover>
!include <logos/google-pay>
!include <logos/jcb>
!include <logos/maestro>
!include <logos/mastercard>
!include <logos/paypal>
!include <logos/unionpay>
!include <logos/visaelectron>
!include <logos/visa>
' ...

title Gil Barbara's logos example - **Payment Scheme**

actor customer
rectangle "<$apple-pay>" as ap
rectangle "<$dinersclub>" as dc
rectangle "<$discover>" as d
rectangle "<$google-pay>" as gp
rectangle "<$jcb>" as j
rectangle "<$maestro>" as ma
rectangle "<$mastercard>" as m
rectangle "<$paypal>" as p
rectangle "<$unionpay>" as up
rectangle "<$visa>" as v
rectangle "<$visaelectron>" as ve
rectangle "... " as etc

customer --> ap
customer ---> dc
customer --> d
customer ---> gp
customer --> j
customer ---> ma
customer --> m
customer ---> p
customer --> up
customer ---> v
customer --> ve
customer ---> etc
  
```

```
@enduml
```

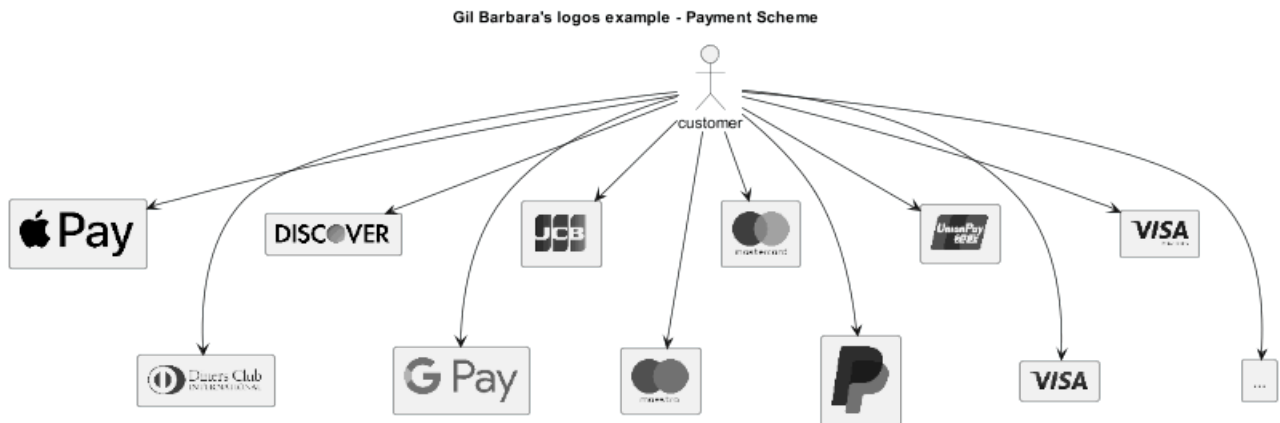

## 27.12 Office [office]

Type	Link
stdlib	<a href="https://github.com/plantuml/plantuml-stdlib/tree/master/office">https://github.com/plantuml/plantuml-stdlib/tree/master/office</a>
src	<a href="https://github.com/Roemer/plantuml-office">https://github.com/Roemer/plantuml-office</a>
orig	

There are sprites (\*.puml) and colored png icons available. Be aware that the sprites are all only monochrome even if they have a color in their name (due to automatically generating the files). You can either color the sprites with the macro (see examples below) or directly use the fully colored pngs. See the following examples on how to use the sprites, the pngs and the macros.

Example of usage:

```
@startuml
!include <tupadr3/common>

!include <office/Servers/database_server>
!include <office/Servers/application_server>
!include <office/Concepts/firewall_orange>
!include <office/Clouds/cloud_disaster_red>

title Office Icons Example

package "Sprites" {
    OFF_DATABASE_SERVER(db,DB)
    OFF_APPLICATION_SERVER(app,App-Server)
    OFF_FIREWALL_ORANGE(fw,Firewall)
    OFF_CLOUD_DISASTER_RED(cloud,Cloud)
    db <-> app
    app <--> fw
    fw <.left.> cloud
}
@enduml
```

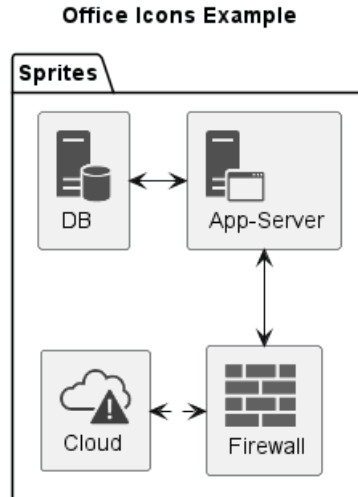

```

@startuml
!include <tupadr3/common>

!include <office/servers/database_server>
!include <office/servers/application_server>
!include <office/Concepts/firewall_orange>
!include <office/Clouds/cloud_disaster_red>

' Used to center the label under the images
skinparam defaultTextAlignment center

title Extended Office Icons Example

package "Use sprite directly" {
  [Some <$cloud_disaster_red> object]
}

package "Different macro usages" {
  OFF_CLOUD_DISASTER_RED(cloud1)
  OFF_CLOUD_DISASTER_RED(cloud2,Default with text)
  OFF_CLOUD_DISASTER_RED(cloud3,Other shape,Folder)
  OFF_CLOUD_DISASTER_RED(cloud4,Even another shape,Database)
  OFF_CLOUD_DISASTER_RED(cloud5,Colored,Rectangle, red)
  OFF_CLOUD_DISASTER_RED(cloud6,Colored background) #red
}
@enduml

```

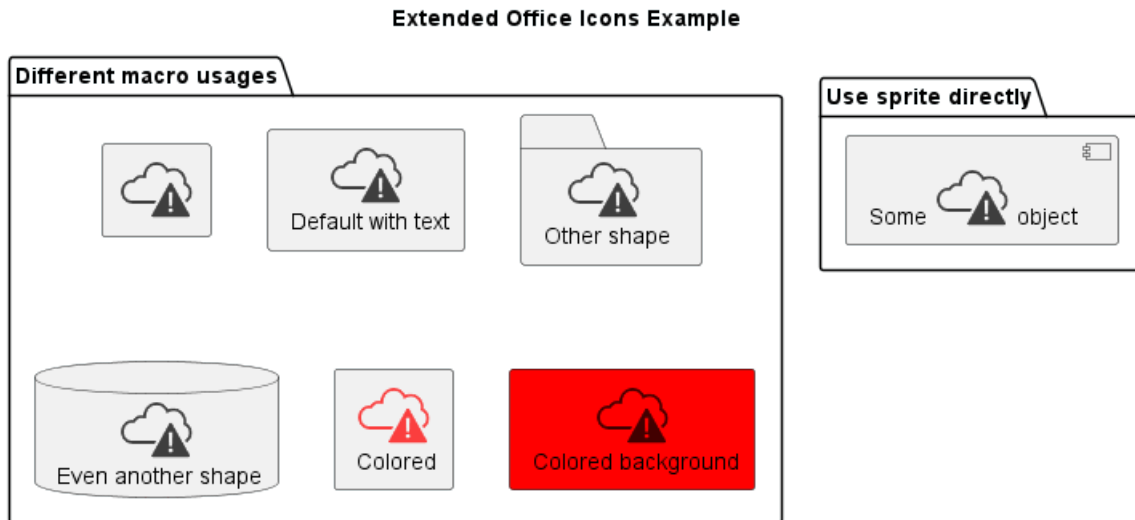

## 27.13 Open Security Architecture (OSA) [osa]

Type	Link
stdlib	<a href="https://github.com/plantuml/plantuml-stdlib/tree/master/osa">https://github.com/plantuml/plantuml-stdlib/tree/master/osa</a>
src	<a href="https://github.com/Crashedmind/PlantUML-opensecurityarchitecture-icons">https://github.com/Crashedmind/PlantUML-opensecurityarchitecture-icons</a>
orig	<a href="https://www.opensecurityarchitecture.org">https://www.opensecurityarchitecture.org</a>

```
@startuml
```

```
'Adapted from https://github.com/Crashedmind/PlantUML-opensecurityarchitecture-icons/blob/master/all
scale .5
```

```
!include <osa/arrow/green/left/left>
!include <osa/arrow/yellow/right/right>
!include <osa/awareness/awareness>
!include <osa/contract/contract>
!include <osa/database/database>
!include <osa/desktop/desktop>
!include <osa/desktop/imac/imac>
!include <osa/device_music/device_music>
!include <osa/device_scanner/device_scanner>
!include <osa/device_usb/device_usb>
!include <osa/device_wireless_router/device_wireless_router>
!include <osa/disposal/disposal>
!include <osa/drive_optical/drive_optical>
!include <osa/firewall/firewall>
!include <osa/hub/hub>
!include <osa/ics/drive/drive>
!include <osa/ics/plc/plc>
!include <osa/ics/thermometer/thermometer>
!include <osa/id/card/card>
!include <osa/laptop/laptop>
!include <osa/lifecycle/lifecycle>
!include <osa/lightning/lightning>
!include <osa/media_flash/media_flash>
!include <osa/media_optical/media_optical>
!include <osa/media_tape/media_tape>
!include <osa/mobile/pda/pda>
!include <osa/padlock/padlock>
!include <osa/printer/printer>
!include <osa/site_branch/site_branch>
!include <osa/site_factory/site_factory>
!include <osa/vpn/vpn>
```



```
!include <osa/wireless/network/network>

rectangle "OSA" {
rectangle "Left:\n <$left>"
rectangle "Right:\n <$right>"
rectangle "Awareness:\n <$awareness>"
rectangle "Contract:\n <$contract>"
rectangle "Database:\n <$database>"
rectangle "Desktop:\n <$desktop>"
rectangle "Imac:\n <$imac>"
rectangle "Device_music:\n <$device_music>"
rectangle "Device_scanner:\n <$device_scanner>"
rectangle "Device_usb:\n <$device_usb>"
rectangle "Device_wireless_router:\n <$device_wireless_router>"
rectangle "Disposal:\n <$disposal>"
rectangle "Drive_optical:\n <$drive_optical>"
rectangle "Firewall:\n <$firewall>"
rectangle "Hub:\n <$hub>"
rectangle "Drive:\n <$drive>"
rectangle "Plc:\n <$plc>"
rectangle "Thermometer:\n <$thermometer>"
rectangle "Card:\n <$card>"
rectangle "Laptop:\n <$laptop>"
rectangle "Lifecycle:\n <$lifecycle>"
rectangle "Lightning:\n <$lightning>"
rectangle "Media_flash:\n <$media_flash>"
rectangle "Media_optical:\n <$media_optical>"
rectangle "Media_tape:\n <$media_tape>"
rectangle "Pda:\n <$pda>"
rectangle "Padlock:\n <$padlock>"
rectangle "Printer:\n <$printer>"
rectangle "Site_branch:\n <$site_branch>"
rectangle "Site_factory:\n <$site_factory>"
rectangle "Vpn:\n <$vpn>"
rectangle "Network:\n <$network>"
}
@enduml
```



```

@startuml
scale .5
!include <osa/user/audit/audit>
'beware of 'hat-sprite'
!include <osa/user/black/hat/hat-sprite>
!include <osa/user/blue/blue>
!include <osa/user/blue/security/specialist/specialist>
!include <osa/user/blue/sysadmin/sysadmin>
!include <osa/user/blue/tester/tester>
!include <osa/user/blue/tie/tie>
!include <osa/user/green/architect/architect>
!include <osa/user/green/business/manager/manager>
!include <osa/user/green/developer/developer>
!include <osa/user/green/green>
!include <osa/user/green/operations/operations>
!include <osa/user/green/project/manager/manager>
!include <osa/user/green/service/manager/manager>
!include <osa/user/green/warning/warning>
!include <osa/user/large/group/group>
!include <osa/users/blue/green/green>
!include <osa/user/white/hat/hat>

```

```
listsprites
```



@enduml

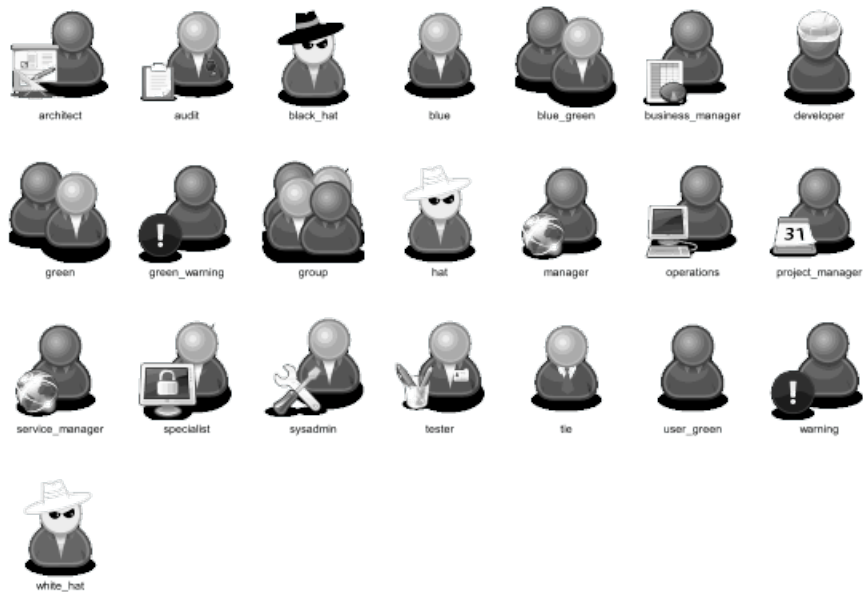

## 27.14 Tupadr3 library [tupadr3]

Type	Link
stdlib	<a href="https://github.com/plantuml/plantuml-stdlib/tree/master/tupadr3">https://github.com/plantuml/plantuml-stdlib/tree/master/tupadr3</a>
src	<a href="https://github.com/tupadr3/plantuml-icon-font-sprites">https://github.com/tupadr3/plantuml-icon-font-sprites</a>
orig	<a href="https://github.com/tupadr3/plantuml-icon-font-sprites#icon-sets">https://github.com/tupadr3/plantuml-icon-font-sprites#icon-sets</a>

This library contains several libraries of icons (including Devicons and Font Awesome).

Use it by including the file that contains the sprite, eg: `!include <font-awesome/align_center>`.  
When imported, you can use the sprite as normally you would, using `<$sprite_name>`.

You may also include the `common.puml` file, eg: `!include <font-awesome/common>`, which contains helper macros defined. With the `common.puml` imported, you can use the `NAME_OF_SPRITE(parameters...)` macro.

Example of usage:

```
@startuml
!include <tupadr3/common>
!include <tupadr3/font-awesome/server>
!include <tupadr3/font-awesome/database>

title Styling example

FA_SERVER(web1,web1) #Green
FA_SERVER(web2,web2) #Yellow
FA_SERVER(web3,web3) #Blue
FA_SERVER(web4,web4) #YellowGreen

FA_DATABASE(db1,LIVE,database,white) #RoyalBlue
FA_DATABASE(db2,SPARE,database) #Red

db1 <--> db2

web1 <--> db1
web2 <--> db1
web3 <--> db1
web4 <--> db1
```



```
@enduml
```

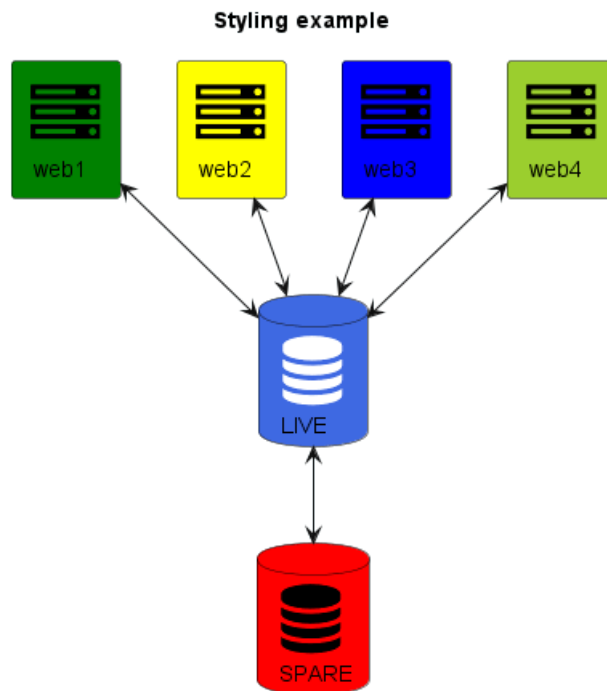

```
@startuml
!include <tupadr3/common>
!include <tupadr3/devicons/mysql>
```

```
DEV_MYSQL(db1)
DEV_MYSQL(db2,label of db2)
DEV_MYSQL(db3,label of db3,database)
DEV_MYSQL(db4,label of db4,database,red) #DeepSkyBlue
@enduml
```

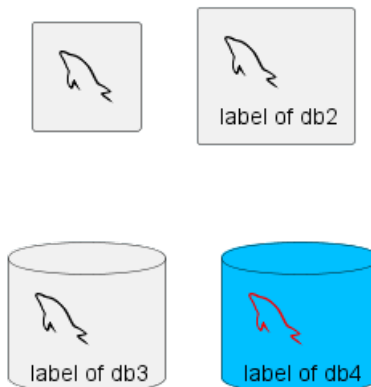

## 27.15 AWS library [aws]

Type	Link
stdlib	<a href="https://github.com/plantuml/plantuml-stdlib/tree/master/aws">https://github.com/plantuml/plantuml-stdlib/tree/master/aws</a>
src	<a href="https://github.com/milo-minderbinder/AWS-PlantUML">https://github.com/milo-minderbinder/AWS-PlantUML</a>
orig	<a href="https://aws.amazon.com/en/architecture/icons/">https://aws.amazon.com/en/architecture/icons/</a>

**Warning: We are thinking about deprecating this library.**

So you should probably use `<awslib>` instead (see above).





hr

The AWS library consists of Amazon AWS icons, it provides icons of two different sizes (normal and large).

Use it by including the file that contains the sprite, eg: `!include <aws/Storage/AmazonS3/AmazonS3>`. When imported, you can use the sprite as normally you would, using `<$sprite_name>`.

You may also include the `common.puml` file, eg: `!include <aws/common>`, which contains helper macros defined. With the `common.puml` imported, you can use the `NAME_OF_SPRITE(parameters...)` macro.

Example of usage:

```
@startuml
!include <aws/common>
!include <aws/Storage/AmazonS3/AmazonS3>
```

```
AMAZONS3(s3_internal)
AMAZONS3(s3_partner, "Vendor's S3")
s3_internal <- s3_partner
@enduml
```

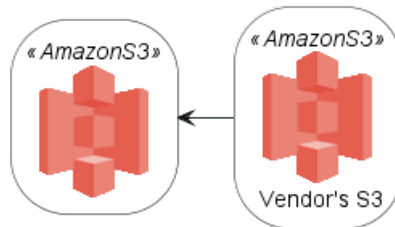

## Contents

<b>1</b>	<b>Sequence Diagram</b>	<b>1</b>
1.1	Basic Examples . . . . .	1
1.2	Declaring participant . . . . .	2
1.3	Declaring participant on multiline . . . . .	4
1.4	Use non-letters in participants . . . . .	4
1.5	Message to Self . . . . .	5
1.6	Text alignment . . . . .	5
1.6.1	Text of response message below the arrow . . . . .	5
1.7	Change arrow style . . . . .	6
1.8	Change arrow color . . . . .	6
1.9	Message sequence numbering . . . . .	7
1.10	Page Title, Header and Footer . . . . .	10
1.11	Splitting diagrams . . . . .	11
1.12	Grouping message . . . . .	11
1.13	Secondary group label . . . . .	12
1.14	Notes on messages . . . . .	13
1.15	Some other notes . . . . .	14
1.16	Changing notes shape [hnote, rnote] . . . . .	15
1.17	Note over all participants [across] . . . . .	15
1.18	Several notes aligned at the same level [/] . . . . .	16
1.19	Creole and HTML . . . . .	17
1.20	Divider or separator . . . . .	18
1.21	Reference . . . . .	18
1.22	Delay . . . . .	19
1.23	Text wrapping . . . . .	19
1.24	Space . . . . .	20
1.25	Lifeline Activation and Destruction . . . . .	20
1.26	Return . . . . .	22
1.27	Participant creation . . . . .	23
1.28	Shortcut syntax for activation, deactivation, creation . . . . .	23
1.29	Incoming and outgoing messages . . . . .	25
1.30	Short arrows for incoming and outgoing messages . . . . .	26
1.31	Anchors and Duration . . . . .	27
1.32	Stereotypes and Spots . . . . .	27
1.33	More information on titles . . . . .	28
1.34	Participants encompass . . . . .	30
1.35	Removing Foot Boxes . . . . .	31
1.36	Skinparam . . . . .	31
1.37	Changing padding . . . . .	33
1.38	Appendix: Examples of all arrow type . . . . .	34
1.38.1	Normal arrow . . . . .	34
1.38.2	Itself arrow . . . . .	35
1.38.3	Incoming and outgoing messages (with '[' , ']') . . . . .	36
1.38.4	Incoming messages (with '[') . . . . .	36
1.38.5	Outgoing messages (with ']') . . . . .	38
1.38.6	Short incoming and outgoing messages (with '??') . . . . .	39
1.38.7	Short incoming (with '?') . . . . .	39
1.38.8	Short outgoing (with '?') . . . . .	40
1.39	Specific SkinParameter . . . . .	42
1.39.1	By default . . . . .	42
1.39.2	LifelineStrategy . . . . .	42
1.39.3	style strictuml . . . . .	42
1.40	Hide unlinked participant . . . . .	43
1.41	Color a group message . . . . .	43
1.42	Mainframe . . . . .	44
1.43	Slanted or odd arrows . . . . .	44



<b>2</b>	<b>Use Case Diagram</b>	<b>47</b>
2.1	Usecases . . . . .	47
2.2	Actors . . . . .	47
2.3	Change Actor style . . . . .	48
2.3.1	Stick man ( <i>by default</i> ) . . . . .	48
2.3.2	Awesome man . . . . .	48
2.3.3	Hollow man . . . . .	49
2.4	Usecases description . . . . .	49
2.5	Use package . . . . .	50
2.6	Basic example . . . . .	51
2.7	Extension . . . . .	51
2.8	Using notes . . . . .	52
2.9	Stereotypes . . . . .	52
2.10	Changing arrows direction . . . . .	53
2.11	Splitting diagrams . . . . .	54
2.12	Left to right direction . . . . .	55
2.13	Skinparam . . . . .	55
2.14	Complete example . . . . .	56
2.15	Business Use Case . . . . .	57
2.15.1	Business Usecase . . . . .	57
2.15.2	Business Actor . . . . .	57
2.16	Change arrow color and style (inline style) . . . . .	58
2.17	Change element color and style (inline style) . . . . .	58
2.18	Display JSON Data on Usecase diagram . . . . .	59
2.18.1	Simple example . . . . .	59
<b>3</b>	<b>Class Diagram</b>	<b>60</b>
3.1	Declaring element . . . . .	60
3.2	Relations between classes . . . . .	61
3.3	Label on relations . . . . .	62
3.4	Using non-letters in element names and relation labels . . . . .	62
3.4.1	Starting names with \$ . . . . .	63
3.5	Adding methods . . . . .	63
3.6	Defining visibility . . . . .	64
3.7	Abstract and Static . . . . .	66
3.8	Advanced class body . . . . .	66
3.9	Notes and stereotypes . . . . .	67
3.10	More on notes . . . . .	68
3.11	Note on field (field, attribute, member) or method . . . . .	69
3.11.1	Constraint . . . . .	69
3.11.2	Note on field or method . . . . .	69
3.11.3	Note on method with the same name . . . . .	69
3.12	Note on links . . . . .	70
3.13	Abstract class and interface . . . . .	70
3.14	Hide attributes, methods... . . . .	71
3.15	Hide classes . . . . .	72
3.16	Remove classes . . . . .	73
3.17	Hide, Remove or Restore tagged element or wildcard . . . . .	73
3.18	Hide or Remove unlinked class . . . . .	75
3.19	Use generics . . . . .	76
3.20	Specific Spot . . . . .	76
3.21	Packages . . . . .	76
3.22	Packages style . . . . .	77
3.23	Namespaces . . . . .	78
3.24	Automatic package creation . . . . .	78
3.25	Lollipop interface . . . . .	79
3.26	Changing arrows orientation . . . . .	79
3.27	Association classes . . . . .	81



3.28	Association on same class	82
3.29	Skinparam	82
3.30	Skinned Stereotypes	83
3.31	Color gradient	83
3.32	Help on layout	84
3.33	Splitting large files	85
3.34	Extends and implements	86
3.35	Bracketed relations (linking or arrow) style	86
3.35.1	Line style	86
3.35.2	Line color	87
3.35.3	Line thickness	88
3.35.4	Mix	89
3.36	Change relation (linking or arrow) color and style (inline style)	89
3.37	Change class color and style (inline style)	89
3.38	Arrows from/to class members	91
3.39	Grouping inheritance arrow heads	92
3.39.1	GroupInheritance 1 (no grouping)	92
3.39.2	GroupInheritance 2 (grouping from 2)	92
3.39.3	GroupInheritance 3 (grouping only from 3)	93
3.39.4	GroupInheritance 4 (grouping only from 4)	93
3.40	Display JSON Data on Class or Object diagram	94
3.40.1	Simple example	94
3.41	Packages and Namespaces Enhancement	95
<b>4</b>	<b>Object Diagram</b>	<b>97</b>
4.1	Definition of objects	97
4.2	Relations between objects	97
4.3	Associations objects	98
4.4	Adding fields	98
4.5	Common features with class diagrams	99
4.6	Map table or associative array	99
4.7	Program (or project) evaluation and review technique (PERT) with map	102
4.8	Display JSON Data on Class or Object diagram	103
4.8.1	Simple example	103
<b>5</b>	<b>Activity Diagram (legacy)</b>	<b>104</b>
5.1	Simple Action	104
5.2	Label on arrows	104
5.3	Changing arrow direction	104
5.4	Branches	105
5.5	More on Branches	106
5.6	Synchronization	107
5.7	Long action description	108
5.8	Notes	108
5.9	Partition	109
5.10	Skinparam	110
5.11	Octagon	111
5.12	Complete example	111
<b>6</b>	<b>Activity Diagram (New Syntax)</b>	<b>114</b>
6.0.1	Benefits of the New Syntax	114
6.0.2	Transition to the New Syntax	114
6.1	Simple action	114
6.2	Start/Stop/End	114
6.3	Conditional	115
6.3.1	Several tests (horizontal mode)	116
6.3.2	Several tests (vertical mode)	117
6.4	Switch and case [switch, case, endswitch]	118
6.5	Conditional with stop on an action [kill, detach]	119

6.6	Repeat loop . . . . .	120
6.6.1	Simple repeat loop . . . . .	120
6.6.2	Repeat loop with repeat action and backward action . . . . .	120
6.7	Break on a repeat loop [break] . . . . .	121
6.8	Goto and Label Processing [label, goto] . . . . .	122
6.9	While loop . . . . .	123
6.9.1	Simple while loop . . . . .	123
6.9.2	While loop with backward action . . . . .	124
6.9.3	Infinite while loop . . . . .	124
6.10	Parallel processing [fork, fork again, end fork, end merge] . . . . .	125
6.10.1	Simple <code>fork</code> . . . . .	125
6.10.2	<code>fork</code> with end merge . . . . .	125
6.10.3	Label on <code>end fork</code> (or UML joinspec): . . . . .	126
6.10.4	Other example . . . . .	127
6.11	Split processing . . . . .	128
6.11.1	Split . . . . .	128
6.11.2	Input split (multi-start) . . . . .	128
6.11.3	Output split (multi-end) . . . . .	129
6.12	Notes . . . . .	130
6.13	Colors . . . . .	132
6.14	Lines without arrows . . . . .	133
6.15	Arrows . . . . .	133
6.16	Connector . . . . .	134
6.17	Color on connector . . . . .	134
6.18	Grouping or partition . . . . .	135
6.18.1	Group . . . . .	135
6.18.2	Partition . . . . .	136
6.18.3	Group, Partition, Package, Rectangle or Card . . . . .	138
6.19	Swimlanes . . . . .	139
6.20	Detach or kill [detach, kill] . . . . .	142
6.21	SDL (Specification and Description Language) . . . . .	143
6.21.1	Table of SDL Shape Name . . . . .	143
6.21.2	SDL using final separator (Deprecated form) . . . . .	143
6.21.3	SDL using Normal separator and Stereotype (Current official form) . . . . .	145
6.22	Complete example . . . . .	146
6.23	Condition Style . . . . .	148
6.23.1	Inside style (by default) . . . . .	148
6.23.2	Diamond style . . . . .	149
6.23.3	InsideDiamond (or <i>Foo1</i> ) style . . . . .	150
6.24	Condition End Style . . . . .	151
6.24.1	Diamond style (by default) . . . . .	151
6.24.2	Horizontal line (hline) style . . . . .	152
6.25	Using (global) style . . . . .	153
6.25.1	Without style ( <i>by default</i> ) . . . . .	153
6.25.2	With style . . . . .	153
<b>7</b>	<b>Component Diagram</b> . . . . .	<b>156</b>
7.1	Components . . . . .	156
7.1.1	Naming exceptions . . . . .	156
7.2	Interfaces . . . . .	157
7.3	Basic example . . . . .	157
7.4	Using notes . . . . .	157
7.5	Grouping Components . . . . .	159
7.6	Changing arrows direction . . . . .	160
7.7	Use UML2 notation . . . . .	162
7.8	Use UML1 notation . . . . .	162
7.9	Use rectangle notation (remove UML notation) . . . . .	163
7.10	Long description . . . . .	163

7.11	Individual colors . . . . .	163
7.12	Using Sprite in Stereotype . . . . .	163
7.13	Skinparam . . . . .	164
7.14	Specific SkinParameter . . . . .	166
7.14.1	componentStyle . . . . .	166
7.15	Hide or Remove unlinked component . . . . .	167
7.16	Hide, Remove or Restore tagged component or wildcard . . . . .	168
7.17	Display JSON Data on Component diagram . . . . .	170
7.17.1	Simple example . . . . .	170
7.18	Port [port, portIn, portOut] . . . . .	170
7.18.1	Port . . . . .	170
7.18.2	PortIn . . . . .	171
7.18.3	PortOut . . . . .	171
7.18.4	Mixing PortIn & PortOut . . . . .	172
<b>8</b>	<b>Deployment Diagram</b>	<b>174</b>
8.1	Declaring element . . . . .	174
8.2	Declaring element (using short form) . . . . .	176
8.2.1	Actor . . . . .	176
8.2.2	Component . . . . .	177
8.2.3	Interface . . . . .	177
8.2.4	Usecase . . . . .	177
8.3	Linking or arrow . . . . .	177
8.4	Bracketed arrow style . . . . .	180
8.4.1	Line style . . . . .	180
8.4.2	Line color . . . . .	181
8.4.3	Line thickness . . . . .	181
8.4.4	Mix . . . . .	182
8.5	Change arrow color and style (inline style) . . . . .	182
8.6	Change element color and style (inline style) . . . . .	183
8.7	Nestable elements . . . . .	184
8.8	Packages and nested elements . . . . .	184
8.8.1	Example with one level . . . . .	184
8.8.2	Other example . . . . .	185
8.8.3	Full nesting . . . . .	186
8.9	Alias . . . . .	190
8.9.1	Simple alias with <b>as</b> . . . . .	190
8.9.2	Examples of long alias . . . . .	191
8.10	Round corner . . . . .	193
8.11	Specific SkinParameter . . . . .	193
8.11.1	roundCorner . . . . .	193
8.12	Appendix: All type of arrow line . . . . .	194
8.13	Appendix: All type of arrow head or '0' arrow . . . . .	195
8.13.1	Type of arrow head . . . . .	195
8.13.2	Type of '0' arrow or circle arrow . . . . .	196
8.14	Appendix: Test of inline style on all element . . . . .	197
8.14.1	Simple element . . . . .	197
8.14.2	Nested element . . . . .	198
8.14.3	Without sub-element . . . . .	198
8.14.4	With sub-element . . . . .	199
8.15	Appendix: Test of style on all element . . . . .	200
8.15.1	Simple element . . . . .	200
8.15.2	Global style (on componentDiagram) . . . . .	200
8.15.3	Style for each element . . . . .	201
8.15.4	Nested element (without level) . . . . .	205
8.15.5	Global style (on componentDiagram) . . . . .	205
8.15.6	Style for each nested element . . . . .	205
8.15.7	Nested element (with one level) . . . . .	207



8.15.8	Global style (on componentDiagram)	207
8.15.9	Style for each nested element	208
8.16	Appendix: Test of stereotype with style on all element	211
8.16.1	Simple element	211
8.17	Display JSON Data on Deployment diagram	212
8.17.1	Simple example	212
8.18	Mixing Deployment (Usecase, Component, Deployment) element within a Class or Object diagram	213
8.18.1	Mixing all elements	213
8.19	Port [port, portIn, portOut]	215
8.19.1	Port	215
8.19.2	PortIn	216
8.19.3	PortOut	216
8.19.4	Mixing PortIn & PortOut	217
<b>9</b>	<b>State Diagram</b>	<b>219</b>
9.1	Simple State	219
9.2	Change state rendering	219
9.3	Composite state	220
9.3.1	Internal sub-state	220
9.3.2	Sub-state to sub-state	221
9.4	Long name	222
9.5	History [[H], [H*]]	223
9.6	Fork [fork, join]	223
9.7	Concurrent state [-,   ]	224
9.7.1	Horizontal separator --	224
9.7.2	Vertical separator	225
9.8	Conditional [choice]	226
9.9	Stereotypes full example [start, choice, fork, join, end]	226
9.10	Point [entryPoint, exitPoint]	227
9.11	Pin [inputPin, outputPin]	228
9.12	Expansion [expansionInput, expansionOutput]	229
9.13	Arrow direction	230
9.14	Change line color and style	231
9.15	Note	231
9.16	Note on link	232
9.17	More in notes	232
9.18	Inline color	233
9.19	Skinparam	234
9.19.1	Test of all specific skinparam to State Diagrams	235
9.20	Changing style	235
9.21	Change state color and style (inline style)	237
9.22	Alias	238
9.23	Display JSON Data on State diagram	239
9.23.1	Simple example	239
<b>10</b>	<b>Timing Diagram</b>	<b>240</b>
10.1	Declaring element or participant	240
10.2	Binary and Clock	241
10.3	Adding message	241
10.4	Relative time	242
10.5	Anchor Points	243
10.6	Participant oriented	243
10.7	Setting scale	244
10.8	Initial state	245
10.9	Intricated state	245
10.9.1	Intricated or undefined robust state	245
10.9.2	Intricated or undefined binary state	246
10.10	Hidden state	246



10.11	Hide time axis . . . . .	248
10.12	Using Time and Date . . . . .	248
10.13	Adding constraint . . . . .	249
10.14	Highlighted period . . . . .	249
10.15	Using notes . . . . .	250
10.16	Adding texts . . . . .	251
10.17	Complete example . . . . .	252
10.18	Digital Example . . . . .	253
10.19	Adding color . . . . .	254
10.20	Using (global) style . . . . .	255
10.20.1	Without style ( <i>by default</i> ) . . . . .	255
10.20.2	With style . . . . .	255
10.21	Applying Colors to specific lines . . . . .	256
10.22	Compact mode . . . . .	257
10.22.1	By default . . . . .	257
10.22.2	Global mode with <code>mode compact</code> . . . . .	258
10.22.3	Local mode with only <code>compact</code> on element . . . . .	258
<b>11</b>	<b>Display JSON Data</b>	<b>260</b>
11.1	Complex example . . . . .	260
11.2	Highlight parts . . . . .	261
11.3	Using different styles for highlight . . . . .	261
11.4	JSON basic element . . . . .	262
11.4.1	Synthesis of all JSON basic element . . . . .	262
11.5	JSON array or table . . . . .	263
11.5.1	Array type . . . . .	263
11.5.2	Minimal array or table . . . . .	264
11.5.3	Number array . . . . .	264
11.5.4	String array . . . . .	264
11.5.5	Boolean array . . . . .	264
11.6	JSON numbers . . . . .	264
11.7	JSON strings . . . . .	265
11.7.1	JSON Unicode . . . . .	265
11.7.2	JSON two-character escape sequence . . . . .	265
11.8	Minimal JSON examples . . . . .	266
11.9	Empty table or list . . . . .	267
11.10	Using (global) style . . . . .	267
11.10.1	Without style ( <i>by default</i> ) . . . . .	267
11.10.2	With style . . . . .	268
11.11	Display JSON Data on Class or Object diagram . . . . .	269
11.11.1	Simple example . . . . .	269
11.11.2	Complex example: with all JSON basic element . . . . .	269
11.12	Display JSON Data on Deployment (Usecase, Component, Deployment) diagram . . . . .	270
11.12.1	Simple example . . . . .	270
11.13	Display JSON Data on State diagram . . . . .	271
11.13.1	Simple example . . . . .	271
<b>12</b>	<b>Display YAML Data</b>	<b>273</b>
12.1	Complex example . . . . .	273
12.2	Specific key (with symbols or unicode) . . . . .	274
12.3	Highlight parts . . . . .	274
12.3.1	Normal style . . . . .	274
12.3.2	Customised style . . . . .	275
12.4	Using different styles for highlight . . . . .	275
12.5	Using (global) style . . . . .	276
12.5.1	Without style ( <i>by default</i> ) . . . . .	276
12.5.2	With style . . . . .	277
<b>13</b>	<b>Network diagram (nwdiag)</b>	<b>279</b>





13.1	Simple diagram	279
13.1.1	Define a network	279
13.1.2	Define some elements or servers on a network	279
13.1.3	Full example	279
13.2	Define multiple addresses	280
13.3	Grouping nodes	281
13.3.1	Define group inside network definitions	281
13.3.2	Define group outside of network definitions	281
13.3.3	Define several groups on same network	282
13.3.4	Example with 2 group	282
13.3.5	Example with 3 groups	283
13.4	Extended Syntax (for network or group)	284
13.4.1	Network	284
13.4.2	Group	285
13.5	Using Sprites	286
13.6	Using OpenIconic	287
13.7	Same nodes on more than two networks	288
13.8	Peer networks	289
13.9	Peer networks and group	289
13.9.1	Without group	289
13.9.2	Group on first	290
13.9.3	Group on second	291
13.9.4	Group on third	292
13.10	Add title, caption, header, footer or legend on network diagram	293
13.11	With or without shadow	294
13.11.1	With shadow (by default)	294
13.11.2	Without shadow	294
13.12	Change width of the networks	295
13.13	Other internal networks	298
13.14	Using (global) style	299
13.14.1	Without style ( <i>by default</i> )	299
13.14.2	With style	300
13.15	Appendix: Test of all shapes on Network diagram (nwdiag)	301
<b>14</b>	<b>Salt (Wireframe)</b>	<b>304</b>
14.1	Basic widgets	304
14.2	Text area	304
14.3	Open, close droplist	305
14.4	Using grid [   and #, !, -, + ]	305
14.5	Group box [ ^ ]	306
14.6	Using separator [ .., ==, ~~, - ]	306
14.7	Tree widget [ T ]	307
14.8	Tree table [ T ]	307
14.9	Enclosing brackets [ {, } ]	309
14.10	Adding tabs [ / ]	309
14.11	Using menu [ * ]	310
14.12	Advanced table	311
14.13	Scroll Bars [ S, SI, S- ]	312
14.14	Colors	312
14.15	Creole on Salt	313
14.16	Pseudo sprite [ «, » ]	315
14.17	OpenIconic	315
14.18	Add title, header, footer, caption or legend	316
14.19	Zoom, DPI	317
14.19.1	Whitout zoom (by default)	317
14.19.2	Scale	317
14.19.3	DPI	317
14.20	Include Salt "on activity diagram"	318

14.21	Include salt "on while condition of activity diagram"	320
14.22	Include salt "on repeat while condition of activity diagram"	321
14.23	Skinparam	322
14.24	Style	323
<b>15</b>	<b>Archimate Diagram</b>	<b>324</b>
15.1	Archimate keyword	324
15.2	Defining Junctions	324
15.3	Example 1	325
15.4	Example 2	326
15.5	List possible sprites	327
15.6	ArchiMate Macros	327
15.6.1	Archimate Macros and Library	327
15.6.2	Archimate elements	327
15.6.3	Archimate relationships	328
15.6.4	Appendice: Examples of all Archimate RelationTypes	329
<b>16</b>	<b>Gantt Diagram</b>	<b>333</b>
16.1	Declaring tasks	333
16.1.1	Duration	333
16.1.2	Start	333
16.1.3	End	334
16.1.4	Start/End	334
16.2	One-line declaration (with the and conjunction)	335
16.3	Adding constraints	335
16.4	Short names	335
16.5	Customize colors	336
16.6	Completion status	336
16.6.1	Adding completion depending percentage	336
16.6.2	Change colour of completion (by style)	336
16.7	Milestone	337
16.7.1	Relative milestone (use of constraints)	338
16.7.2	Absolute milestone (use of fixed date)	338
16.7.3	Milestone of maximum end of tasks	338
16.8	Hyperlinks	338
16.9	Calendar	339
16.10	Coloring days	339
16.11	Changing scale	339
16.11.1	Daily ( <i>by default</i> )	340
16.11.2	Weekly	340
16.11.3	Monthly	341
16.11.4	Quarterly	341
16.11.5	Yearly	342
16.12	Zoom (example for all scale)	342
16.12.1	Zoom on weekly scale	342
16.12.2	Without zoom	342
16.12.3	With zoom	342
16.12.4	Zoom on weekly scale	343
16.12.5	Without zoom	343
16.12.6	With zoom	343
16.12.7	Zoom on monthly scale	344
16.12.8	Without zoom	344
16.12.9	With zoom	344
16.12.10	Zoom on quarterly scale	344
16.12.11	Without zoom	344
16.12.12	With zoom	345
16.12.13	Zoom on yearly scale	345
16.12.14	Without zoom	345
16.12.15	With zoom	345



16.13	Weekscale with Weeknumbers or Calendar Date . . . . .	346
16.13.1	With Weeknumbers ( <i>by default</i> ) . . . . .	346
16.13.2	With Calendar Date . . . . .	346
16.14	Close day . . . . .	346
16.15	Definition of a week depending of closed days . . . . .	347
16.16	Working days . . . . .	348
16.17	Simplified task succession . . . . .	348
16.18	Working with resources . . . . .	349
16.19	Hide resources . . . . .	349
16.19.1	Without any hiding ( <i>by default</i> ) . . . . .	349
16.19.2	Hide resources names . . . . .	350
16.19.3	Hide resources footbox . . . . .	350
16.19.4	Hide the both (resources names and resources footbox) . . . . .	350
16.20	Horizontal Separator . . . . .	351
16.21	Vertical Separator . . . . .	351
16.22	Complex example . . . . .	351
16.23	Comments . . . . .	352
16.24	Using style . . . . .	352
16.24.1	Without style ( <i>by default</i> ) . . . . .	352
16.24.2	With style . . . . .	353
16.24.3	With style (full example) . . . . .	354
16.24.4	Clean style . . . . .	356
16.25	Add notes . . . . .	357
16.26	Pause tasks . . . . .	359
16.27	Change link colors . . . . .	360
16.28	Tasks or Milestones on the same line . . . . .	361
16.29	Highlight today . . . . .	361
16.30	Task between two milestones . . . . .	361
16.31	Grammar and verbal form . . . . .	362
16.32	Add title, header, footer, caption or legend . . . . .	362
16.33	Removing Foot Boxes (example for all scale) . . . . .	362
16.34	Language of the calendar . . . . .	364
16.34.1	English ( <i>en, by default</i> ) . . . . .	364
16.34.2	Deutsch (de) . . . . .	365
16.34.3	Japanese (ja) . . . . .	365
16.34.4	Chinese (zh) . . . . .	365
16.34.5	Korean (ko) . . . . .	366
16.35	Delete Tasks or Milestones . . . . .	366
16.36	Start a project, a task or a milestone a number of days before or after today . . . . .	367
16.37	Change Label position . . . . .	367
16.37.1	The labels are near elements ( <i>by default</i> ) . . . . .	367
16.37.2	Label on first column . . . . .	368
16.37.3	Label on last column . . . . .	369
<b>17</b>	<b>MindMap</b> . . . . .	<b>371</b>
17.1	OrgMode syntax . . . . .	371
17.2	Markdown syntax . . . . .	371
17.3	Arithmetic notation . . . . .	372
17.4	Multilines . . . . .	372
17.5	Multiroot Mindmap . . . . .	374
17.6	Colors . . . . .	374
17.6.1	With inline color . . . . .	374
17.6.2	With style color . . . . .	375
17.7	Removing box . . . . .	377
17.8	Changing diagram direction . . . . .	378
17.9	Complete example . . . . .	379
17.10	Changing style . . . . .	380
17.10.1	node, depth . . . . .	380

17.10.2 boxless . . . . .	381
17.11 Word Wrap . . . . .	381
17.12 Creole on Mindmap diagram . . . . .	382
<b>18 Work Breakdown Structure (WBS)</b>	<b>385</b>
18.1 OrgMode syntax . . . . .	385
18.2 Change direction . . . . .	385
18.3 Arithmetic notation . . . . .	386
18.4 Multilines . . . . .	386
18.5 Removing box . . . . .	387
18.5.1 Boxless on Arithmetic notation . . . . .	387
18.5.2 Several boxless node . . . . .	387
18.5.3 All boxless node . . . . .	388
18.5.4 Boxless on OrgMode syntax . . . . .	388
18.5.5 Several boxless node . . . . .	388
18.5.6 All boxless node . . . . .	389
18.6 Colors (with inline or style color) . . . . .	389
18.7 Using style . . . . .	391
18.8 Word Wrap . . . . .	392
18.9 Add arrows between WBS elements . . . . .	393
18.10 Creole on WBS diagram . . . . .	394
<b>19 Maths</b>	<b>397</b>
19.1 Standalone diagram . . . . .	398
19.2 How is this working? . . . . .	398
<b>20 Entity Relationship Diagram</b>	<b>399</b>
20.1 Information Engineering Relations . . . . .	399
20.2 Entities . . . . .	399
20.3 Complete Example . . . . .	400
<b>21 Common Commands in PlantUML</b>	<b>402</b>
21.0.1 Global Elements . . . . .	402
21.0.2 Creole Syntax Description . . . . .	402
21.0.3 Style Control Command . . . . .	402
21.1 Comments . . . . .	402
21.1.1 Simple comment . . . . .	402
21.1.2 Block comment . . . . .	402
21.1.3 Full example . . . . .	403
21.2 Zoom . . . . .	403
21.3 Title . . . . .	404
21.4 Caption . . . . .	405
21.5 Footer and header . . . . .	405
21.6 Legend the diagram . . . . .	406
21.7 Appendix: Examples on all diagram . . . . .	406
21.7.1 Activity . . . . .	406
21.7.2 Archimate . . . . .	407
21.7.3 Class . . . . .	408
21.7.4 Component, Deployment, Use-Case . . . . .	408
21.7.5 Gantt project planning . . . . .	409
21.7.6 Object . . . . .	409
21.7.7 MindMap . . . . .	410
21.7.8 Network (nwdiag) . . . . .	411
21.7.9 Sequence . . . . .	411
21.7.10 State . . . . .	412
21.7.11 Timing . . . . .	413
21.7.12 Work Breakdown Structure (WBS) . . . . .	413
21.7.13 Wireframe (SALT) . . . . .	414
21.8 Appendix: Examples on all diagram with style . . . . .	415

21.8.1	Activity	415
21.8.2	Archimate	417
21.8.3	Class	418
21.8.4	Component, Deployment, Use-Case	420
21.8.5	Gantt project planning	421
21.8.6	Object	423
21.8.7	MindMap	424
21.8.8	Network (nwdiag)	425
21.8.9	Sequence	427
21.8.10	State	428
21.8.11	Timing	430
21.8.12	Work Breakdown Structure (WBS)	431
21.8.13	Wireframe (SALT)	432
21.9	Mainframe	433
21.10	Appendix: Examples of Mainframe on all diagram	434
21.10.1	Activity	434
21.10.2	Archimate	434
21.10.3	Class	435
21.10.4	Component, Deployment, Use-Case	435
21.10.5	Gantt project planning	435
21.10.6	Object	436
21.10.7	MindMap	436
21.10.8	Network (nwdiag)	436
21.10.9	Sequence	437
21.10.10	State	437
21.10.11	Timing	437
21.10.12	Work Breakdown Structure (WBS)	438
21.10.13	Wireframe (SALT)	438
21.11	Appendix: Examples of title, header, footer, caption, legend and mainframe on all diagram	439
21.11.1	Activity	439
21.11.2	Archimate	439
21.11.3	Class	440
21.11.4	Component, Deployment, Use-Case	441
21.11.5	Gantt project planning	441
21.11.6	Object	442
21.11.7	MindMap	443
21.11.8	Network (nwdiag)	443
21.11.9	Sequence	444
21.11.10	State	445
21.11.11	Timing	445
21.11.12	Work Breakdown Structure (WBS)	446
21.11.13	Wireframe (SALT)	447
<b>22</b>	<b>Creole</b>	<b>449</b>
22.1	Emphasized text	449
22.2	Lists	449
22.3	Escape character	450
22.4	Headings	450
22.5	Emoji	451
22.5.1	Unicode block 26	451
22.6	Horizontal lines	452
22.7	Links	453
22.8	Code	453
22.9	Table	454
22.9.1	Create a table	454
22.9.2	Add color on rows or cells	455
22.9.3	Add color on border and text	455
22.9.4	No border or same color as the background	455



22.9.5 Bold header or not . . . . .	455
22.10 Tree . . . . .	456
22.11 Special characters . . . . .	458
22.12 Legacy HTML . . . . .	459
22.12.1 Common HTML element . . . . .	460
22.12.2 Subscript and Superscript element [sub, sup] . . . . .	461
22.13 OpenIconic . . . . .	461
22.14 Appendix: Examples of "Creole List" on all diagrams . . . . .	462
22.14.1 Activity . . . . .	462
22.14.2 Class . . . . .	463
22.14.3 Component, Deployment, Use-Case . . . . .	464
22.14.4 Gantt project planning . . . . .	465
22.14.5 Object . . . . .	465
22.14.6 MindMap . . . . .	466
22.14.7 Network (nwdiag) . . . . .	466
22.14.8 Note . . . . .	467
22.14.9 Sequence . . . . .	467
22.14.10 State . . . . .	468
22.14.11 WBS . . . . .	469
22.15 Appendix: Examples of "Creole horizontal lines" on all diagrams . . . . .	470
22.15.1 Activity . . . . .	470
22.15.2 Class . . . . .	471
22.15.3 Component, Deployment, Use-Case . . . . .	471
22.15.4 Gantt project planning . . . . .	473
22.15.5 Object . . . . .	473
22.15.6 MindMap . . . . .	474
22.15.7 Network (nwdiag) . . . . .	474
22.15.8 Note . . . . .	475
22.15.9 Sequence . . . . .	475
22.15.10 State . . . . .	476
22.15.11 WBS . . . . .	477
22.16 Style equivalent (between Creole and HTML) . . . . .	478
<b>23 Defining and using sprites</b> . . . . .	<b>480</b>
23.1 Inline SVG sprite . . . . .	481
23.2 Changing colors . . . . .	481
23.3 Encoding Sprite . . . . .	482
23.4 Importing Sprite . . . . .	482
23.5 Examples . . . . .	482
23.6 StdLib . . . . .	483
23.7 Listing Sprites . . . . .	483
<b>24 Skinparam command</b> . . . . .	<b>485</b>
24.1 Usage . . . . .	485
24.2 Nested . . . . .	485
24.3 Black and White . . . . .	485
24.4 Shadowing . . . . .	486
24.5 Reverse colors . . . . .	486
24.6 Colors . . . . .	487
24.7 Font color, name and size . . . . .	488
24.8 Text Alignment . . . . .	488
24.9 Examples . . . . .	489
24.10 List of all skinparam parameters . . . . .	493
24.10.1 Command Line: -language command . . . . .	493
24.10.2 Command: help skinparams . . . . .	493
24.10.3 Command: skinparameters . . . . .	493
24.10.4 All Skin Parameters on the Ashley's PlantUML Doc . . . . .	495
<b>25 Preprocessing</b> . . . . .	<b>496</b>



25.1	Variable definition [=, ?=]	496
25.2	Boolean expression	497
25.2.1	Boolean representation [0 is false]	497
25.2.2	Boolean operation and operator [&&,   , ()]	497
25.2.3	Boolean builtin functions [%false(), %true(), %not(<exp>)]	497
25.3	Conditions [!if, !else, !elseif, !endif]	497
25.4	While loop [!while, !endwhile]	498
25.4.1	While loop (on Activity diagram)	498
25.4.2	While loop (on Mindmap diagram)	499
25.4.3	While loop (on Component/Deployment diagram)	500
25.5	Procedure [!procedure, !endprocedure]	500
25.6	Return function [!function, !endfunction]	501
25.7	Default argument value	502
25.8	Unquoted procedure or function [!unquoted]	503
25.9	Keywords arguments	504
25.10	Including files or URL [!include, !include_many, !include_once]	504
25.11	Including Subpart [!startsub, !endsub, !includesub]	505
25.12	Builtin functions [%]	505
25.13	Logging [!log]	506
25.14	Memory dump [!dump_memory]	507
25.15	Assertion [!assert]	507
25.16	Building custom library [!import, !include]	508
25.17	Search path	508
25.18	Argument concatenation [##]	508
25.19	Dynamic invocation [%invoke_procedure(), %call_user_func()]	509
25.20	Evaluation of addition depending of data types [+]	510
25.21	Preprocessing JSON	510
25.22	Including theme [!theme]	510
25.23	Migration notes	511
25.24	%Splitstr builtin function	511
<b>26</b>	<b>Unicode</b>	<b>512</b>
26.1	Examples	512
26.2	Charset	514
26.3	Using Unicode Character on PlantUML	514
<b>27</b>	<b>PlantUML Standard Library</b>	<b>515</b>
27.0.1	Standard Library Overview	515
27.0.2	Contribution from the Community	515
27.1	List of Standard Library	515
27.2	ArchiMate [archimate]	517
27.2.1	List possible sprites	518
27.3	Amazon Labs AWS Library [awslib]	519
27.4	Azure library [azure]	520
27.5	C4 Library [C4]	521
27.6	Cloud Insight [cloudinsight]	521
27.7	Cloudogu [cloudogu]	522
27.8	Elastic library [elastic]	523
27.9	Google Material Icons [material]	525
27.10	Kubernetes [kubernetes]	526
27.11	Logos [logos]	527
27.12	Office [office]	529
27.13	Open Security Architecture (OSA) [osa]	531
27.14	Tupadr3 library [tupadr3]	534
27.15	AWS library [aws]	535

