

SUSE Linux Enterprise Server

11 SP1

www.novell.com

August 17, 2010

Security Guide



Security Guide

All content is copyright © 2006–2010 Novell, Inc. All rights reserved.

Legal Notice

This manual is protected under Novell intellectual property rights. By reproducing, duplicating or distributing this manual you explicitly agree to conform to the terms and conditions of this license agreement.

This manual may be freely reproduced, duplicated and distributed either as such or as part of a bundled package in electronic and/or printed format, provided however that the following conditions are fulfilled:

That this copyright notice and the names of authors and contributors appear clearly and distinctively on all reproduced, duplicated and distributed copies. That this manual, specifically for the printed format, is reproduced and/or distributed for noncommercial use only. The express authorization of Novell, Inc must be obtained prior to any other use of any manual or part thereof.

For Novell trademarks, see the Novell Trademark and Service Mark list <http://www.novell.com/company/legal/trademarks/tmlist.html>. * Linux is a registered trademark of Linus Torvalds. All other third party trademarks are the property of their respective owners. A trademark symbol (®, ™ etc.) denotes a Novell trademark; an asterisk (*) denotes a third party trademark.

All information found in this book has been compiled with utmost attention to detail. However, this does not guarantee complete accuracy. Neither Novell, Inc., SUSE LINUX Products GmbH, the authors, nor the translators shall be held liable for possible errors or the consequences thereof.

Contents

About This Guide	xi
1 Security and Confidentiality	1
1.1 Local Security and Network Security	2
1.2 Some General Security Tips and Tricks	10
1.3 Using the Central Security Reporting Address	13
Part I Authentication	15
2 Authentication with PAM	17
2.1 What is PAM?	17
2.2 Structure of a PAM Configuration File	18
2.3 The PAM Configuration of sshd	21
2.4 Configuration of PAM Modules	23
2.5 Configuring PAM Using pam-config	25
2.6 For More Information	26
3 Using NIS	29
3.1 Configuring NIS Servers	29
3.2 Configuring NIS Clients	35
4 LDAP—A Directory Service	37
4.1 LDAP versus NIS	38
4.2 Structure of an LDAP Directory Tree	39
4.3 Configuring an LDAP Server with YaST	42
4.4 Configuring an LDAP Client with YaST	51

4.5	Configuring LDAP Users and Groups in YaST	59
4.6	Browsing the LDAP Directory Tree	61
4.7	Manually Configuring an LDAP Server	62
4.8	Manually Administering LDAP Data	63
4.9	For More Information	67
5	Active Directory Support	69
5.1	Integrating Linux and AD Environments	69
5.2	Background Information for Linux AD Support	70
5.3	Configuring a Linux Client for Active Directory	76
5.4	Logging In to an AD Domain	79
5.5	Changing Passwords	81
6	Network Authentication with Kerberos	83
6.1	Kerberos Terminology	84
6.2	How Kerberos Works	85
6.3	Users' View of Kerberos	88
6.4	Installing and Administering Kerberos	89
6.5	For More Information	110
7	Using the Fingerprint Reader	111
7.1	Supported Applications and Actions	111
7.2	Managing Fingerprints with YaST	112
Part II	Local Security	115
8	Configuring Security Settings with YaST	117
8.1	<i>Security Overview</i>	117
8.2	<i>Predefined Security Configurations</i>	118
8.3	<i>Password Settings</i>	119
8.4	Boot Settings	120
8.5	Login Settings	120
8.6	User Addition	121
8.7	Miscellaneous Settings	121
9	PolicyKit	123
9.1	Available Policies and Supported Applications	123
9.2	Authorization Types	124
9.3	Modifying and Setting Privileges	126

10	Access Control Lists in Linux	135
10.1	Traditional File Permissions	135
10.2	Advantages of ACLs	137
10.3	Definitions	137
10.4	Handling ACLs	138
10.5	ACL Support in Applications	146
10.6	For More Information	147
11	Encrypting Partitions and Files	149
11.1	Setting Up an Encrypted File System with YaST	150
11.2	Using Encrypted Home Directories	153
11.3	Using vi to Encrypt Single ASCII Text Files	154
12	Certificate Store	155
12.1	Activating Certificate Store	155
12.2	Importing Certificates	156
13	Intrusion Detection with AIDE	157
13.1	Why Using AIDE?	157
13.2	Setting Up an AIDE Database	158
13.3	Local AIDE Checks	160
13.4	System Independent Checking	161
13.5	For More Information	163
Part III	Network Security	165
14	SSH: Secure Network Operations	167
14.1	The OpenSSH Package	167
14.2	The ssh Program	168
14.3	scp—Secure Copy	168
14.4	sftp—Secure File Transfer	169
14.5	The SSH Daemon (sshd)—Server-Side	169
14.6	SSH Authentication Mechanisms	170
14.7	X, Authentication, and Forwarding Mechanisms	172
14.8	Configuring An SSH Daemon with YaST	173
15	Masquerading and Firewalls	175
15.1	Packet Filtering with iptables	175
15.2	Masquerading Basics	178

15.3	Firewalling Basics	179
15.4	SuSEfirewall2	180
15.5	For More Information	185
16	Configuring VPN Server	187
16.1	Overview	187
16.2	Creating the Simplest VPN Example	191
16.3	Setting Up Your VPN Server Using Certificate Authority	193
16.4	Changing Nameservers in VPN	199
16.5	KDE- and GNOME Applets For Clients	200
16.6	For More Information	202
17	Managing X.509 Certification	203
17.1	The Principles of Digital Certification	203
17.2	YaST Modules for CA Management	207
17.3	For More Information	219
Part IV	Confining Privileges with Novell AppArmor	221
18	Introducing AppArmor	223
18.1	Background Information on AppArmor Profiling	224
19	Getting Started	225
19.1	Installing Novell AppArmor	226
19.2	Enabling and Disabling Novell AppArmor	226
19.3	Choosing the Applications to Profile	227
19.4	Building and Modifying Profiles	228
19.5	Configuring Novell AppArmor Event Notification and Reports	230
19.6	Updating Your Profiles	232
20	Immunizing Programs	233
20.1	Introducing the AppArmor Framework	234
20.2	Determining Programs to Immunize	236
20.3	Immunizing cron Jobs	237
20.4	Immunizing Network Applications	238
21	Profile Components and Syntax	243
21.1	Breaking a Novell AppArmor Profile into Its Parts	244

21.2	Profile Types	247
21.3	#include Statements	250
21.4	Capability Entries (POSIX.1e)	251
21.5	Network Access Control	251
21.6	Paths and Globbing	252
21.7	File Permission Access Modes	255
21.8	Execute Modes	258
21.9	Resource Limit Control	263
21.10	Auditing Rules	264
21.11	Setting Capabilities per Profile	265
22	AppArmor Profile Repositories	267
22.1	Using the Local Repository	267
22.2	Using the External Repository	268
23	Building and Managing Profiles with YaST	271
23.1	Adding a Profile Using the Wizard	273
23.2	Manually Adding a Profile	281
23.3	Editing Profiles	281
23.4	Deleting a Profile	287
23.5	Updating Profiles from Log Entries	287
23.6	Managing Novell AppArmor and Security Event Status	288
24	Building Profiles from the Command Line	291
24.1	Checking the AppArmor Module Status	291
24.2	Building AppArmor Profiles	293
24.3	Adding or Creating an AppArmor Profile	294
24.4	Editing an AppArmor Profile	294
24.5	Deleting an AppArmor Profile	294
24.6	Two Methods of Profiling	295
24.7	Important Filenames and Directories	316
25	Profiling Your Web Applications Using ChangeHat	319
25.1	Apache ChangeHat	320
25.2	Configuring Apache for mod_apparmor	326

26	Confining Users with pam_apparmor	331
27	Managing Profiled Applications	333
27.1	Monitoring Your Secured Applications	333
27.2	Configuring Security Event Notification	334
27.3	Configuring Reports	337
27.4	Configuring and Using the AppArmor Desktop Monitor Applet	357
27.5	Reacting to Security Event Rejections	358
27.6	Maintaining Your Security Profiles	358
28	Support	361
28.1	Updating Novell AppArmor Online	361
28.2	Using the Man Pages	361
28.3	For More Information	363
28.4	Troubleshooting	364
28.5	Reporting Bugs for AppArmor	371
29	AppArmor Glossary	373
Part V	<i>The Linux Audit Framework</i>	377
30	Understanding Linux Audit	379
30.1	Introducing the Components of Linux Audit	382
30.2	Configuring the Audit Daemon	384
30.3	Controlling the Audit System Using auditctl	389
30.4	Passing Parameters to the Audit System	391
30.5	Understanding the Audit Logs and Generating Reports	395
30.6	Querying the Audit Daemon Logs with ausearch	407
30.7	Analyzing Processes with atrace	411
30.8	Visualizing Audit Data	412
30.9	Relaying Audit Event Notifications	414
31	Setting Up the Linux Audit Framework	419
31.1	Determining the Components to Audit	420
31.2	Configuring the Audit Daemon	421
31.3	Enabling Audit for System Calls	422
31.4	Setting Up Audit Rules	423
31.5	Configuring Audit Reports	425
31.6	Configuring Log Visualization	428

32	Introducing an Audit Rule Set	431
32.1	Adding Basic Audit Configuration Parameters	432
32.2	Adding Watches on Audit Log Files and Configuration Files	433
32.3	Monitoring File System Objects	434
32.4	Monitoring Security Configuration Files and Databases	435
32.5	Monitoring Miscellaneous System Calls	438
32.6	Filtering System Call Arguments	438
32.7	Managing Audit Event Records Using Keys	441
33	Useful Resources	443

About This Guide

This manual introduces the basic concepts of system security on SUSE Linux Enterprise Server. It covers extensive documentation about the authentication mechanisms available on Linux, such as NIS or LDAP. It also deals with aspects of local security like access control lists, encryption and intrusion detection. In the network security part you learn how to secure your computers with firewalls and masquerading, and how to set up virtual private networks (VPN). This manual also shows you how to make use of the product inherent security software like Novell AppArmor (which lets you specify per program which files the program may read, write, and execute) or the auditing system that reliably collects information about any security-relevant events.

Many chapters in this manual contain links to additional documentation resources. These include additional documentation that is available on the system, as well as documentation available on the Internet.

For an overview of the documentation available for your product and the latest documentation updates, refer to <http://www.novell.com/documentation> or to the following section.

1 Available Documentation

We provide HTML and PDF versions of our books in different languages. The following manuals for users and administrators are available on this product:

Deployment Guide (↑*Deployment Guide*)

Shows how to install single or multiple systems and how to exploit the product inherent capabilities for a deployment infrastructure. Choose from various approaches, ranging from a local installation or a network installation server to a mass deployment using a remote-controlled, highly-customized, and automated installation technique.

Administration Guide (↑*Administration Guide*)

Covers system administration tasks like maintaining, monitoring and customizing an initially installed system.

Security Guide (page 1)

Introduces basic concepts of system security, covering both local and network security aspects. Shows how to make use of the product inherent security software like Novell AppArmor (which lets you specify per program which files the program may read, write, and execute) or the auditing system that reliably collects information about any security-relevant events.

System Analysis and Tuning Guide (↑*System Analysis and Tuning Guide*)

An administrator's guide for problem detection, resolution and optimization. Find how to inspect and optimize your system by means of monitoring tools and how to efficiently manage resources. Also contains an overview of common problems and solutions and of additional help and documentation resources.

Virtualization with Xen (↑*Virtualization with Xen*)

Offers an introduction to virtualization technology of your product. It features an overview of the various fields of application and installation types of each of the platforms supported by SUSE Linux Enterprise Server as well as a short description of the installation procedure.

Storage Administration Guide

Provides information about how to manage storage devices on a SUSE Linux Enterprise Server.

In addition to the comprehensive manuals, several quick start guides are available:

Installation Quick Start (↑*Installation Quick Start*)

Lists the system requirements and guides you step-by-step through the installation of SUSE Linux Enterprise Server from DVD, or from an ISO image.

Linux Audit Quick Start

Gives a short overview how to enable and configure the auditing system and how to execute key tasks such as setting up audit rules, generating reports, and analyzing the log files.

Novell AppArmor Quick Start

Helps you understand the main concepts behind Novell® AppArmor.

Find HTML versions of most product manuals in your installed system under `/usr/share/doc/manual` or in the help centers of your desktop. Find the latest documentation updates at <http://www.novell.com/documentation> where you can download PDF or HTML versions of the manuals for your product.

2 Feedback

Several feedback channels are available:

Bugs and Enhancement Requests

For services and support options available for your product, refer to <http://www.novell.com/services/>.

To report bugs for a product component, please use <http://support.novell.com/additional/bugreport.html>.

Submit enhancement requests at <https://secure-www.novell.com/rms/rmsTool?action=ReqActions.viewAddPage&return=www>.

User Comments

We want to hear your comments and suggestions about this manual and the other documentation included with this product. Use the User Comments feature at the bottom of each page in the online documentation or go to <http://www.novell.com/documentation/feedback.html> and enter your comments there.

3 Documentation Conventions

The following typographical conventions are used in this manual:

- `/etc/passwd`: directory names and filenames
- *placeholder*: replace *placeholder* with the actual value
- `PATH`: the environment variable `PATH`
- `ls, --help`: commands, options, and parameters
- `user`: users or groups
- `Alt, Alt + F1`: a key to press or a key combination; keys are shown in uppercase as on a keyboard
- *File, File > Save As*: menu items, buttons

- ▶ **amd64 em64t ipf:** This paragraph is only relevant for the specified architectures. The arrows mark the beginning and the end of the text block. ◀
 - ▶ **ipseries zseries:** This paragraph is only relevant for the specified architectures. The arrows mark the beginning and the end of the text block. ◀
- *Dancing Penguins* (Chapter *Penguins*, ↑Another Manual): This is a reference to a chapter in another manual.

Security and Confidentiality

One of the main characteristics of a Linux or UNIX system is its ability to handle several users at the same time (multiuser) and to allow these users to perform several tasks (multitasking) on the same computer simultaneously. Moreover, the operating system is network transparent. The users often do not know whether the data and applications they are using are provided locally from their machine or made available over the network.

With the multiuser capability, the data of different users must be stored separately, and security and privacy need to be guaranteed. Data security was already an important issue, even before computers could be linked through networks. Just like today, the most important concern was the ability to keep data available in spite of a lost or otherwise damaged data medium (a hard disk in most cases).

This section is primarily focused on confidentiality issues and on ways to protect the privacy of users, but it cannot be stressed enough that a comprehensive security concept should always include procedures to have a regularly updated, workable, and tested backup in place. Without this, you could have a very hard time getting your data back—not only in the case of some hardware defect, but also in the case that someone has gained unauthorized access and tampered with files.

1.1 Local Security and Network Security

There are several ways of accessing data:

- personal communication with people who have the desired information or access to the data on a computer
- directly through physical access from the console of a computer
- over a serial line
- using a network link

In all these cases, a user should be authenticated before accessing the resources or data in question. A Web server might be less restrictive in this respect, but you still would not want it to disclose your personal data to an anonymous user.

In the list above, the first case is the one where the highest amount of human interaction is involved (such as when you are contacting a bank employee and are required to prove that you are the person owning that bank account). Then, you are asked to provide a signature, a PIN, or a password to prove that you are the person you claim to be. In some cases, it might be possible to elicit some intelligence from an informed person just by mentioning known bits and pieces to win the confidence of that person. The victim could be led to reveal gradually more information, maybe without even being aware of it. Among hackers, this is called *social engineering*. You can only guard against this by educating people and by dealing with language and information in a conscious way. Before breaking into computer systems, attackers often try to target receptionists, service people working with the company, or even family members. In many cases, such an attack based on social engineering is only discovered at a much later time.

A person wanting to obtain unauthorized access to your data could also use the traditional way and try to get at your hardware directly. Therefore, the machine should be protected against any tampering so that no one can remove, replace, or cripple its components. This also applies to backups and even any network cables or power cords. Also secure the boot procedure, because there are some well-known key combinations that might provoke unusual behavior. Protect yourself against this by setting passwords for the BIOS and the boot loader.

Serial terminals connected to serial ports are still used in many places. Unlike network interfaces, they do not rely on network protocols to communicate with the host. A simple cable or an infrared port is used to send plain characters back and forth between the devices. The cable itself is the weakest point of such a system: with an older printer connected to it, it is easy to record any data being transferred thusly. What can be achieved with a printer can also be accomplished in other ways, depending on the effort that goes into the attack.

Reading a file locally on a host requires additional access rules than opening a network connection with a server on a different host. There is a distinction between local security and network security. The line is drawn where data must be put into packets to be sent somewhere else.

1.1.1 Local Security

Local security starts with the physical environment at the location in which computer is running. Set up your machine in a place where security is in line with your expectations and needs. The main goal of local security is to keep users separate from each other, so no user can assume the permissions or the identity of another. This is a general rule to be observed, but it is especially true for the user `root`, who holds system administration privileges. `root` can take on the identity of any other local user and read any locally-stored file without being prompted for the password.

Passwords

On a Linux system, passwords are not stored as plain text and the entered text string is not simply matched with the saved pattern. If this were the case, all accounts on your system would be compromised as soon as someone got access to the corresponding file. Instead, the stored password is encrypted and, each time it is entered, is encrypted again and the two encrypted strings are compared. This only provides more security if the encrypted password cannot be reverse-computed into the original text string.

This is actually achieved by a special kind of algorithm, also called *trapdoor algorithm*, because it only works in one direction. An attacker who has obtained the encrypted string is not able to get your password by simply applying the same algorithm again. Instead, it would be necessary to test all the possible character combinations until a combination is found that looks like your password when encrypted. With passwords eight characters long, there are quite a number of possible combinations to calculate.

In the seventies, it was argued that this method would be more secure than others due to the relative slowness of the algorithm used, which took a few seconds to encrypt just one password. In the meantime, however, PCs have become powerful enough to do several hundred thousand or even millions of encryptions per second. Because of this, encrypted passwords should not be visible to regular users (`/etc/shadow` cannot be read by normal users). It is even more important that passwords are not easy to guess, in case the password file becomes visible due to some error. Consequently, it is not really useful to “translate” a password like “tantalize” into “t@nt@1lz3”.

Replacing some letters of a word with similar looking numbers (like writing the password “tantalize” as “t@nt@1lz3”) is not sufficient. Password cracking programs that use dictionaries to guess words also play with substitutions like that. A better way is to make up a word with no common meaning, something that only makes sense to you personally, like the first letters of the words of a sentence or the title of a book, such as “The Name of the Rose” by Umberto Eco. This would give the following safe password: “TNotRbUE9”. In contrast, passwords like “beerbuddy” or “jasmine76” are easily guessed even by someone who has only some casual knowledge about you.

The Boot Procedure

Configure your system so it cannot be booted from a floppy or from a CD, either by removing the drives entirely or by setting a BIOS password and configuring the BIOS to allow booting from a hard disk only. Normally, a Linux system is started by a boot loader, allowing you to pass additional options to the booted kernel. Prevent others from using such parameters during boot by setting an additional password in `/boot/grub/menu.lst` (see Chapter 8, *The Boot Loader GRUB (Administration Guide)*). This is crucial to your system's security. Not only does the kernel itself run with `root` permissions, but it is also the first authority to grant `root` permissions at system start-up.

File Permissions

As a general rule, always work with the most restrictive privileges possible for a given task. For example, it is definitely not necessary to be `root` to read or write e-mail. If the mail program has a bug, this bug could be exploited for an attack that acts with exactly the permissions of the program when it was started. By following the above rule, minimize the possible damage.

The permissions of all files included in the SUSE Linux Enterprise Server distribution are carefully chosen. A system administrator who installs additional software or other files should take great care when doing so, especially when setting the permission bits. Experienced and security-conscious system administrators always use the `-l` option with the command `ls` to get an extensive file list, which allows them to detect any incorrect file permissions immediately. An incorrect file attribute does not only mean that files could be changed or deleted. These modified files could be executed by `root` or, in the case of configuration files, programs could use such files with the permissions of `root`. This significantly increases the possibilities of an attack. Attacks like these are called cuckoo eggs, because the program (the egg) is executed (hatched) by a different user (bird), just like a cuckoo tricks other birds into hatching its eggs.

An SUSE® Linux Enterprise Server system includes the files `permissions`, `permissions.easy`, `permissions.secure`, and `permissions.paranoid`, all in the directory `/etc`. The purpose of these files is to define special permissions, such as world-writable directories or, for files, the setuser ID bit (programs with the setuser ID bit set do not run with the permissions of the user that has launched it, but with the permissions of the file owner, in most cases `root`). An administrator can use the file `/etc/permissions.local` to add his own settings.

To define which of the above files is used by SUSE Linux Enterprise Server's configuration programs to set permissions, select *Local Security* in the *Security and Users* section of YaST. To learn more about the topic, read the comments in `/etc/permissions` or consult the manual page of `chmod` (`man chmod`).

Buffer Overflows and Format String Bugs

Special care must be taken whenever a program needs to process data that could be changed by a user, but this is more of an issue for the programmer of an application than for regular users. The programmer must make sure that his application interprets data in the correct way, without writing it into memory areas that are too small to hold it. Also, the program should hand over data in a consistent manner, using interfaces defined for that purpose.

A *buffer overflow* can happen if the actual size of a memory buffer is not taken into account when writing to that buffer. There are cases where this data (as generated by the user) uses up more space than what is available in the buffer. As a result, data is written beyond the end of that buffer area, which, under certain circumstances, makes it possible for a program to execute program sequences influenced by the user (and not

by the programmer), rather than just processing user data. A bug of this kind may have serious consequences, especially if the program is being executed with special privileges (see Section “File Permissions” (page 4)).

Format string bugs work in a slightly different way, but again it is the user input that could lead the program astray. In most cases, these programming errors are exploited with programs executed with special permissions—`setuid` and `setgid` programs—which also means that you can protect your data and your system from such bugs by removing the corresponding execution privileges from programs. Again, the best way is to apply a policy of using the lowest possible privileges (see Section “File Permissions” (page 4)).

Given that buffer overflows and format string bugs are bugs related to the handling of user data, they are not only exploitable if access has been given to a local account. Many of the bugs that have been reported can also be exploited over a network link. Accordingly, buffer overflows and format string bugs should be classified as being relevant for both local and network security.

Viruses

Contrary to popular opinion, there are viruses that run on Linux. However, the viruses that are known were released by their authors as a *proof of concept* that the technique works as intended. None of these viruses have been spotted *in the wild* so far.

Viruses cannot survive and spread without a host on which to live. In this case, the host would be a program or an important storage area of the system, such as the master boot record, which needs to be writable for the program code of the virus. Owing to its multiuser capability, Linux can restrict write access to certain files (this is especially important with system files). Therefore, if you did your normal work with `root` permissions, you would increase the chance of the system being infected by a virus. In contrast, if you follow the principle of using the lowest possible privileges as mentioned above, chances of getting a virus are slim.

Apart from that, you should never rush into executing a program from some Internet site that you do not really know. SUSE Linux Enterprise Server's RPM packages carry a cryptographic signature, as a digital label that the necessary care was taken to build them. Viruses are a typical sign that the administrator or the user lacks the required security awareness, putting at risk even a system that should be highly secure by its very design.

Viruses should not be confused with worms, which belong entirely to the world of networks. Worms do not need a host to spread.

1.1.2 Network Security

Network security is important for protecting from an attack that is started outside the network. The typical login procedure requiring a username and a password for user authentication is still a local security issue. In the particular case of logging in over a network, differentiate between the two security aspects. What happens until the actual authentication is network security and anything that happens afterwards is local security.

X Window System and X Authentication

As mentioned at the beginning, network transparency is one of the central characteristics of a UNIX system. X, the windowing system of UNIX operating systems, can make use of this feature in an impressive way. With X, it is basically no problem to log in at a remote host and start a graphical program that is then sent over the network to be displayed on your computer.

When an X client needs to be displayed remotely using an X server, the latter should protect the resource managed by it (the display) from unauthorized access. In more concrete terms, certain permissions must be given to the client program. With the X Window System, there are two ways to do this, called host-based access control and cookie-based access control. The former relies on the IP address of the host where the client should run. The program to control this is `xhost`. `xhost` enters the IP address of a legitimate client into a database belonging to the X server. However, relying on IP addresses for authentication is not very secure. For example, if there were a second user working on the host sending the client program, that user would have access to the X server as well—just like someone stealing the IP address. Because of these shortcomings, this authentication method is not described in more detail here, but you can learn about it with `man xhost`.

In the case of cookie-based access control, a character string is generated that is only known to the X server and to the legitimate user, just like an ID card of some kind. This cookie is stored on login in the file `.Xauthority` in the user's home directory and is available to any X client wanting to use the X server to display a window. The file `.Xauthority` can be examined by the user with the tool `xauth`. If you rename

.Xauthority, or if you delete the file from your home directory by accident, you would not be able to open any new windows or X clients.

SSH (secure shell) can be used to encrypt a network connection completely and forward it to an X server transparently, without the encryption mechanism being perceived by the user. This is also called X forwarding. X forwarding is achieved by simulating an X server on the server side and setting a DISPLAY variable for the shell on the remote host. Further details about SSH can be found in Chapter 14, *SSH: Secure Network Operations* (page 167).

WARNING

If you do not consider the host where you log in to be a secure host, do not use X forwarding. With X forwarding enabled, an attacker could authenticate via your SSH connection to intrude on your X server and perpetrate various actions (reading, or sniffing, your keyboard input, for instance).

Buffer Overflows and Format String Bugs

As discussed in Section “Buffer Overflows and Format String Bugs” (page 5), buffer overflows and format string bugs should be classified as issues applying to both local and network security. As with the local variants of such bugs, buffer overflows in network programs, when successfully exploited, are mostly used to obtain `root` permissions. Even if that is not the case, an attacker could use the bug to gain access to an unprivileged local account to exploit other vulnerabilities that might exist on the system.

Buffer overflows and format string bugs exploitable over a network link are certainly the most frequent form of remote attacks, in general. Exploits for these—programs to exploit these newly-found security holes—are often posted on security mailing lists. They can be used to target the vulnerability without knowing the details of the code. Over the years, experience has shown that the availability of exploit codes has contributed to more secure operating systems, obviously due to the fact that operating system makers were forced to fix the problems in their software. With free software, anyone has access to the source code (SUSE Linux Enterprise Server comes with all available source codes) and anyone who finds a vulnerability and its exploit code can submit a patch to fix the corresponding bug.

Denial of Service

The purpose of a denial of service (DoS) attack is to block a server program or even an entire system, something that could be achieved by various means: overloading the server, keeping it busy with garbage packets, or exploiting a remote buffer overflow. Often, a DoS attack is made with the sole purpose of making the service disappear. However, once a given service has become unavailable, communications could become vulnerable to *man-in-the-middle attacks* (sniffing, TCP connection hijacking, spoofing) and DNS poisoning.

Man in the Middle: Sniffing, Hijacking, Spoofing

In general, any remote attack performed by an attacker who puts himself between the communicating hosts is called a *man-in-the-middle attack*. What almost all types of man-in-the-middle attacks have in common is that the victim is usually not aware that there is something happening. There are many possible variants. For example, the attacker could pick up a connection request and forward that to the target machine. Now the victim has unwittingly established a connection with the wrong host, because the other end is posing as the legitimate destination machine.

The simplest form of a man-in-the-middle attack is called *sniffer* (the attacker is “just” listening to the network traffic passing by). As a more complex attack, the “man in the middle” could try to take over an already established connection (hijacking). To do so, the attacker would need to analyze the packets for some time to be able to predict the TCP sequence numbers belonging to the connection. When the attacker finally seizes the role of the target host, the victims notice this, because they get an error message saying the connection was terminated due to a failure. The fact that there are protocols not secured against hijacking through encryption (which only perform a simple authentication procedure upon establishing the connection) makes it easier for attackers.

Spoofing is an attack where packets are modified to contain counterfeit source data, usually the IP address. Most active forms of attack rely on sending out such fake packets (something that, on a Linux machine, can only be done by the superuser (`root`)).

Many of the attacks mentioned are carried out in combination with a DoS. If an attacker sees an opportunity to bring down a certain host abruptly, even if only for a short time, it makes it easier for him to push the active attack, because the host will not be able to interfere with the attack for some time.

DNS Poisoning

DNS poisoning means that the attacker corrupts the cache of a DNS server by replying to it with spoofed DNS reply packets, trying to get the server to send certain data to a victim who is requesting information from that server. Many servers maintain a trust relationship with other hosts, based on IP addresses or hostnames. The attacker needs a good understanding of the actual structure of the trust relationships among hosts to disguise itself as one of the trusted hosts. Usually, the attacker analyzes some packets received from the server to get the necessary information. The attacker often needs to target a well-timed DoS attack at the name server as well. Protect yourself by using encrypted connections that are able to verify the identity of the hosts to which to connect.

Worms

Worms are often confused with viruses, but there is a clear difference between the two. Unlike viruses, worms do not need to infect a host program to live. Instead, they are specialized to spread as quickly as possible on network structures. The worms that appeared in the past, such as Ramen, Lion, or Adore, make use of well-known security holes in server programs like bind8 or lprNG. Protection against worms is relatively easy. Given that some time elapses between the discovery of a security hole and the moment the worm hits your server, there is a good chance that an updated version of the affected program is available on time. That is only useful if the administrator actually installs the security updates on the systems in question.

1.2 Some General Security Tips and Tricks

To handle security competently, it is important to observe some recommendations. You may find the following list of rules useful in dealing with basic security concerns:

- Get and install the updated packages recommended by security announcements as quickly as possible.
- Stay informed about the latest security issues:
 - opensuse-security-announce@opensuse.org is the SUSE mailinglist for security announcements. It is a first-hand source of information regarding

updated packages and includes members of SUSE's security team among its active contributors. You can subscribe to this list on page <http://en.opensuse.org/Communicate/Mailinglists>.

- Find SUSE security advisories as a news feed at http://www.novell.com/linux/security/suse_security.xml.
- bugtraq@securityfocus.com is one of the best-known security mailing lists worldwide. Reading this list, which receives between 15 and 20 postings per day, is recommended. More information can be found at <http://www.securityfocus.com>.
- Discuss any security issues of interest on our mailinglist opensuse-security@opensuse.org.
- According to the rule of using the most restrictive set of permissions possible for every job, avoid doing your regular jobs as `root`. This reduces the risk of getting a cuckoo egg or a virus and protects you from your own mistakes.
- If possible, always try to use encrypted connections to work on a remote machine. Using `ssh` (secure shell) to replace `telnet`, `ftp`, `rsh`, and `rlogin` should be standard practice.
- Avoid using authentication methods based solely on IP addresses.
- Try to keep the most important network-related packages up-to-date and subscribe to the corresponding mailing lists to receive announcements on new versions of such programs (`bind`, `postfix`, `ssh`, etc.). The same should apply to software relevant to local security.
- Change the `/etc/permissions` file to optimize the permissions of files crucial to your system's security. If you remove the `setuid` bit from a program, it might well be that it cannot do its job anymore in the intended way. On the other hand, consider that, in most cases, the program will also have ceased to be a potential security risk. You might take a similar approach with world-writable directories and files.
- Disable any network services you do not absolutely require for your server to work properly. This makes your system safer. Open ports, with the socket state `LISTEN`, can be found with the program `netstat`. As for the options, it is recommended

to use `netstat -ap` or `netstat -anp`. The `-p` option allows you to see which process is occupying a port under which name.

Compare the `netstat` results with those of a thorough port scan done from outside your host. An excellent program for this job is `nmap`, which not only checks out the ports of your machine, but also draws some conclusions as to which services are waiting behind them. However, port scanning may be interpreted as an aggressive act, so do not do this on a host without the explicit approval of the administrator. Finally, remember that it is important not only to scan TCP ports, but also UDP ports (options `-sS` and `-sU`).

- To monitor the integrity of the files of your system in a reliable way, use the program `AIDE` (Advanced Intrusion Detection Environment), available on SUSE Linux Enterprise Server. Encrypt the database created by `AIDE` to prevent someone from tampering with it. Furthermore, keep a backup of this database available outside your machine, stored on an external data medium not connected to it by a network link.
- Take proper care when installing any third-party software. There have been cases where a hacker had built a trojan horse into the tar archive of a security software package, which was fortunately discovered very quickly. If you install a binary package, have no doubts about the site from which you downloaded it.

SUSE's RPM packages are `gpg`-signed. The key used by SUSE for signing is:

```
ID:9C800ACA 2000-10-19 SUSE Package Signing Key <build@suse.de>  
Key fingerprint = 79C1 79B2 E1C8 20C1 890F 9994 A84E DAE8 9C80 0ACA
```

The command `rpm --checksig package.rpm` shows whether the checksum and the signature of an uninstalled package are correct. Find the key on the first CD of the distribution and on most key servers worldwide.

- Check backups of user and system files regularly. Consider that if you do not test whether the backup works, it might actually be worthless.
- Check your log files. Whenever possible, write a small script to search for suspicious entries. Admittedly, this is not exactly a trivial task. In the end, only you can know which entries are unusual and which are not.
- Use `tcp_wrapper` to restrict access to the individual services running on your machine, so you have explicit control over which IP addresses can connect to a

service. For further information regarding `tcp_wrapper`, consult the manual pages of `tcpd` and `hosts_access` (`man 8 tcpd`, `man hosts_access`).

- Use `SuSEfirewall` to enhance the security provided by `tcpd` (`tcp_wrapper`).
- Design your security measures to be redundant: a message seen twice is much better than no message at all.
- If you use `suspend` to disk, consider configuring the suspend image encryption using the `configure-suspend-encryption.sh` script. The program creates the key, copies it to `/etc/suspend.key`, and modifies `/etc/suspend.conf` to use encryption for suspend images.

1.3 Using the Central Security Reporting Address

If you discover a security-related problem (please check the available update packages first), write an e-mail to security@suse.de. Please include a detailed description of the problem and the version number of the package concerned. SUSE will try to send a reply as soon as possible. You are encouraged to pgp-encrypt your e-mail messages. SUSE's pgp key is:

```
ID:3D25D3D9 1999-03-06 SUSE Security Team <security@suse.de>  
Key fingerprint = 73 5F 2E 99 DF DB 94 C4 8F 5A A3 AE AF 22 F2 D5
```

This key is also available for download from <http://www.novell.com/linux/security/securitysupport.html>.

Part I. Authentication

Authentication with PAM

Linux uses PAM (pluggable authentication modules) in the authentication process as a layer that mediates between user and application. PAM modules are available on a systemwide basis, so they can be requested by any application. This chapter describes how the modular authentication mechanism works and how it is configured.

2.1 What is PAM?

System administrators and programmers often want to restrict access to certain parts of the system or to limit the use of certain functions of an application. Without PAM, applications must be adapted every time a new authentication mechanism, such as LDAP, Samba, or Kerberos, is introduced. This process, however, is rather time-consuming and error-prone. One way to avoid these drawbacks is to separate applications from the authentication mechanism and delegate authentication to centrally managed modules. Whenever a newly required authentication scheme is needed, it is sufficient to adapt or write a suitable *PAM module* for use by the program in question.

The PAM concept consists of:

- *PAM modules* are a set of shared libraries for a specific authentication mechanism.
- A *module stack* consists of one or more PAM modules.
- A PAM-aware *service* which needs authentication by using a module stack or PAM modules. Usually a service is a familiar name of the corresponding application, like `login` or `su`. The service name `other` is a reserved word for default rules.

- The execution of a single PAM module can be influenced by *module arguments*.
- Each *result* of a single PAM module execution is evaluated. A positive value executes the next PAM module, a negative value depends on the configuration how to proceed. You can configure it as “no influence, proceed” to “terminate immediately” and anything in between.

2.2 Structure of a PAM Configuration File

PAM can be configured in two ways:

File based configuration (`/etc/pam.conf`)

The configuration of each service is stored in `/etc/pam.conf`. However, for maintenance and usability reasons, this configuration scheme is not used in SUSE Linux Enterprise Server.

Directory based configuration (`/etc/pam.d/`)

Every service (or program) that relies on the PAM mechanism has its own configuration file in the `/etc/pam.d/` directory. For example, the service for `sshd` can be found in the `/etc/pam.d/sshd` file.

The files under `/etc/pam.d/` define the PAM modules used for authentication. Each file consists of lines, which define a service, and each line consists of a maximum of four components:

```
TYPE CONTROL MODULE_PATH MODULE_ARGS
```

The components have the following meaning:

TYPE

Declares the type of the service. PAM modules are processed as stacks. Different types of modules have different purposes. For example, one module checks the password, another verifies the location from which the system is accessed, and yet another reads user-specific settings. PAM knows about four different types of modules:

auth

Check the user's authenticity, traditionally by quering a password. However, this can also be achieved with the help of a chip card or through biometrics (for example, fingerprints or iris scan).

account

Modules of this type check if the user has general permission to use the requested service. As an example, such a check should be performed to ensure that no one can log in with the username of an expired account.

password

The purpose of this type of module is to enable the change of an authentication token. In most cases, this is a password.

session

Modules of this type are responsible for managing and configuring user sessions. They are started before and after authentication to log login attempts and configure the user's specific environment (mail accounts, home directory, system limits, etc.).

CONTROL

Indicates the behaviour of a PAM module. Each module can have the following control flags:

required

A module with this flag must be successfully processed before the authentication may proceed. After the failure of a module with the `required` flag, all other modules with the same flag are processed before the user receives a message about the failure of the authentication attempt.

requisite

Modules having this flag must also be processed successfully, in much the same way as a module with the `required` flag. However, in case of failure a module with this flag gives immediate feedback to the user and no further modules are processed. In case of success, other modules are subsequently processed, just like any modules with the `required` flag. The `requisite` flag can be used as a basic filter checking for the existence of certain conditions that are essential for a correct authentication.

sufficient

After a module with this flag has been successfully processed, the requesting application receives an immediate message about the success and no further modules are processed, provided there was no preceding failure of a module with the `required` flag. The failure of a module with the `sufficient` flag has no direct consequences, in the sense that any subsequent modules are processed in their respective order.

optional

The failure or success of a module with this flag does not have any direct consequences. This can be useful for modules that are only intended to display a message (for example, to tell the user that mail has arrived) without taking any further action.

include

If this flag is given, the file specified as argument is inserted at this place.

MODULE_PATH

Contains a full filename of a PAM module. It does not need to be specified explicitly, as long as the module is located in the default directory `/lib/security` (for all 64-bit platforms supported by SUSE® Linux Enterprise Server, the directory is `/lib64/security`).

MODULE_ARGS

Contains a space-separated list of options to influence the behaviour of a PAM module, such as `debug` (enables debugging) or `nullok` (allows the use of empty passwords).

In addition, there are global configuration files for PAM modules under `/etc/security`, which define the exact behavior of these modules (examples include `pam_env.conf` and `time.conf`). Every application that uses a PAM module actually calls a set of PAM functions, which then process the information in the various configuration files and return the result to the requesting application.

To facilitate the creation and maintenance of PAM modules, common default configuration files for the types `auth`, `account`, `password`, and `session` modules have been introduced. These are retrieved from every application's PAM configuration. Updates to the global PAM configuration modules in `common-*` are thus propagated

across all PAM configuration files without requiring the administrator to update every single PAM configuration file.

The global common PAM configuration files are maintained using the `pam-config` tool. This tool automatically adds new modules to the configuration, changes the configuration of existing ones or deletes modules (or options) from the configurations. Manual intervention in maintaining PAM configurations is minimized or no longer required.

NOTE: 64-Bit and 32-Bit Mixed Installations

When using a 64-bit operating system, it is possible to also include a runtime environment for 32-bit applications. In this case, make sure that you install both versions of the respective pam modules when installing new modules.

2.3 The PAM Configuration of sshd

Consider the PAM configuration of `sshd` as an example:

Example 2.1 *PAM Configuration for sshd (/etc/pam.d/sshd)*

```
##PAM-1.0 ❶
auth    required    pam_nologin.so ❷
auth    include     common-auth ❸
account include     common-account ❸
password include    common-password ❸
session required    pam_loginuid.so ❹
session include     common-session ❸
```

- ❶ Declares the version of this configuration file for PAM 1.0. This is merely a convention, but could be used in the future to check the version.
- ❷ Checks, if `/etc/nologin` exists. If it does, no user other than `root` may log in.
- ❸ Refers to the configuration files of four module types: `common-auth`, `common-account`, `common-password`, and `common-session`. These four files hold the default configuration for each module type.
- ❹ Sets the login uid process attribute for the process that was authenticated.

By including them instead of adding each module separately to the respective PAM configuration, you automatically get an updated PAM configuration when an administrator changes the defaults. Formerly, you had to adjust all configuration files manually for all applications when changes to PAM occurred or a new application was installed. Now the PAM configuration is made with central configuration files and all changes are automatically inherited by the PAM configuration of each service.

The first include file (`common-auth`) calls three modules of the `auth` type: `pam_env.so`, `pam_gnome_keyring.so` and `pam_unix2.so`. See Example 2.2, “Default Configuration for the `auth` Section” (page 22).

Example 2.2 *Default Configuration for the `auth` Section*

```
auth    required    pam_env.so
auth    optional    pam_gnome_keyring.so
auth    required    pam_unix2.so
```

The first one, `pam_env.so`, loads `/etc/security/pam_env.conf` to set the environment variables as specified in this file. It can be used to set the `DISPLAY` variable to the correct value, because the `pam_env` module knows about the location from which the login is taking place. The second one automatically unlocks the GNOME keyring when necessary. The last one, `pam_unix2`, checks the user's login and password against `/etc/passwd` and `/etc/shadow`.

The whole stack of `auth` modules is processed before `sshd` gets any feedback about whether the login has succeeded. Given that all modules of the stack have the `required` control flag, they must all be processed successfully before `sshd` receives a message about the positive result. If one of the modules is not successful, the entire module stack is still processed and only then is `sshd` notified about the negative result.

As soon as all modules of the `auth` type have been successfully processed, another include statement is processed, in this case, that in Example 2.3, “Default Configuration for the `account` Section” (page 22). `common-account` contains just one module, `pam_unix2`. If `pam_unix2` returns the result that the user exists, `sshd` receives a message announcing this success and the next stack of modules (`password`) is processed, shown in Example 2.4, “Default Configuration for the `password` Section” (page 23).

Example 2.3 *Default Configuration for the `account` Section*

```
account required    pam_unix2.so
```

Example 2.4 *Default Configuration for the password Section*

```
password requisite      pam_pwcheck.so  nullok cracklib
password required      pam_unix2.so    nullok use_auth tok
```

Again, the PAM configuration of `sshd` involves just an include statement referring to the default configuration for `password` modules located in `common-password`. These modules must successfully be completed (control flags `requisite` and `required`) whenever the application requests the change of an authentication token.

Changing a password or another authentication token requires a security check. This is achieved with the `pam_pwcheck` module. The `pam_unix2` module used afterwards carries over any old and new passwords from `pam_pwcheck`, so the user does not need to authenticate again after changing the password. This procedure makes it impossible to circumvent the checks carried out by `pam_pwcheck`. Whenever the account or the `auth` type are configured to complain about expired passwords, the `password` modules should also be used.

Example 2.5 *Default Configuration for the session Section*

```
session required      pam_limits.so
session required      pam_unix2.so
session optional      pam_umask.so
```

As the final step, the modules of the `session` type (bundled in the `common-session` file) are called to configure the session according to the settings for the user in question. The `pam_limits` module loads the file `/etc/security/limits.conf`, which may define limits on the use of certain system resources. The `pam_unix2` module is processed again. The `pam_umask` module can be used to set the file mode creation mask. Since this module carries the `optional` flag, a failure of this module would not affect the successful completion of the entire session module stack. The `session` modules are called a second time when the user logs out.

2.4 Configuration of PAM Modules

Some of the PAM modules are configurable. The configuration files are located in `/etc/security`. This section briefly describes the configuration files relevant to the `sshd` example—`pam_env.conf` and `limits.conf`.

2.4.1 pam_env.conf

`pam_env.conf` can be used to define a standardized environment for users that is set whenever the `pam_env` module is called. With it, preset environment variables using the following syntax:

```
VARIABLE [DEFAULT=value] [OVERRIDE=value]
```

VARIABLE

Name of the environment variable to set.

```
[DEFAULT=<value>]
```

Default *value* the administrator wants to set.

```
[OVERRIDE=<value>]
```

Values that may be queried and set by `pam_env`, overriding the default value.

A typical example of how `pam_env` can be used is the adaptation of the `DISPLAY` variable, which is changed whenever a remote login takes place. This is shown in Example 2.6, “`pam_env.conf`” (page 24).

Example 2.6 *pam_env.conf*

```
REMOTEHOST      DEFAULT=localhost OVERRIDE=@{PAM_RHOST}  
DISPLAY         DEFAULT=${REMOTEHOST}:0.0 OVERRIDE=${DISPLAY}
```

The first line sets the value of the `REMOTEHOST` variable to `localhost`, which is used whenever `pam_env` cannot determine any other value. The `DISPLAY` variable in turn contains the value of `REMOTEHOST`. Find more information in the comments in `/etc/security/pam_env.conf`.

2.4.2 pam_mount.conf

The purpose of `pam_mount` is to mount user home directories during the login process, and to unmount them during logout in an environment where a central file server keeps all the home directories of users. With this method, it is not necessary to mount a complete `/home` directory where all the user home directories would be accessible. Instead, only the home directory of the user who is about to log in, is mounted.

After installing `pam_mount`, a template of `pam_mount.conf.xml` is available in `/etc/security`. The description of the various elements can be found in the manual page `man 5 pam_mount.conf`.

A basic configuration of this feature can be done with YaST. Select *Network Settings* > *Windows Domain Membership* > *Expert Settings* to add the file server.

2.4.3 limits.conf

System limits can be set on a user or group basis in `limits.conf`, which is read by the `pam_limits` module. The file allows you to set hard limits, which may not be exceeded at all, and soft limits, which may be exceeded temporarily. For more information about the syntax and the options, see the comments in `/etc/security/limits.conf`.

2.5 Configuring PAM Using pam-config

The `pam-config` tool helps you configure the global PAM configuration files (`/etc/pam.d/common-*pc`) as well as several selected application configurations. For a list of supported modules, use the `pam-config --list-modules` command. Use the `pam-config` command to maintain your PAM configuration files. Add new modules to your PAM configurations, delete other modules or modify options to these modules. When changing global PAM configuration files, no manual tweaking of the PAM setup for individual applications is required.

A simple use case for `pam-config` involve the following:

- 1 Auto-generate a fresh Unix-style PAM configuration.** Let `pam-config` create the simplest possible setup which you can extend later on. The `pam-config --create` command creates a simple UNIX authentication configuration. Pre-existing configuration files not maintained by `pam-config` are overwritten, but backup copies are kept as `*.pam-config-backup`.

- 2 Add a new authentication method.** Adding a new authentication method (for example, LDAP) to your stack of PAM modules comes down to a simple `pam-config --add --ldap` command. LDAP is added wherever appropriate across all `common-*-pc` PAM configuration files.
- 3 Add debugging for test purposes.** To make sure the new authentication procedure works as planned, turn on debugging for all PAM-related operations. The `pam-config --add --ldap-debug` turns on debugging for LDAP-related PAM operations. Find the debugging output in `/var/log/messages`.
- 4 Query your setup.** Before you finally apply your new PAM setup, check if it contains all the options you wanted to add. The `pam-config --query --module` lists both the type and the options for the queried PAM module.
- 5 Remove the debug options.** Finally, remove the debug option from your setup when you are entirely satisfied with the performance of it. The `pam-config --delete --ldap-debug` command turns off debugging for LDAP authentication. In case you had debugging options added for other modules, use similar commands to turn these off.

When you create your PAM configuration files from scratch using the `pam-config --create` command, it creates symbolic links from the `common-*` to the `common-*-pc` files. `pam-config` only modifies the `common-*-pc` configuration files. Removing these symbolic links effectively disables `pam-config`, because `pam-config` only operates on the `common-*-pc` files and these files are not put into effect without the symbolic links.

For more information on the `pam-config` command and the options available, refer to the manual page of `pam-config(8)`.

2.6 For More Information

In the `/usr/share/doc/packages/pam` directory of the installed system, find the following additional documentation:

READMEs

In the top level of this directory, there is the general README file. The subdirectory `modules` holds README files about the available PAM modules.

The Linux-PAM System Administrators' Guide

This document comprises everything that the system administrator should know about PAM. It discusses a range of topics, from the syntax of configuration files to the security aspects of PAM.

The Linux-PAM Module Writers' Manual

This document summarizes the topic from the developer's point of view, with information about how to write standard-compliant PAM modules.

The Linux-PAM Application Developers' Guide

This document comprises everything needed by an application developer who wants to use the PAM libraries.

The PAM Manual Pages

PAM in general as well as the individual modules come with manual pages that provide a good overview of the functionality provided by the respective component.

Thorsten Kukuk has developed a number of PAM modules. Find the documentation of these modules at <http://www.suse.de/~kukuk/pam/>.

Using NIS

As soon as multiple UNIX systems in a network want to access common resources, it becomes imperative that all user and group identities are the same for all machines in that network. The network should be transparent to users: their environments should not vary, regardless of which machine they are actually using. This can be done by means of NIS and NFS services. NFS distributes file systems over a network and is discussed in Chapter 25, *Sharing File Systems with NFS* (↑*Administration Guide*).

NIS (Network Information Service) can be described as a database-like service that provides access to the contents of `/etc/passwd`, `/etc/shadow`, and `/etc/group` across networks. NIS can also be used for other purposes (making the contents of files like `/etc/hosts` or `/etc/services` available, for example), but this is beyond the scope of this introduction. People often refer to NIS as *YP*, because it works like the network's “yellow pages.”

3.1 Configuring NIS Servers

To distribute NIS information across networks, you can either have one single server (a *master*) that serves all clients, or you can have NIS slave servers requesting this information from the master and relaying it to their respective clients.

- To configure just one NIS server for your network, proceed with Section 3.1.1, “Configuring a NIS Master Server” (page 30).
- If your NIS master server needs to export its data to slave servers, set up the master server as described in Section 3.1.1, “Configuring a NIS Master Server” (page 30)

and set up slave servers in the subnets as described in Section 3.1.2, “Configuring a NIS Slave Server” (page 34).

3.1.1 Configuring a NIS Master Server

To configure a NIS master server for your network, proceed as follows:

- 1 Start *YaST* > *Network Services* > *NIS Server*.
- 2 If you need just one NIS server in your network or if this server is to act as the master for further NIS slave servers, select *Install and Set Up NIS Master Server*. YaST installs the required packages.

TIP

If NIS server software is already installed on your machine, initiate the creation of a NIS master server by clicking *Create NIS Master Server*.

Figure 3.1 *NIS Server Setup*

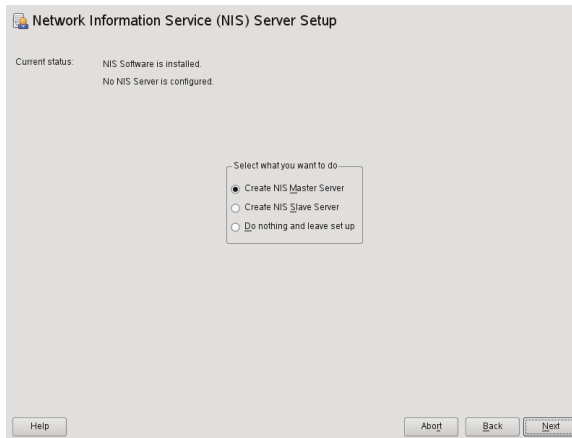

- 3 Determine basic NIS setup options:

3a Enter the NIS domain name.

- 3b** Define whether the host should also be a NIS client (enabling users to log in and access data from the NIS server) by selecting *This Host is also a NIS Client*.
- 3c** If your NIS server needs to act as a master server to NIS slave servers in other subnets, select *Active Slave NIS Server Exists*.

The option *Fast Map Distribution* is only useful in conjunction with *Active Slave NIS Servers Exist*. It speeds up the transfer of maps to the slaves.

- 3d** Select *Allow Changes to Passwords* to allow users in your network (both local users and those managed through the NIS server) to change their passwords on the NIS server (with the command `yppasswd`). This makes the options *Allow Changes to GECOS Field* and *Allow Changes to Login Shell* available. “GECOS” means that the users can also change their names and address settings with the command `ypchfn`. “Shell” allows users to change their default shell with the command `ypchsh` (for example, to switch from `bash` to `sh`). The new shell must be one of the predefined entries in `/etc/shells`.
- 3e** Select *Open Port in Firewall* to have YaST adapt the firewall settings for the NIS server.

Figure 3.2 *Master Server Setup*

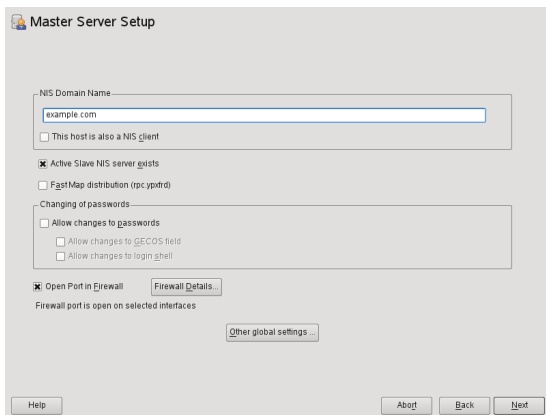

- 3f Leave this dialog with *Next* or click *Other Global Settings* to make additional settings.

Other Global Settings include changing the source directory of the NIS server (`/etc` by default). In addition, passwords can be merged here. The setting should be *Yes* to create the user database from the system authentication files `/etc/passwd`, `/etc/shadow`, and `/etc/group`. Also, determine the smallest user and group ID that should be offered by NIS. Click *OK* to confirm your settings and return to the previous screen.

Figure 3.3 *Changing the Directory and Synchronizing Files for a NIS Server*

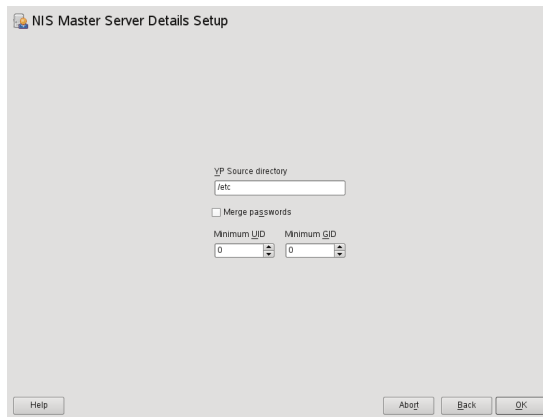

- 4 If you previously enabled *Active Slave NIS Server Exists*, enter the hostnames used as slaves and click *Next*.
- 5 If you do not use slave servers, the slave configuration is skipped and you continue directly to the dialog for the database configuration. Here, specify the *NIS Server Maps*, the partial databases to transfer from the NIS server to the client. The default settings are usually adequate. Leave this dialog with *Next*.
- 6 Check which maps should be available and click *Next* to continue.

Figure 3.4 *NIS Server Maps Setup*

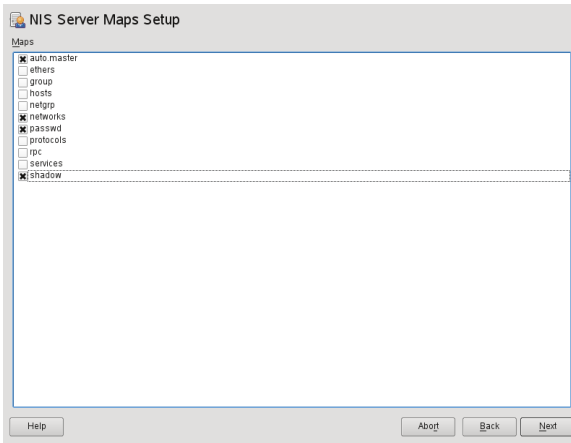

- 7** Determine which hosts are allowed to query the NIS server. You can add, edit, or delete hosts by clicking the appropriate button. Specify from which networks requests can be sent to the NIS server. Normally, this is your internal network. In this case, there should be the following two entries:

```
255.0.0.0      127.0.0.0
0.0.0.0        0.0.0.0
```

The first entry enables connections from your own host, which is the NIS server. The second one allows all hosts to send requests to the server.

Figure 3.5 *Setting Request Permissions for a NIS Server*

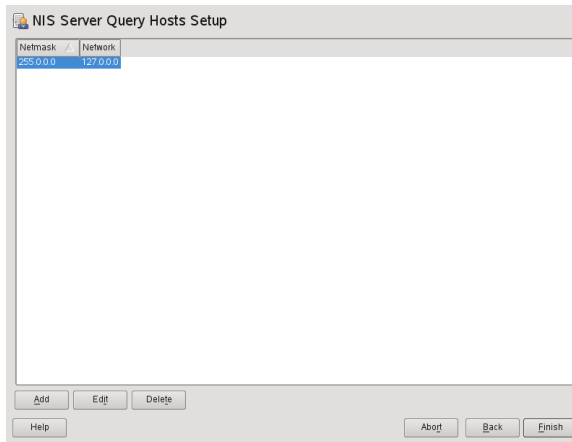

- 8 Click *Finish* to save your changes and exit the setup.

3.1.2 Configuring a NIS Slave Server

To configure additional NIS *slave servers* in your network, proceed as follows:

- 1 Start *YaST > Network Services > NIS Server*.
- 2 Select *Install and Set Up NIS Slave Server* and click *Next*.

TIP

If NIS server software is already installed on your machine, initiate the creation of a NIS slave server by clicking *Create NIS Slave Server*.

- 3 Complete the basic setup of your NIS slave server:
 - 3a Enter the NIS domain.
 - 3b Enter hostname or IP address of the master server.

3c Set *This Host is also a NIS Client* if you want to enable user logins on this server.

3d Adapt the firewall settings with *Open Ports in Firewall*.

3e Click *Next*.

4 Enter the hosts that are allowed to query the NIS server. You can add, edit, or delete hosts by clicking the appropriate button. Specify from which networks requests can be sent to the NIS server. Normally, this is all hosts. In this case, there should be the following two entries:

```
255.0.0.0      127.0.0.0
0.0.0.0        0.0.0.0
```

The first entry enables connections from your own host, which is the NIS server. The second one allows all hosts with access to the same network to send requests to the server.

5 Click *Finish* to save changes and exit the setup.

3.2 Configuring NIS Clients

To use NIS on a workstation, do the following:

- 1** Start *YaST > Network Services > NIS Client*.
- 2** Activate the *Use NIS* button.
- 3** Enter the NIS domain. This is usually a domain name given by your administrator or a static IP address received by DHCP. For information about DHCP, see Chapter 22, *DHCP* (↑*Administration Guide*).

Figure 3.6 *Setting Domain and Address of a NIS Server*

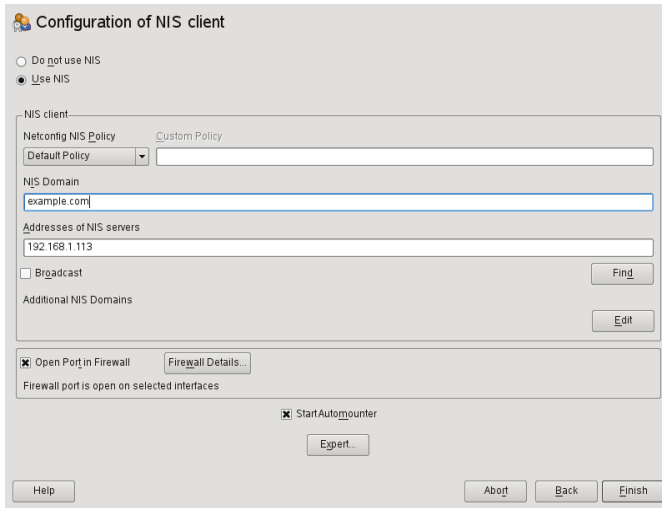

- 4 Enter your NIS servers and separate their addresses by spaces. If you do not know your NIS server, click on *Find* to let YaST search for any NIS servers in your domain. Depending on the size of your local network, this may be a time-consuming process. *Broadcast* asks for a NIS server in the local network after the specified servers fail to respond.
- 5 Depending on your local installation, you may also want to activate the auto-mounter. This option also installs additional software if required.
- 6 If you do not want other hosts to be able to query which server your client is using, go to the *Expert* settings and disable *Answer Remote Hosts*. By checking *Broken Server*, the client is enabled to receive replies from a server communicating through an unprivileged port. For further information, see `man ypbind`.
- 7 Click *Finish* to save them and return to the YaST control center. Your client is now configured with NIS.

LDAP—A Directory Service

The Lightweight Directory Access Protocol (LDAP) is a set of protocols designed to access and maintain information directories. LDAP can be used for numerous purposes, such as user and group management, system configuration management, or address management. This chapter provides a basic understanding of how OpenLDAP works and how to manage LDAP data with YaST. While there are several implementations of the LDAP protocol, this chapter focuses entirely on the OpenLDAP implementation.

It is crucial within a network environment to keep important information structured and quickly available. This can be done with a directory service that, like the common yellow pages, keeps information available in a well-structured and readily-searchable form.

Ideally, a central server keeps the data in a directory and distributes it to all clients using a certain protocol. The data is structured in a way that allows a wide range of applications to access it. That way, it is not necessary for every single calendar tool and e-mail client to keep its own database. A central repository can be accessed, instead. This notably reduces the necessary administrative effort. The use of an open and standardized protocol like LDAP ensures that as many different client applications as possible can access such information.

A directory in this context is a type of database optimized for quick and effective reading and searching:

- To make multiple concurrent reading accesses possible, the number of updates is usually very low. The number of read and write accesses is often limited to a few users with administrative privileges. Conventional databases are optimized for accepting the largest possible data volume in a short time.

- When static data is administered, updates of the existing data sets are very rare. When working with dynamic data, especially when data sets like bank accounts or accounting are concerned, the consistency of the data is of primary importance. If an amount should be subtracted from one place to be added to another, both operations must happen concurrently, within one *transaction*, to ensure balance over the data stock. Traditional relational databases usually have a very strong focus on data consistency, such as the referential integrity support of transactions. Conversely, short-term inconsistencies are usually acceptable in LDAP directories. LDAP directories often do not have such strong consistency requirements as relational databases.

The design of a directory service like LDAP is not laid out to support complex update or query mechanisms. All applications accessing this service should gain access quickly and easily.

4.1 LDAP versus NIS

The Unix system administrator traditionally uses the NIS service for name resolution and data distribution in a network. The configuration data contained in the files in `/etc` and the directories `group`, `hosts`, `mail`, `netgroup`, `networks`, `passwd`, `printcap`, `protocols`, `rpc`, and `services` are distributed by clients all over the network. These files can be maintained without major effort because they are simple text files. The handling of larger amounts of data, however, becomes increasingly difficult due to nonexistent structuring. NIS is only designed for Unix platforms, and is not suitable as a centralized data administration tool in heterogeneous networks.

Unlike NIS, the LDAP service is not restricted to pure Unix networks. Windows servers (from 2000) support LDAP as a directory service. The application tasks mentioned above are additionally supported in non-Unix systems.

The LDAP principle can be applied to any data structure that needs to be centrally administered. A few application examples are:

- Employment as a replacement for the NIS service
- Mail routing (postfix, sendmail)
- Address books for mail clients, like Mozilla, Evolution, and Outlook

- Administration of zone descriptions for a BIND9 name server
- User authentication with Samba in heterogeneous networks

This list can be extended because LDAP is extensible, unlike NIS. The clearly-defined hierarchical structure of the data eases the administration of large amounts of data, as it can be searched more easily.

4.2 Structure of an LDAP Directory Tree

To get a deep background knowledge on how a LDAP server works and how the data is stored, it is vital to understand the way the data is organized on the server and how this structure enables LDAP to provide fast access to the data you need. To successfully operate an LDAP setup, you also need to be familiar with some basic LDAP terminology. This section introduces the basic layout of an LDAP directory tree and provides the basic terminology used with respect to LDAP. Skip this introductory section if you already have some LDAP background knowledge and just want to learn how to set up an LDAP environment in SUSE Linux Enterprise Server. Read on at Section 4.3, “Configuring an LDAP Server with YaST” (page 42) or Section 4.7, “Manually Configuring an LDAP Server” (page 62), respectively.

An LDAP directory has a tree structure. All entries (called objects) of the directory have a defined position within this hierarchy. This hierarchy is called the *directory information tree* (DIT). The complete path to the desired entry, which unambiguously identifies it, is called the *distinguished name* or DN. A single node along the path to this entry is called *relative distinguished name* or RDN.

The relations within an LDAP directory tree become more evident in the following example, shown in Figure 4.1, “Structure of an LDAP Directory” (page 40).

Figure 4.1 Structure of an LDAP Directory

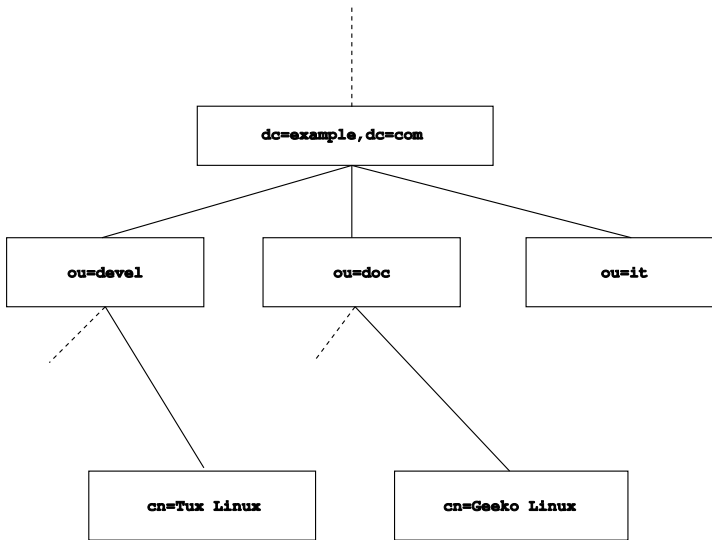

The complete diagram is a fictional directory information tree. The entries on three levels are depicted. Each entry corresponds to one box in the image. The complete, valid *distinguished name* for the fictional employee `Geeko Linux`, in this case, is `cn=Geeko Linux, ou=doc, dc=example, dc=com`. It is composed by adding the RDN `cn=Geeko Linux` to the DN of the preceding entry `ou=doc, dc=example, dc=com`.

The types of objects that can be stored in the DIT are globally determined following a *Schema*. The type of an object is determined by the *object class*. The object class determines what attributes the relevant object must or can be assigned. The Schema, therefore, must contain definitions of all object classes and attributes used in the desired application scenario. There are a few common Schemas (see RFC 2252 and 2256). The LDAP RFC defines a few commonly used Schemas (see e.g., RFC4519). Additionally there are Schemas available for many other use cases (e.g., Samba, NIS replacement, etc.). It is, however, possible to create custom Schemas or to use multiple Schemas complementing each other (if this is required by the environment in which the LDAP server should operate).

Table 4.1, “Commonly Used Object Classes and Attributes” (page 41) offers a small overview of the object classes from `core.schema` and `inetorgperson.schema` used in the example, including required attributes and valid attribute values.

Table 4.1 *Commonly Used Object Classes and Attributes*

Object Class	Meaning	Example Entry	Required Attributes
dcObject	<i>domainComponent</i> (name components of the domain)	example	dc
organizationalUnit	<i>organizationalUnit</i> (organizational unit)	doc	ou
inetOrgPerson	<i>inetOrgPerson</i> (person-related data for the intranet or Internet)	Geeko Linux	sn and cn

Example 4.1, “Excerpt from schema.core” (page 41) shows an excerpt from a Schema directive with explanations (line numbering for explanatory reasons).

Example 4.1 *Excerpt from schema.core*

```
#1 attributetype (2.5.4.11 NAME ( 'ou' 'organizationalUnitName')
#2     DESC 'RFC2256: organizational unit this object belongs to'
#3     SUP name )
...
#4 objectclass ( 2.5.6.5 NAME 'organizationalUnit'
#5     DESC 'RFC2256: an organizational unit'
#6     SUP top STRUCTURAL
#7     MUST ou
#8 MAY (userPassword $ searchGuide $ seeAlso $ businessCategory
    $ x121Address $ registeredAddress $ destinationIndicator
    $ preferredDeliveryMethod $ telexNumber
    $ teletexTerminalIdentifier $ telephoneNumber
    $ internationalISDNNumber $ facsimileTelephoneNumber
    $ street $ postOfficeBox $ postalCode $ postalAddress
    $ physicalDeliveryOfficeName
    $ st $ l $ description) )
...
```

The attribute type `organizationalUnitName` and the corresponding object class `organizationalUnit` serve as an example here. Line 1 features the name of the attribute, its unique OID (*object identifier*) (numerical), and the abbreviation of the attribute.

Line 2 gives a brief description of the attribute with `DESC`. The corresponding RFC on which the definition is based is also mentioned here. `SUP` in line 3 indicates a superordinate attribute type to which this attribute belongs.

The definition of the object class `organizationalUnit` begins in line 4, like in the definition of the attribute, with an `OID` and the name of the object class. Line 5 features a brief description of the object class. Line 6, with its entry `SUP top`, indicates that this object class is not subordinate to another object class. Line 7, starting with `MUST`, lists all attribute types that must be used in conjunction with an object of the type `organizationalUnit`. Line 8, starting with `MAY`, lists all attribute types that are permitted in conjunction with this object class.

A very good introduction to the use of Schemas can be found in the documentation of OpenLDAP. When installed, find it in `/usr/share/doc/packages/openldap2/guide/admin/guide.html`.

4.3 Configuring an LDAP Server with YaST

Use YaST to set up an LDAP server. Typical use cases for LDAP servers include the management of user account data and the configuration of mail, DNS, and DHCP servers.

Figure 4.2 *YaST LDAP Server Configuration*

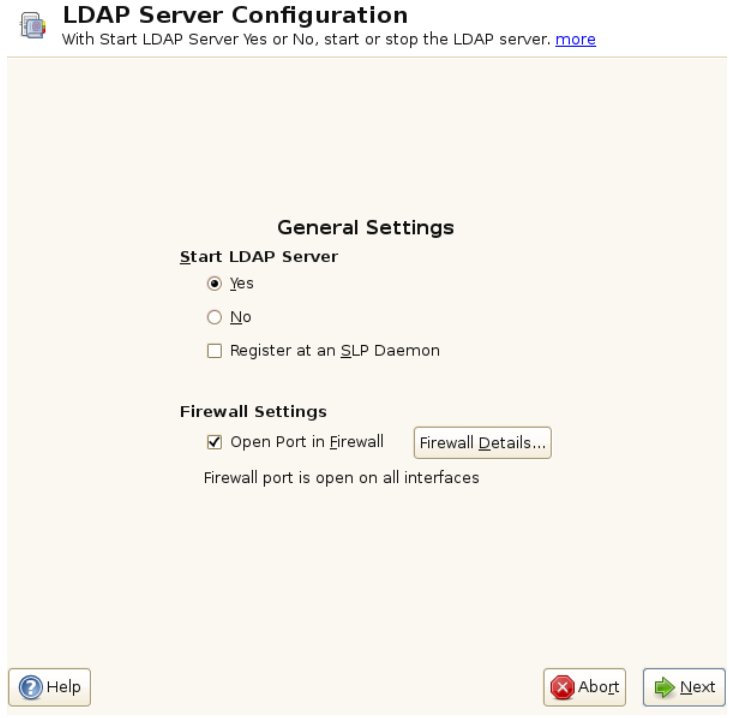



Figure 4.3 *YaST LDAP Server—New Database*

 **New Database**
Choose the Database from hdb and bdb. [more](#)

Basic Database Settings

Database Type:

Base DN:

Administrator DN:
 Append Base DN

LDAP Administrator Password:

Validate Password:

Database Directory:

Use this database as the default for OpenLDAP clients

To set up an LDAP server for user account data, make sure the `yast2-ldap-server` and `openldap2` packages and packages they depend on are installed. Then proceed as follows:

- 1** Log in as `root`.
- 2** Start YaST and select *Network Services > LDAP Server* to invoke the configuration wizard.
- 3** Configure the *Global Settings* of your LDAP server (you can change these settings later)—see Figure 4.2, “YaST LDAP Server Configuration” (page 43):
 - 3a** Set LDAP to be started.
 - 3b** If the LDAP server should announce its services via SLP, check *Register at an SLP Daemon*.

3c Configure *Firewall Settings*.

3d Click *Next*.

4 Select the server type: stand-alone server, master server in a replication setup, or replication (slave) server.

5 Select security options (*TLS Settings*).

Consider to *Enable TLS*. TLS is an encryption technology. For more information, see Step 4 (page 47).

Also consider to use LDAP over SSL and certificates.

6 Confirm *Basic Database Settings* with entering an *LDAP Administrator Password* and then clicking *Next*—see Figure 4.2, “YaST LDAP Server Configuration” (page 43).

7 Check the *LDAP Server Configuration Summary* and click *Finish* to exit the configuration wizard.

Figure 4.4 *YaST LDAP Server Configuration*



For changes or additional configuration start the LDAP server module again and in the left pane expand *Global Settings* to make subentries visible—see Figure 4.4, “YaST LDAP Server Configuration” (page 46):

- 1 With *Log Level Settings*, configure the degree of logging activity (verbosity) of the LDAP server. From the predefined list, select or deselect the logging options according to your needs. The more options are enabled, the larger your log files grow.
- 2 From *Allow/Disallow Features* determine the connection types the LDAP server should allow. Choose from:

LDAPv2 Bind Requests

This option enables connection requests (bind requests) from clients using the previous version of the protocol (LDAPv2).

Anonymous Bind When Credentials Not Empty

Normally the LDAP server denies any authentication attempts with empty credentials (DN or password). Enabling this option, however, makes it possible to connect with a password and no DN to establish an anonymous connection.

Unauthenticated Bind When DN Not Empty

Enabling this option makes it possible to connect without authentication (anonymously) using a DN but no password.

Unauthenticated Update Options to Process

Enabling this option allows non-authenticated (anonymous) update operations. Access is restricted according to ACLs and other rules .

- 3** Then from *Allow/Disallow Features* determine which flags the LDAP server should disallow. Choose from:

Disable Acceptance of Anonymous Bind Requests

The Server will no longer accept anonymous bind request. Note, that this does not generally prohibit anonymous directory access.

Disable Simple Bind Authentication

Completely disable Simple Bind authentication.

Disable Forcing Session to Anonymous Status upon StartTLS Operation Receipt

The server will no longer force an authenticated connection back to the anonymous state when receiving the StartTLS operation.

Disallow the StartTLS Operation if Authenticated

The server will disallow the StartTLS operation on already authenticated connections.

- 4** To configure secure communication between client and server, proceed with *TLS Settings*:

4a Activate *Enable TLS* to enable TLS and SSL encryption of the client/server communication.

4b Either *Import Certificate* by specifying the exact path to its location or enable the *Use Common Server Certificate*. If the *Use Common Server Certificate* is not available because it has not been created during installation, go for

Launch CA Management Module first— for more information, see Section 17.2, “YaST Modules for CA Management” (page 207).

Add Schema files to be included in the server's configuration by selecting *Schema Files* in the left part of the dialog. The default selection of schema files applies to the server providing a source of YaST user account data.

YaST allows to add traditional Schema files (usually with a name ending in `.schema`) or LDIF files containing Schema definitions in OpenLDAP's LDIF Schema format.

Figure 4.5 *YaST LDAP Server Database Configuration*

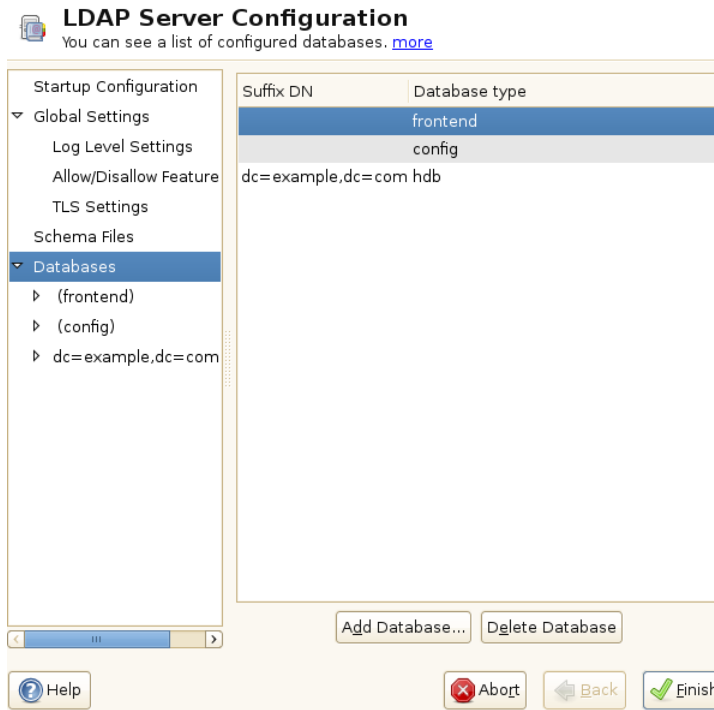

To configure the databases managed by your LDAP server, proceed as follows:

- 1 Select the *Databases* item in the left part of the dialog.
- 2 Click *Add Database* to add the new database.

3 Enter the requested data:

Base DN

Enter the base DN of your LDAP server.

Administrator DN

Enter the DN of the administrator in charge of the server. If you check *Append Base DN*, only provide the `cn` of the administrator and the system fills in the rest automatically.

LDAP Administrator Password

Enter the password for the database administrator.

Use This Database as the Default for OpenLDAP Clients

For convenience, check this option if wanted.

4 In the next dialog configure replication settings.

5 In the next dialog, enable enforcement of password policies to provide extra security to your LDAP server:

5a Check *Enable Password Policies* to be able to specify a password policy.

5b Activate *Hash Clear Text Passwords* to have clear text passwords be hashed before they are written to the database whenever they are added or modified.

5c *Disclose "Account Locked" Status* provides a relevant error message for bind requests to locked accounts.

WARNING: Locked Accounts in Security Sensitive Environments

Do not use the *Disclose "Account Locked" Status* option if your environment is sensitive to security issues, because the “Locked Account” error message provides security-sensitive information that can be exploited by a potential attacker.

5d Enter the DN of the default policy object. To use a DN other than the one suggested by YaST, enter your choice. Otherwise, accept the default settings.

6 Complete the database configuration by clicking *Finish*.

If you have not opted for password policies, your server is ready to run at this point. If you chose to enable password policies, proceed with the configuration of the password policy in detail. If you chose a password policy object that does not yet exist, YaST creates one:

- 1** Enter the LDAP server password. In the navigation tree below *Databases* expand your database object and activate the *Password Policy Configuration* item.
- 2** Make sure *Enable Password Policies* is activated. Then click *Edit Policy*.
- 3** Configure the password change policies:
 - 3a** Determine the number of passwords stored in the password history. Saved passwords may not be reused by the user.
 - 3b** Determine if users will be able to change their passwords and if they will need to change their passwords after a reset by the administrator. Require the old password for password changes (optional).
 - 3c** Determine whether and to what extent passwords should be subject to quality checking. Set the minimum password length that must be met before a password is valid. If you select *Accept Uncheckable Passwords*, users are allowed to use encrypted passwords, even though the quality checks cannot be performed. If you opt for *Only Accept Checked Passwords* only those passwords that pass the quality tests are accepted as valid.
- 4** Configure the password time-limit policies:
 - 4a** Determine the minimum password time-limit (the time that needs to pass between two valid password changes) and the maximum password time-limit.
 - 4b** Determine the time between a password expiration warning and the actual password expiration.
 - 4c** Set the number of postponement uses of an expired password before the password expires permanently.
- 5** Configure the lockout policies:

- 5a** Enable password locking.
 - 5b** Determine the number of bind failures that trigger a password lock.
 - 5c** Determine the duration of the password lock.
 - 5d** Determine the length of time that password failures are kept in the cache before they are purged.
- 6** Apply your password policy settings with *OK*.

To edit a previously created database, select its base DN in the tree to the left. In the right part of the window, YaST displays a dialog similar to the one used for the creation of a new database (with the main difference that the base DN entry is grayed out and cannot be changed).

After leaving the LDAP server configuration by selecting *Finish*, you are ready to go with a basic working configuration for your LDAP server. To fine-tune this setup, make use of OpenLDAP's dynamic configuration backend.

The OpenLDAP's dynamic configuration backend stores the configuration in an LDAP database. That database consists of a set of `.ldif` files in `/etc/openldap/slapd.d`. There is no need to access these files directly. To access the settings you can either use the YaST LDAP server module (the `yast2-ldap-server` package) or an LDAP client such as `ldapmodify` or `ldapsearch`. For more information on the dynamic configuration of OpenLDAP, see the OpenLDAP Administration Guide.

4.4 Configuring an LDAP Client with YaST

YaST includes a module to set up LDAP-based user management. If you did not enable this feature during the installation, start the module by selecting *Network Services > LDAP Client*. YaST automatically enables any PAM and NSS-related changes as required by LDAP and installs the necessary files. Simply connect your client to the server and let YaST manage users over LDAP. This basic setup is described in Section 4.4.1, “Configuring Basic Settings” (page 52).

Use the YaST LDAP client to further configure the YaST group and user configuration modules. This includes manipulating the default settings for new users and groups and the number and nature of the attributes assigned to a user or group. LDAP user management allows you to assign far more and different attributes to users and groups than traditional user or group management solutions. This is described in Section 4.4.2, “Configuring the YaST Group and User Administration Modules” (page 55).

4.4.1 Configuring Basic Settings

The basic LDAP client configuration dialog (Figure 4.6, “YaST: LDAP Client Configuration” (page 52)) opens during installation if you choose LDAP user management or when you select *Network Services > LDAP Client* in the YaST Control Center in the installed system.

Figure 4.6 *YaST: LDAP Client Configuration*

more'. It features several sections: 'User Authentication' with radio buttons for 'Do Not Use LDAP', 'Use LDAP' (selected), and 'Use LDAP but Disable Logins'; 'LDAP Client' with input fields for 'Addresses of LDAP Servers' (containing '192.168.1.113') and 'LDAP Base DN' (containing 'dc=example,dc=com'), each with a 'Find' or 'Fetch DN' button; checkboxes for 'LDAP TLS/SSL', 'LDAP Version 2', 'Start Automounter', and 'Create Home Directory on Login'; and an 'Advanced Configuration...' button. At the bottom are buttons for 'Help', 'Abort', 'Back', and 'Finish'."/>

LDAP Client Configuration
Here, your machine can be set up as an LDAP client. [more](#)

User Authentication

Do Not Use LDAP

Use LDAP

Use LDAP but Disable Logins

LDAP Client

Addresses of LDAP Servers:

LDAP Base DN:

LDAP TLS/SSL

LDAP Version 2

Start Automounter

Create Home Directory on Login

To authenticate users of your machine against an OpenLDAP server and to enable user management via OpenLDAP, proceed as follows:

- 1** Click *Use LDAP* to enable the use of LDAP. Select *Use LDAP but Disable Logins* if instead you want to use LDAP for authentication, but do not want other users to log in to this client.
- 2** Enter the IP address of the LDAP server to use.
- 3** Enter the *LDAP Base DN* to select the search base on the LDAP server. To retrieve the base DN automatically, click *Fetch DN*. YaST then checks for any LDAP database on the server address specified above. Choose the appropriate base DN from the search results given by YaST.
- 4** If TLS or SSL-protected communication with the server is required, select *LDAP TLS/SSL*.
- 5** If the LDAP server still uses LDAPv2, enable the use of this protocol version by selecting *LDAP Version 2*.
- 6** Select *Start Automounter* to mount remote directories on your client, such as a remotely managed `/home`.
- 7** Select *Create Home Directory on Login* to have a user's home automatically created on the first user login.
- 8** Click *Ok* to apply your settings.

To modify data on the server as administrator, click *Advanced Configuration*. The following dialog is split into two tabs. See Figure 4.7, “YaST: Advanced Configuration” (page 54).

Figure 4.7 *YaST: Advanced Configuration*



- 1** In the *Client Settings* tab, adjust the following settings according to your needs:
 - 1a** If the search base for users, passwords, and groups differs from the global search base specified in the *LDAP base DN*, enter these different naming contexts in *User Map*, *Password Map*, and *Group Map*.
 - 1b** Specify the password change protocol. The standard method to use whenever a password is changed is `crypt`, meaning that password hashes generated by `crypt` are used. For details on this and other options, refer to the `pam_ldap` man page.
 - 1c** Specify the LDAP group to use with *Group Member Attribute*. The default value for this is `member`.

- 2** In *Administration Settings*, adjust the following settings:
 - 2a** Set the base for storing your user management data via *Configuration Base DN*.
 - 2b** Enter the appropriate value for *Administrator DN*. This DN must be identical with the `rootdn` value specified in `/etc/openldap/slapd.conf` to enable this particular user to manipulate data stored on the LDAP server. Enter the full DN (such as `cn=Administrator,dc=example,dc=com`) or activate *Append Base DN* to have the base DN added automatically when you enter `cn=Administrator`.
 - 2c** Check *Create Default Configuration Objects* to create the basic configuration objects on the server to enable user management via LDAP.
 - 2d** If your client machine needs to act as a file server for home directories across your network, check *Home Directories on This Machine*.
 - 2e** Use the *Password Policy* section to select, add, delete, or modify the password policy settings to use. The configuration of password policies with YaST is part of the LDAP server setup.
 - 2f** Click *OK* to leave the *Advanced Configuration*, then *Finish* to apply your settings.

Use *Configure User Management Settings* to edit entries on the LDAP server. Access to the configuration modules on the server is then granted according to the ACLs and ACIs stored on the server. Follow the procedures outlined in Section 4.4.2, “Configuring the YaST Group and User Administration Modules” (page 55).

4.4.2 Configuring the YaST Group and User Administration Modules

Use the YaST LDAP client to adapt the YaST modules for user and group administration and to extend them as needed. Define templates with default values for the individual attributes to simplify the data registration. The presets created here are stored as LDAP

objects in the LDAP directory. The registration of user data is still done with the regular YaST modules for user and group management. The registered data is stored as LDAP objects on the server.

Figure 4.8 *YaST: Module Configuration*

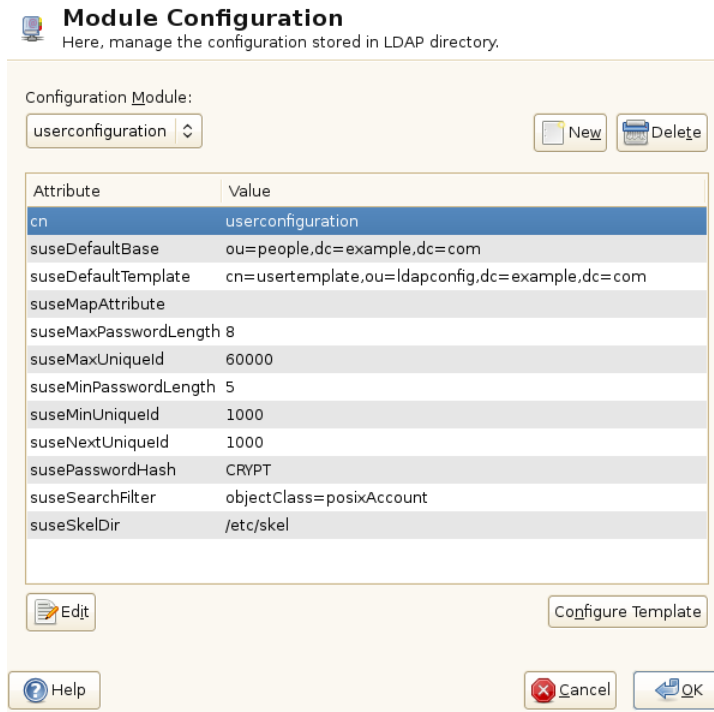

The dialog for module configuration (Figure 4.8, “YaST: Module Configuration” (page 56)) allows the creation of new modules, selection and modification of existing configuration modules, and design and modification of templates for such modules.

To create a new configuration module, proceed as follows:

- 1 In the *LDAP Client Configuration* click *Advanced Configuration*, then open the *Administration Settings* tab. Click *Configure User Management Settings* and enter the LDAP server credentials.

- 2** Click *New* and select the type of module to create. For a user configuration module, select `suseuserconfiguration` and for a group configuration choose `susegroupconfiguration`.
- 3** Choose a name for the new template. The content view then features a table listing all attributes allowed in this module with their assigned values. Apart from all set attributes, the list also contains all other attributes allowed by the current Schema, but currently not used.
- 4** Accept the preset values or adjust the defaults to use in group and user configurations by selecting the relevant attribute, pressing *Edit*, and entering the new value. Rename a module by simply changing the `cn` attribute of the module. Clicking *Delete* deletes the currently selected module.
- 5** After you click *OK*, the new module is added to the selection menu.

The YaST modules for group and user administration embed templates with standard values. To edit a template associated with a configuration module, proceed as follows:

- 1** In the *Module Configuration* dialog, click *Configure Template*.
- 2** Determine the values of the general attributes assigned to this template according to your needs or leave them empty. Empty attributes are deleted on the LDAP server.
- 3** Modify, delete, or add new default values for new objects (user or group configuration objects in the LDAP tree).

Figure 4.9 *YaST: Configuration of an Object Template*



Connect the template to its module by setting the `susedefaulttemplate` attribute value of the module to the DN of the adapted template.

TIP

The default values for an attribute can be created from other attributes by using a variable instead of an absolute value. For example, when creating a new user, `cn=%sn %givenName` is created automatically from the attribute values for `sn` and `givenName`.

Once all modules and templates are configured correctly and ready to run, new groups and users can be registered in the usual way with YaST.

4.5 Configuring LDAP Users and Groups in YaST

The actual registration of user and group data differs only slightly from the procedure when not using LDAP. The following instructions relate to the administration of users. The procedure for administering groups is analogous.

- 1** Access the YaST user administration with *Security and Users > User and Group Management*.
- 2** Use *Set Filter* to limit the view of users to the LDAP users and enter the password for Root DN.
- 3** Click *Add* and enter the configuration of a new user. A dialog with four tabs opens:
 - 3a** Specify username, login, and password in the *User Data* tab.
 - 3b** Check the *Details* tab for the group membership, login shell, and home directory of the new user. If necessary, change the default to values that better suit your needs. The default values (as well as those of the password settings) can be defined with the procedure described in Section 4.4.2, “Configuring the YaST Group and User Administration Modules” (page 55).
 - 3c** Modify or accept the default *Password Settings*.
 - 3d** Enter the *Plug-Ins* tab, select the LDAP plug-in, and click *Launch* to configure additional LDAP attributes assigned to the new user (see Figure 4.10, “YaST: Additional LDAP Settings” (page 60)).
- 4** Click *OK* to apply your settings and leave the user configuration.

Figure 4.10 *YaST: Additional LDAP Settings*

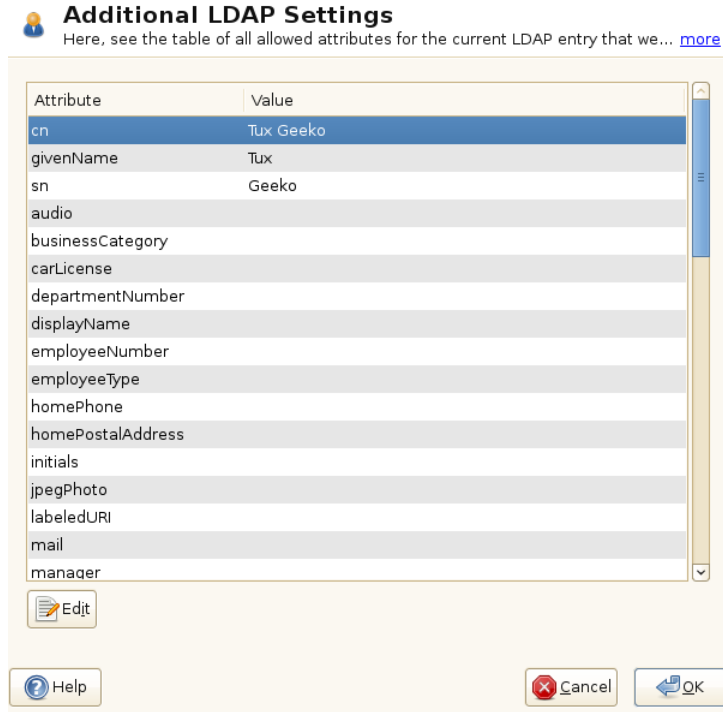

The initial input form of user administration offers *LDAP Options*. This allows you to apply LDAP search filters to the set of available users (or go to the module for the configuration of LDAP users and groups by selecting *LDAP User and Group Configuration*).

4.6 Browsing the LDAP Directory Tree

To conveniently browse the LDAP directory tree and all its entries, use the YaST LDAP Browser:

- 1 Log in as `root`.
- 2 Start *YaST > Network Services > LDAP Browser*.
- 3 Enter the address of the LDAP server, the Administrator DN, and the password for the Root DN of this server (if you need both to read and write the data stored on the server).

Alternatively, choose *Anonymous Access* and do not provide the password to gain read access to the directory.

The *LDAP Tree* tab displays the content of the LDAP directory to which your machine connected. Click to expand each item's submenu.

Figure 4.11 *Browsing the LDAP Directory Tree*

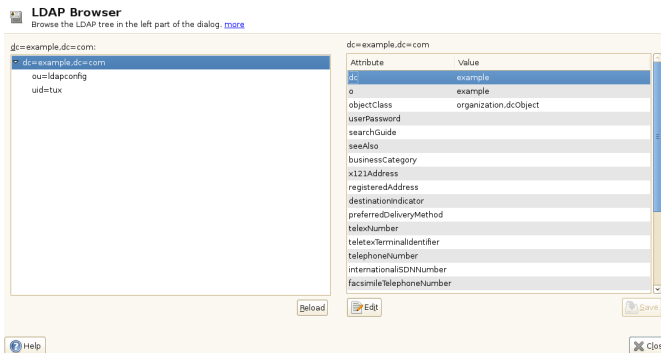

- 4 To view any entry in detail, select it in the *LDAP Tree* view and open the *Entry Data* tab.

All attributes and values associated with this entry are displayed.

Figure 4.12 *Browsing the Entry Data*

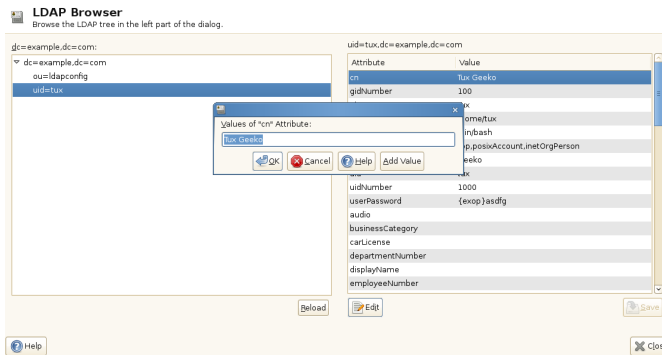

- 5 To change the value of any of these attributes, select the attribute, click *Edit*, enter the new value, click *Save*, and provide the Root DN password when prompted.
- 6 Leave the LDAP browser with *Close*.

4.7 Manually Configuring an LDAP Server

YaST does not use `/etc/openldap/slapd.conf` to store the OpenLDAP configuration anymore. YaST uses OpenLDAP's dynamic configuration database (`back-config`) to store the LDAP server's configuration. For details about the dynamic configuration backend please see the `slapd-config(5)` man page or the OpenLDAP Software 2.4 Administrator's Guide located at `/usr/share/doc/packages/openldap2/guide/admin/guide.html` on this system if the `openldap2` package is installed.

In case of a system upgrade, a copy of the original `/etc/openldap/slapd.conf` file will get created as `/etc/openldap/slapd.conf.YaSTsave`.

To conveniently access the new configuration backend, you can use SASL external authentication. For example, the following `ldapsearch` command executed as `root` can be used to print the complete `slapd` configuration to `stdout`:

```
ldapsearch -Y external -H ldapi:/// -b cn=config
```

4.7.1 Starting and Stopping the Servers

Once the LDAP server is fully configured and all desired entries have been made according to the pattern described in Section 4.8, “Manually Administering LDAP Data” (page 63), start the LDAP server as `root` by entering `rcldap start`. To stop the server manually, enter the command `rcldap stop`. Request the status of the running LDAP server with `rcldap status`.

The YaST runlevel editor, described in Section “Configuring System Services (Runlevel) with YaST” (Chapter 7, *Booting and Configuring a Linux System, Administration Guide*), can be used to have the server started and stopped automatically on bootup and shutdown of the system. It is also possible to create the corresponding links to the start and stop scripts with the `insserv` command from a command prompt as described in Section “Init Scripts” (Chapter 7, *Booting and Configuring a Linux System, Administration Guide*).

4.8 Manually Administering LDAP Data

OpenLDAP offers a series of tools for the administration of data in the LDAP directory. The four most important tools for adding to, deleting from, searching through and modifying the data stock are explained in this section.

4.8.1 Inserting Data into an LDAP Directory

Once your LDAP server is correctly configured (it features appropriate entries for `suffix`, `directory`, `rootdn`, `rootpw` and `index`), proceed to entering records. OpenLDAP offers the `ldapadd` command for this task. If possible, add the objects to the database in bundles (for practical reasons). LDAP is able to process the LDIF format

(LDAP data interchange format) for this. An LDIF file is a simple text file that can contain an arbitrary number of attribute and value pairs. The LDIF file for creating a rough framework for the example in Figure 4.1, “Structure of an LDAP Directory” (page 40) would look like the one in Example 4.2, “An LDIF File” (page 64).

IMPORTANT: Encoding of LDIF Files

LDAP works with UTF-8 (Unicode). Umlauts must be encoded correctly. Otherwise, avoid umlauts and other special characters or use `iconv` to convert the input to UTF-8.

Example 4.2 *An LDIF File*

```
# The Organization
dn: dc=example,dc=com
objectClass: dcObject
objectClass: organization
o: Example dc: example

# The organizational unit development (devel)
dn: ou=devel,dc=example,dc=com
objectClass: organizationalUnit
ou: devel

# The organizational unit documentation (doc)
dn: ou=doc,dc=example,dc=com
objectClass: organizationalUnit
ou: doc

# The organizational unit internal IT (it)
dn: ou=it,dc=example,dc=com
objectClass: organizationalUnit
ou: it
```

Save the file with the `.ldif` suffix then pass it to the server with the following command:

```
ldapadd -x -D <dn of the administrator> -W -f <file>.ldif
```

`-x` switches off the authentication with SASL in this case. `-D` declares the user that calls the operation. The valid DN of the administrator is entered here just like it has been configured in `slapd.conf`. In the current example, this is `cn=Administrator,dc=example,dc=com`. `-W` circumvents entering the password on the command line (in clear text) and activates a separate password prompt. The `-f` option passes the filename. See the details of running `ldapadd` in Example 4.3, “`ldapadd` with `example.ldif`” (page 65).

Example 4.3 *ldapadd with example.ldif*

```
ldapadd -x -D cn=Administrator,dc=example,dc=com -W -f example.ldif

Enter LDAP password:
adding new entry "dc=example,dc=com"
adding new entry "ou=devel,dc=example,dc=com"
adding new entry "ou=doc,dc=example,dc=com"
adding new entry "ou=it,dc=example,dc=com"
```

The user data of individuals can be prepared in separate LDIF files. Example 4.4, “LDIF Data for Tux” (page 65) adds Tux to the new LDAP directory.

Example 4.4 *LDIF Data for Tux*

```
# coworker Tux
dn: cn=Tux Linux,ou=devel,dc=example,dc=com
objectClass: inetOrgPerson
cn: Tux Linux
givenName: Tux
sn: Linux
mail: tux@example.com
uid: tux
telephoneNumber: +49 1234 567-8
```

An LDIF file can contain an arbitrary number of objects. It is possible at once to pass directory branches (entirely or in part) to the server as shown in the example of individual objects. If it is necessary to modify some data relatively often, a fine subdivision of single objects is recommended.

4.8.2 Modifying Data in the LDAP Directory

The tool `ldapmodify` is provided for modifying the data stock. The easiest way to do this is to modify the corresponding LDIF file then pass this modified file to the LDAP server. To change the telephone number of colleague Tux from +49 1234 567-8 to +49 1234 567-10, edit the LDIF file like in Example 4.5, “Modified LDIF File tux.ldif” (page 65).

Example 4.5 *Modified LDIF File tux.ldif*

```
# coworker Tux
dn: cn=Tux Linux,ou=devel,dc=example,dc=com
changetype: modify
replace: telephoneNumber
telephoneNumber: +49 1234 567-10
```

Import the modified file into the LDAP directory with the following command:

```
ldapmodify -x -D cn=Administrator,dc=example,dc=com -W -f tux.ldif
```

Conversely, pass the attributes to change directly to `ldapmodify`. The procedure for this is described below:

1 Start `ldapmodify` and enter your password:

```
ldapmodify -x -D cn=Administrator,dc=example,dc=com -W
Enter LDAP password:
```

2 Enter the changes while carefully complying with the syntax in the order presented below:

```
dn: cn=Tux Linux,ou=devel,dc=example,dc=com
changetype: modify
replace: telephoneNumber
telephoneNumber: +49 1234 567-10
```

Find detailed information about `ldapmodify` and its syntax in the `ldapmodify` man page.

4.8.3 Searching or Reading Data from an LDAP Directory

OpenLDAP provides, with `ldapsearch`, a command line tool for searching data within an LDAP directory and reading data from it. A simple query would have the following syntax:

```
ldapsearch -x -b dc=example,dc=com "(objectClass=*)"
```

The `-b` option determines the search base (the section of the tree within which the search should be performed). In the current case, this is `dc=example,dc=com`. To perform a more finely-grained search in specific subsections of the LDAP directory (for example, only within the `devel` department), pass this section to `ldapsearch` with `-b`. `-x` requests activation of simple authentication. `(objectClass=*)` declares that all objects contained in the directory should be read. This command option can be used after the creation of a new directory tree to verify that all entries have been recorded correctly and the server responds as desired. Find more information about the use of `ldapsearch` in the corresponding man page (`ldapsearch(1)`).

4.8.4 Deleting Data from an LDAP Directory

Delete unwanted entries with `ldapdelete`. The syntax is similar to that of the other commands. To delete, for example, the complete entry for Tux Linux, issue the following command:

```
ldapdelete -x -D cn=Administrator,dc=example,dc=com -W cn=Tux \
Linux,ou=devel,dc=example,dc=com
```

4.9 For More Information

More complex subjects (like SASL configuration or establishment of a replicating LDAP server that distributes the workload among multiple slaves) were intentionally omitted from this chapter. Detailed information about both subjects can be found in the *OpenLDAP 2.4 Administrator's Guide*—see at *OpenLDAP 2.4 Administrator's Guide* (page 67).

The Web site of the OpenLDAP project offers exhaustive documentation for beginner and advanced LDAP users:

OpenLDAP FAQ-O-Matic

A detailed question and answer collection applying to the installation, configuration, and use of OpenLDAP. Find it at <http://www.openldap.org/faq/data/cache/1.html>.

Quick Start Guide

Brief step-by-step instructions for installing your first LDAP server. Find it at <http://www.openldap.org/doc/admin24/quickstart.html> or on an installed system in Section 2 of `/usr/share/doc/packages/openldap2/guide/admin/guide.html`.

OpenLDAP 2.4 Administrator's Guide

A detailed introduction to all important aspects of LDAP configuration, including access controls and encryption. See <http://www.openldap.org/doc/admin24/> or, on an installed system, `/usr/share/doc/packages/openldap2/guide/admin/guide.html`.

Understanding LDAP

A detailed general introduction to the basic principles of LDAP: <http://www.redbooks.ibm.com/redbooks/pdfs/sg244986.pdf>.

Printed literature about LDAP:

- *LDAP System Administration* by Gerald Carter (ISBN 1-56592-491-6)
- *Understanding and Deploying LDAP Directory Services* by Howes, Smith, and Good (ISBN 0-672-32316-8)

The ultimate reference material for the subject of LDAP is the corresponding RFCs (request for comments), 2251 to 2256.

Active Directory Support

Active Directory* (AD) is a directory-service based on LDAP, Kerberos, and other services that is used by Microsoft Windows to manage resources, services, and people. In an MS Windows network, AD provides information about these objects, restricts access to them, and enforces policies. SUSE® Linux Enterprise Server lets you join existing AD domains and integrate your Linux machine into a Windows environment.

5.1 Integrating Linux and AD Environments

With a Linux client (configured as an Active Directory client) that is joined to an existing Active Directory domain, benefit from various features not available on a pure SUSE Linux Enterprise Server Linux client:

Browsing Shared Files and Folders with SMB

Both Nautilus (the GNOME file manager) and Konqueror (its KDE counterpart) support browsing shared resources through SMB.

Sharing Files and Folders with SMB

Both Nautilus (the GNOME file manager) and Konqueror (its KDE counterpart) support sharing folders and files as in Windows.

Accessing and Manipulating User Data on the Windows Server

Through Nautilus and Konqueror, users are able to access their Windows user data and can edit, create, and delete files and folders on the Windows server. Users can access their data without having to enter their password multiple times.

Offline Authentication

Users are able to log in and access their local data on the Linux machine even if they are offline or the AD server is unavailable for other reasons.

Windows Password Change

This port of AD support in Linux enforces corporate password policies stored in Active Directory. The display managers and console support password change messages and accept your input. You can even use the Linux `passwd` command to set Windows passwords.

Single-Sign-On through Kerberized Applications

Many applications of both desktops are Kerberos-enabled (*kerberized*), which means they can transparently handle authentication for the user without the need for password reentry at Web servers, proxies, groupware applications, or other locations.

A brief technical background for most of these features is given in the following section.

5.2 Background Information for Linux AD Support

Many system components need to interact flawlessly in order to integrate a Linux client into an existing Windows Active Directory domain. Figure 5.1, “Active Directory Authentication Schema” (page 71) highlights the most prominent ones. The following sections focus on the underlying processes of the key events in AD server and client interaction.

Figure 5.1 Active Directory Authentication Schema

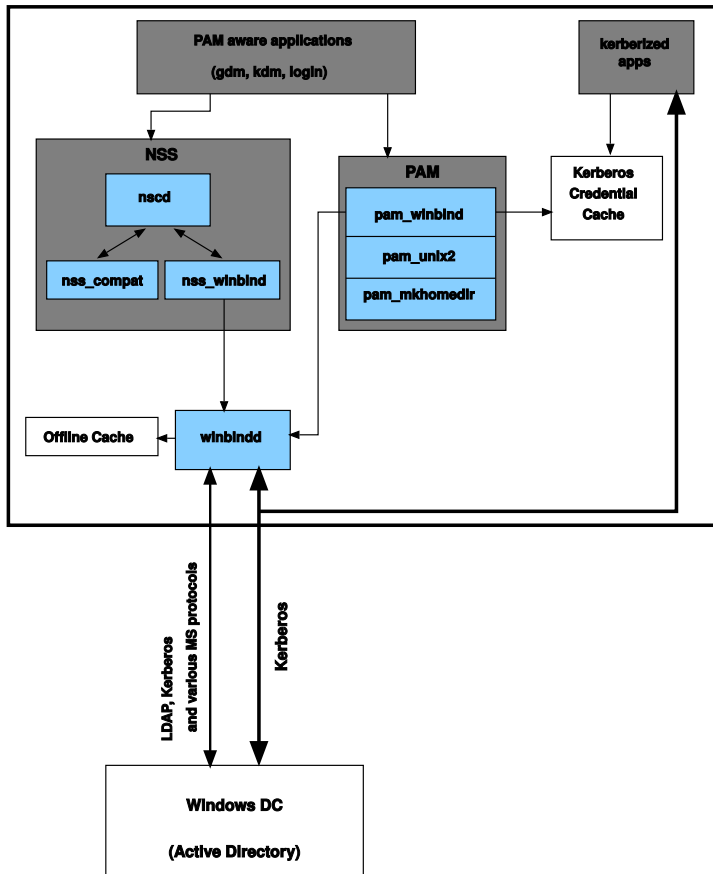

To communicate with the directory service, the client needs to share at least two protocols with the server:

LDAP

LDAP is a protocol optimized for managing directory information. A Windows domain controller with AD can use the LDAP protocol to exchange directory information with the clients. To learn more about LDAP in general and about the open source port of it, OpenLDAP, refer to Chapter 4, *LDAP—A Directory Service* (page 37).

Kerberos

Kerberos is a third-party trusted authentication service. All its clients trust Kerberos's authorization of another client's identity, enabling kerberized single-sign-on (SSO) solutions. Windows supports a Kerberos implementation, making Kerberos SSO possible even with Linux clients. To learn more about Kerberos in Linux, refer to Chapter 6, *Network Authentication with Kerberos* (page 83).

The following client components process account and authentication data:

Winbind

The most central part of this solution is the winbind daemon that is a part of the Samba project and handles all communication with the AD server.

NSS (*Name Service Switch*)

NSS routines provide name service information. Naming service for both users and groups is provided by `nss_winbind`. This module directly interacts with the winbind daemon.

PAM (*Pluggable Authentication Modules*)

User authentication for AD users is done by the `pam_winbind` module. The creation of user homes for the AD users on the Linux client is handled by `pam_mkhome`. The `pam_winbind` module directly interacts with `winbindd`. To learn more about PAM in general, refer to Chapter 2, *Authentication with PAM* (page 17).

Applications that are PAM-aware, like the login routines and the GNOME and KDE display managers, interact with the PAM and NSS layer to authenticate against the Windows server. Applications supporting Kerberos authentication (such as file managers, Web browsers, or e-mail clients) use the Kerberos credential cache to access user's Kerberos tickets, making them part of the SSO framework.

5.2.1 Domain Join

During domain join, the server and the client establish a secure relation. On the client, the following tasks need to be performed to join the existing LDAP and Kerberos SSO environment provided by the Windows domain controller. The entire join process is handled by the YaST Domain Membership module, which can be run during installation or in the installed system:

- 1 The Windows domain controller providing both LDAP and KDC (Key Distribution Center) services is located.
- 2 A machine account for the joining client is created in the directory service.
- 3 An initial ticket granting ticket (TGT) is obtained for the client and stored in its local Kerberos credential cache. The client needs this TGT to get further tickets allowing it to contact other services, like contacting the directory server for LDAP queries.
- 4 NSS and PAM configurations are adjusted to enable the client to authenticate against the domain controller.

During client boot, the winbind daemon is started and retrieves the initial Kerberos ticket for the machine account. winbindd automatically refreshes the machine's ticket to keep it valid. To keep track of the current account policies, winbindd periodically queries the domain controller.

5.2.2 Domain Login and User Homes

The login managers of GNOME and KDE (GDM and KDM) have been extended to allow the handling of AD domain login. Users can choose to log into the primary domain the machine has joined or to one of the trusted domains with which the domain controller of the primary domain has established a trust relationship.

User authentication is mediated by a number of PAM modules as described in Section 5.2, “Background Information for Linux AD Support” (page 70). The `pam_winbind` module used to authenticate clients against Active Directory or NT4 domains is fully aware of Windows error conditions that might prohibit a user's login. The Windows error codes are translated into appropriate user-readable error messages that PAM gives at login through any of the supported methods (GDM, KDM, console, and SSH):

```
Password has expired
```

The user sees a message stating that the password has expired and needs to be changed. The system prompts for a new password and informs the user if the new password does not comply with corporate password policies (for example the password is too short, too simple, or already in the history). If a user's password change fails, the reason is shown and a new password prompt is given.

Account disabled

The user sees an error message stating that the account has been disabled and to contact the system administrator.

Account locked out

The user sees an error message stating that the account has been locked and to contact the system administrator.

Password has to be changed

The user can log in but receives a warning that the password needs to be changed soon. This warning is sent three days before that password expires. After expiration, the user cannot log in.

Invalid workstation

When a user is restricted to specific workstations and the current SUSE Linux Enterprise Server machine is not among them, a message appears that this user cannot log in from this workstation.

Invalid logon hours

When a user is only allowed to log in during working hours and tries to log in outside working hours, a message informs the user that logging in is not possible at that time.

Account expired

An administrator can set an expiration time for a specific user account. If that user tries to log in after expiration, the user gets a message that the account has expired and cannot be used to log in.

During a successful authentication, `pam_winbind` acquires a ticket granting ticket (TGT) from the Kerberos server of Active Directory and stores it in the user's credential cache. It also renews the TGT in the background, requiring no user interaction.

SUSE Linux Enterprise Server supports local home directories for AD users. If configured through YaST as described in Section 5.3, “Configuring a Linux Client for Active Directory” (page 76), user homes are created at the first login of a Windows (AD) user into the Linux client. These home directories look and feel entirely the same as standard Linux user home directories and work independently of the AD domain controller. Using a local user home, it is possible to access a user's data on this machine (even when the AD server is disconnected) as long as the Linux client has been configured to perform offline authentication.

5.2.3 Offline Service and Policy Support

Users in a corporate environment must have the ability to become roaming users (for example, to switch networks or even work disconnected for some time). To enable users to log in to a disconnected machine, extensive caching was integrated into the winbind daemon. The winbind daemon enforces password policies even in the offline state. It tracks the number of failed login attempts and reacts according to the policies configured in Active Directory. Offline support is disabled by default and must be explicitly enabled in the YaST Domain Membership module.

When the domain controller has become unavailable, the user can still access network resources (other than the AD server itself) with valid Kerberos tickets that have been acquired before losing the connection (as in Windows). Password changes cannot be processed unless the domain controller is online. While disconnected from the AD server, a user cannot access any data stored on this server. When a workstation has become disconnected from the network entirely and connects to the corporate network again later, SUSE Linux Enterprise Server acquires a new Kerberos ticket as soon as the user has locked and unlocked the desktop (for example, using a desktop screen saver).

5.3 Configuring a Linux Client for Active Directory

Before your client can join an AD domain, some adjustments must be made to your network setup to ensure the flawless interaction of client and server.

DNS

Configure your client machine to use a DNS server that can forward DNS requests to the AD DNS server. Alternatively, configure your machine to use the AD DNS server as the name service data source.

NTP

To succeed with Kerberos authentication, the client must have its time set accurately. It is highly recommended to use a central NTP time server for this purpose (this can be also the NTP server running on your Active Directory domain controller). If the clock skew between your Linux host and the domain controller exceeds a certain limit, Kerberos authentication fails and the client is logged in using the weaker NTLM (NT LAN Manager) authentication. For more details about using active directory for time synchronization, see Procedure 5.1, “Joining an AD Domain” (page 77).

DHCP

If your client uses dynamic network configuration with DHCP, configure DHCP to provide the same IP and hostname to the client. If possible, use static IP addresses.

Firewall

To browse your network neighborhood, either disable the firewall entirely or mark the interface used for browsing as part of the internal zone.

To change the firewall settings on your client, log in as `root` and start the YaST firewall module. Select *Interfaces*. Select your network interface from the list of interfaces and click *Change*. Select *Internal Zone* and apply your settings with *OK*. Leave the firewall settings with *Next > Finish*. To disable the firewall, just check the *Disable Firewall Automatic Starting* option, and leave the firewall module with *Next > Finish*.

AD Account

You cannot log in to an AD domain unless the AD administrator has provided you with a valid user account for that domain. Use the AD username and password to log in to the AD domain from your Linux client.

Join an existing AD domain during installation (or by later activating SMB user authentication with YaST in the installed system). The domain join during installation is covered in Section “User Authentication Method” (Chapter 6, *Installation with YaST, ↑Deployment Guide*).

NOTE

Currently only a domain administrator account, such as `Administrator`, can join SUSE Linux Enterprise Server into Active Directory.

To join an AD domain in a running system, proceed as follows:

Procedure 5.1 *Joining an AD Domain*

- 1 Log in as `root` and start YaST.
- 2 Start *Network Services > Windows Domain Membership*.
- 3 Enter the domain to join at *Domain or Workgroup* in the *Windows Domain Membership* screen (see Figure 5.2, “Determining Windows Domain Membership” (page 78)). If the DNS settings on your host are properly integrated with the Windows DNS server, enter the AD domain name in its DNS format (`mydomain.mycompany.com`). If you enter the short name of your domain (also known as the pre-Windows 2000 domain name), YaST must rely on NetBIOS name resolution instead of DNS to find the correct domain controller.

Figure 5.2 *Determining Windows Domain Membership*

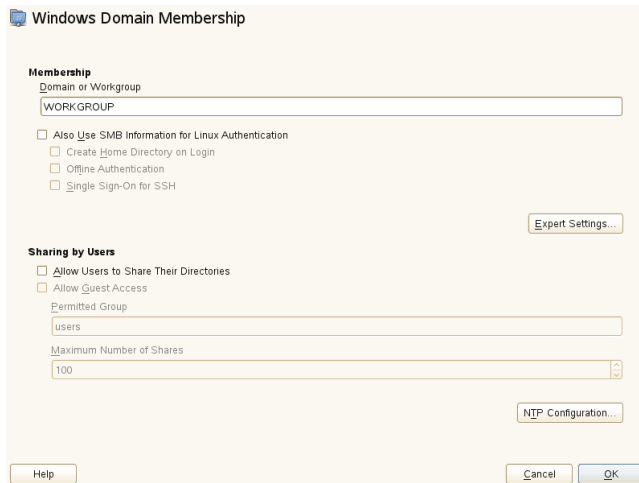

- 4 Check *Also Use SMB Information for Linux Authentication* to use the SMB source for Linux authentication.
- 5 Check *Create Home Directory on Login* to automatically create a local home directory for your AD user on the Linux machine.
- 6 Check *Offline Authentication* to allow your domain users to log in even if the AD server is temporarily unavailable, or if you do not have a network connection.
- 7 Select *Expert Settings*, if you want to change the UID and GID ranges for the Samba users and groups. Let DHCP retrieve the WINS server only if you need it. This is the case when some of your machines are resolved only by the WINS system.
- 8 Configure NTP time synchronization for your AD environment by selecting *NTP Configuration* and entering an appropriate server name or IP address. This step is obsolete if you have already entered the appropriate settings in the standalone YaST NTP configuration module.
- 9 Click *OK* and confirm the domain join when prompted for it.

- 10 Provide the password for the Windows administrator on the AD server and click *OK* (see Figure 5.3, “Providing Administrator Credentials” (page 79)).

Figure 5.3 *Providing Administrator Credentials*

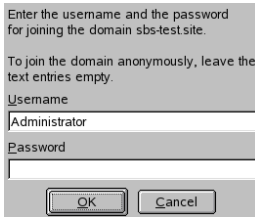

After you have joined the AD domain, you can log in to it from your workstation using the display manager of your desktop or the console.

5.4 Logging In to an AD Domain

Provided your machine has been configured to authenticate against Active Directory and you have a valid Windows user identity, you can log in to your machine using the AD credentials. Login is supported for both desktop environments (GNOME and KDE), the console, SSH, and any other PAM-aware application.

IMPORTANT: Offline Authentication

SUSE Linux Enterprise Server supports offline authentication, allowing you to remain logged in to your client machine even if the client machine is disconnected from the network.

5.4.1 GDM and KDM

To authenticate a GNOME client machine against an AD server, proceed as follows:

- 1 Select the domain.
- 2 Enter your Windows username and press Enter.
- 3 Enter your Windows password and press Enter.

To authenticate a KDE client machine against an AD server, proceed as follows:

- 1 Select the domain.
- 2 Enter your Windows username.
- 3 Enter your Windows password and press Enter.

If configured to do so, SUSE Linux Enterprise Server creates a user home directory on the local machine on the first login of each AD authenticated user. This allows you to benefit from the AD support of SUSE Linux Enterprise Server while still having a fully functional Linux machine at your disposal.

5.4.2 Console Login

As well as logging into the AD client machine using a graphical front-end, you can log in using the text-based console login or even remotely using SSH.

To log in to your AD client from a console, enter `DOMAIN\user` at the `login:` prompt and provide the password.

To remotely log in to your AD client machine using SSH, proceed as follows:

- 1 At the login prompt, enter:

```
ssh DOMAIN\user@hostname
```

The `\` domain and login delimiter is escaped with another `\` sign.

- 2 Provide the user's password.

5.5 Changing Passwords

SUSE Linux Enterprise Server has the ability to help a user choose a suitable new password that meets the corporate security policy. The underlying PAM module retrieves the current password policy settings from the domain controller, informing the user about the specific password quality requirements a user account typically has by means of a message on login. Like its Windows counterpart, SUSE Linux Enterprise Server presents a message describing:

- Password history settings
- Minimum password length requirements
- Minimum password age
- Password complexity

The password change process cannot succeed unless all requirements have been successfully met. Feedback about the password status is given both through the display managers and the console.

GDM and KDM provide feedback about password expiration and the prompt for new passwords in an interactive mode. To change passwords in the display managers, just provide the password information when prompted.

To change your Windows password, you can use the standard Linux utility, `passwd`, instead of having to manipulate this data on the server. To change your Windows password, proceed as follows:

- 1 Log in at the console.
- 2 Enter `passwd`.
- 3 Enter your current password when prompted.
- 4 Enter the new password.
- 5 Reenter the new password for confirmation. If your new password does not comply with the policies on the Windows server, this feedback is given to you and you are prompted for another password.

To change your Windows password from the GNOME desktop, proceed as follows:

- 1 Click the *Computer* icon on the left edge of the panel.
- 2 Select *Control Center*.
- 3 From the *Personal* section, select *About Me > Change Password*.
- 4 Enter your old password.
- 5 Enter and confirm the new password.
- 6 Leave the dialog with *Close* to apply your settings.

To change your Windows password from the KDE desktop, proceed as follows:

- 1 Select *Configure Desktop* from the main menu.
- 2 Select *About Me* from the *Personal* section.
- 3 Click *Password & User Account*.
- 4 Click *Change Password*.
- 5 Enter your current password.
- 6 Enter and confirm the new password and apply your settings with *OK*.
- 7 Leave the configuration dialog with *File > Quit*.

Network Authentication with Kerberos

An open network provides no means of ensuring that a workstation can identify its users properly, except through the usual password mechanisms. In common installations, the user must enter the password each time a service inside the network is accessed. Kerberos provides an authentication method with which a user registers once then is trusted in the complete network for the rest of the session. To have a secure network, the following requirements must be met:

- Have all users prove their identity for each desired service and make sure that no one can take the identity of someone else.
- Make sure that each network server also proves its identity. Otherwise an attacker might be able to impersonate the server and obtain sensitive information transmitted to the server. This concept is called *mutual authentication*, because the client authenticates to the server and vice versa.

Kerberos helps you meet these requirements by providing strongly encrypted authentication. The following shows how this is achieved. Only the basic principles of Kerberos are discussed here. For detailed technical instruction, refer to the documentation provided with your implementation of Kerberos.

6.1 Kerberos Terminology

The following glossary defines some Kerberos terminology.

credential

Users or clients need to present some kind of credentials that authorize them to request services. Kerberos knows two kinds of credentials—tickets and authenticators.

ticket

A ticket is a per-server credential used by a client to authenticate at a server from which it is requesting a service. It contains the name of the server, the client's name, the client's Internet address, a time stamp, a lifetime, and a random session key. All this data is encrypted using the server's key.

authenticator

Combined with the ticket, an authenticator is used to prove that the client presenting a ticket is really the one it claims to be. An authenticator is built using the client's name, the workstation's IP address, and the current workstation's time, all encrypted with the session key known only to the client and the relevant server. An authenticator can only be used once, unlike a ticket. A client can build an authenticator itself.

principal

A Kerberos principal is a unique entity (a user or service) to which it can assign a ticket. A principal consists of the following components:

- **Primary**—the first part of the principal, which can be the same as your username in the case of a user.
- **Instance**—some optional information characterizing the primary. This string is separated from the primary by a /.
- **Realm**—this specifies your Kerberos realm. Normally, your realm is your domain name in uppercase letters.

mutual authentication

Kerberos ensures that both client and server can be sure of each others identity. They share a session key, which they can use to communicate securely.

session key

Session keys are temporary private keys generated by Kerberos. They are known to the client and used to encrypt the communication between the client and the server for which it requested and received a ticket.

replay

Almost all messages sent in a network can be eavesdropped, stolen, and resent. In the Kerberos context, this would be most dangerous if an attacker manages to obtain your request for a service containing your ticket and authenticator. The attacker could then try to resend it (*replay*) to impersonate you. However, Kerberos implements several mechanisms to deal with this problem.

server or service

Service is used to refer to a specific action to perform. The process behind this action is referred to as a *server*.

6.2 How Kerberos Works

Kerberos is often called a third party trusted authentication service, which means all its clients trust Kerberos's judgment of another client's identity. Kerberos keeps a database of all its users and their private keys.

To ensure Kerberos is working correctly, run both the authentication and ticket-granting server on a dedicated machine. Make sure that only the administrator can access this machine physically and over the network. Reduce the (networking) services run on it to the absolute minimum—do not even run `sshd`.

6.2.1 First Contact

Your first contact with Kerberos is quite similar to any login procedure at a normal networking system. Enter your username. This piece of information and the name of the ticket-granting service are sent to the authentication server (Kerberos). If the authentication server knows you, it generates a random session key for further use between your client and the ticket-granting server. Now the authentication server prepares a ticket for the ticket-granting server. The ticket contains the following information—all encrypted with a session key only the authentication server and the ticket-granting server know:

- The names both of the client and the ticket-granting server
- The current time
- A lifetime assigned to this ticket
- The client's IP address
- The newly-generated session key

This ticket is then sent back to the client together with the session key, again in encrypted form, but this time the private key of the client is used. This private key is only known to Kerberos and the client, because it is derived from your user password. Now that the client has received this response, you are prompted for your password. This password is converted into the key that can decrypt the package sent by the authentication server. The package is “unwrapped” and password and key are erased from the workstation's memory. As long as the lifetime given to the ticket used to obtain other tickets does not expire, your workstation can prove your identity.

6.2.2 Requesting a Service

To request a service from any server in the network, the client application needs to prove its identity to the server. Therefore, the application generates an authenticator. An authenticator consists of the following components:

- The client's principal
- The client's IP address
- The current time
- A checksum (chosen by the client)

All this information is encrypted using the session key that the client has already received for this special server. The authenticator and the ticket for the server are sent to the server. The server uses its copy of the session key to decrypt the authenticator, which gives it all the information needed about the client requesting its service, to compare it to that contained in the ticket. The server checks if the ticket and the authenticator originate from the same client.

Without any security measures implemented on the server side, this stage of the process would be an ideal target for replay attacks. Someone could try to resend a request stolen off the net some time before. To prevent this, the server does not accept any request with a time stamp and ticket received previously. In addition to that, a request with a time stamp differing too much from the time the request is received is ignored.

6.2.3 Mutual Authentication

Kerberos authentication can be used in both directions. It is not only a question of the client being the one it claims to be. The server should also be able to authenticate itself to the client requesting its service. Therefore, it sends an authenticator itself. It adds one to the checksum it received in the client's authenticator and encrypts it with the session key, which is shared between it and the client. The client takes this response as a proof of the server's authenticity and they both start cooperating.

6.2.4 Ticket Granting—Contacting All Servers

Tickets are designed to be used for one server at a time. This implies that you have to get a new ticket each time you request another service. Kerberos implements a mechanism to obtain tickets for individual servers. This service is called the “ticket-granting service”. The ticket-granting service is a service (like any other service mentioned before) and uses the same access protocols that have already been outlined. Any time an application needs a ticket that has not already been requested, it contacts the ticket-granting server. This request consists of the following components:

- The requested principal
- The ticket-granting ticket
- An authenticator

Like any other server, the ticket-granting server now checks the ticket-granting ticket and the authenticator. If they are considered valid, the ticket-granting server builds a new session key to be used between the original client and the new server. Then the ticket for the new server is built, containing the following information:

- The client's principal
- The server's principal
- The current time
- The client's IP address
- The newly-generated session key

The new ticket is assigned a lifetime, which is the lesser of the remaining lifetime of the ticket-granting ticket and the default for the service. The client receives this ticket and the session key, which are sent by the ticket-granting service, but this time the answer is encrypted with the session key that came with the original ticket-granting ticket. The client can decrypt the response without requiring the user's password when a new service is contacted. Kerberos can thus acquire ticket after ticket for the client without bothering the user more than once at login time.

6.2.5 Compatibility to Windows 2000

Windows 2000 contains a Microsoft implementation of Kerberos 5. Because SUSE® Linux Enterprise Server uses the MIT implementation of Kerberos 5, find useful information and guidance in the MIT documentation. See Section 6.5, “For More Information” (page 110).

6.3 Users' View of Kerberos

Ideally, a user's one and only contact with Kerberos happens during login at the workstation. The login process includes obtaining a ticket-granting ticket. At logout, a user's Kerberos tickets are automatically destroyed, which makes it difficult for anyone else to impersonate this user. The automatic expiration of tickets can lead to a somewhat awkward situation when a user's login session lasts longer than the maximum lifespan given to the ticket-granting ticket (a reasonable setting is 10 hours). However, the user can get a new ticket-granting ticket by running `kinit`. Enter the password again and Kerberos obtains access to desired services without additional authentication. To get a list of all the tickets silently acquired for you by Kerberos, run `klist`.

Here is a short list of some applications that use Kerberos authentication. These applications can be found under `/usr/lib/mit/bin` or `/usr/lib/mit/sbin` after installing the package `krb5-apps-clients`. They all have the full functionality of their common UNIX and Linux brothers plus the additional bonus of transparent authentication managed by Kerberos:

- telnet, telnetd
- rlogin
- rsh, rcp, rshd
- ftp, ftpd
- ksu

You no longer have to enter your password for using these applications because Kerberos has already proven your identity. `ssh`, if compiled with Kerberos support, can even forward all the tickets acquired for one workstation to another one. If you use `ssh` to log in to another workstation, `ssh` makes sure that the encrypted contents of the tickets are adjusted to the new situation. Simply copying tickets between workstations is not sufficient because the ticket contains workstation-specific information (the IP address). XDM, GDM, and KDM offer Kerberos support, too. Read more about the Kerberos network applications in *Kerberos V5 UNIX User's Guide* at <http://web.mit.edu/kerberos>.

6.4 Installing and Administering Kerberos

A Kerberos environment consists of several different components. A key distribution center (KDC) holds the central database with all Kerberos-relevant data. All clients rely on the KDC for proper authentication across the network. Both the KDC and the clients need to be configured to match your setup:

General Preparations

Check your network setup and make sure it meets the minimum requirements outlined in Section 6.4.1, “Kerberos Network Topology” (page 90). Choose an appropriate realm for your Kerberos setup, see Section 6.4.2, “Choosing the Kerberos

Realms” (page 91). Carefully set up the machine that is to serve as the KDC and apply tight security, see Section 6.4.3, “Setting Up the KDC Hardware” (page 92). Set up a reliable time source in your network to make sure all tickets contain valid timestamps, see Section 6.4.4, “Configuring Time Synchronization” (page 93).

Basic Configuration

Configure the KDC and the clients, see Section 6.4.5, “Configuring the KDC” (page 94) and Section 6.4.6, “Configuring Kerberos Clients” (page 96). Enable remote administration for your Kerberos service, so you do not need physical access to your KDC machine, see Section 6.4.7, “Configuring Remote Kerberos Administration” (page 102). Create service principals for every service in your realm, see Section 6.4.8, “Creating Kerberos Service Principals” (page 104).

Enabling Kerberos Authentication

Various services in your network can make use of Kerberos. To add Kerberos password-checking to applications using PAM, proceed as outlined in Section 6.4.9, “Enabling PAM Support for Kerberos” (page 105). To configure SSH or LDAP with Kerberos authentication, proceed as outlined in Section 6.4.10, “Configuring SSH for Kerberos Authentication” (page 106) and Section 6.4.11, “Using LDAP and Kerberos” (page 107).

6.4.1 Kerberos Network Topology

Any Kerberos environment must meet the following requirements to be fully functional:

- Provide a DNS server for name resolution across your network, so clients and servers can locate each other. Refer to Chapter 21, *The Domain Name System* (↑*Administration Guide*) for information on DNS setup.
- Provide a time server in your network. Using exact time stamps is crucial to a Kerberos setup, because valid Kerberos tickets must contain correct time stamps. Refer to Chapter 20, *Time Synchronization with NTP* (↑*Administration Guide*) for information on NTP setup.
- Provide a key distribution center (KDC) as the center piece of the Kerberos architecture. It holds the Kerberos database. Use the tightest possible security policy on this machine to prevent any attacks on this machine compromising your entire infrastructure.
- Configure the client machines to use Kerberos authentication.

The following figure depicts a simple example network with just the minimum components needed to build a Kerberos infrastructure. Depending on the size and topology of your deployment, your setup may vary.

Figure 6.1 *Kerberos Network Topology*

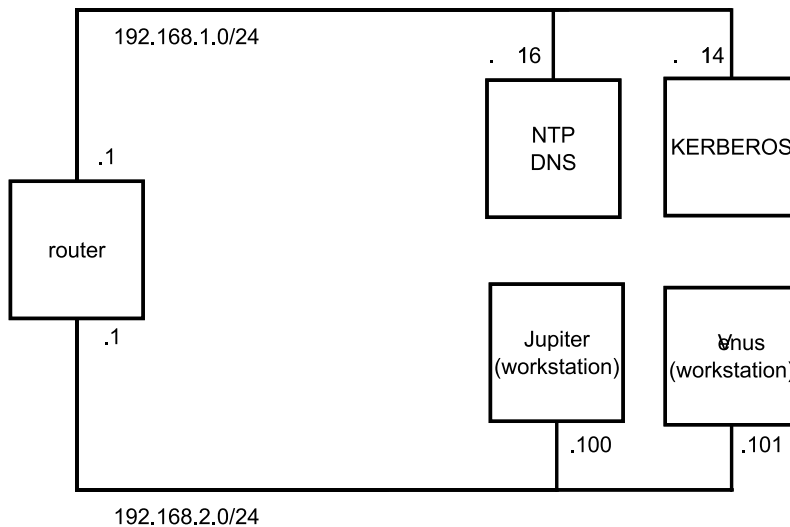

TIP: Configuring Subnet Routing

For a setup similar to the one in Figure 6.1, “Kerberos Network Topology” (page 91), configure routing between the two subnets (192.168.1.0/24 and 192.168.2.0/24). Refer to Section “Configuring Routing” (Chapter 18, *Basic Networking*, ↑*Administration Guide*) for more information on configuring routing with YaST.

6.4.2 Choosing the Kerberos Realms

The domain of a Kerberos installation is called a realm and is identified by a name, such as `EXAMPLE.COM` or simply `ACCOUNTING`. Kerberos is case-sensitive, so `example.com` is actually a different realm than `EXAMPLE.COM`. Use the case you prefer. It is common practice, however, to use uppercase realm names.

It is also a good idea to use your DNS domain name (or a subdomain, such as `ACCOUNTING.EXAMPLE.COM`). As shown below, your life as an administrator can be much easier if you configure your Kerberos clients to locate the KDC and other Kerberos services via DNS. To do so, it is helpful if your realm name is a subdomain of your DNS domain name.

Unlike the DNS name space, Kerberos is not hierarchical. You cannot set up a realm named `EXAMPLE.COM`, have two “subrealms” named `DEVELOPMENT` and `ACCOUNTING` underneath it, and expect the two subordinate realms to somehow inherit principals from `EXAMPLE.COM`. Instead, you would have three separate realms for which you would have to configure crossrealm authentication for users from one realm to interact with servers or other users from another realm.

For the sake of simplicity, assume you are setting up just one realm for your entire organization. For the remainder of this section, the realm name `EXAMPLE.COM` is used in all examples.

6.4.3 Setting Up the KDC Hardware

The first thing required to use Kerberos is a machine that acts as the key distribution center, or KDC for short. This machine holds the entire Kerberos user database with passwords and all information.

The KDC is the most important part of your security infrastructure—if someone breaks into it, all user accounts and all of your infrastructure protected by Kerberos is compromised. An attacker with access to the Kerberos database can impersonate any principal in the database. Tighten security for this machine as much as possible:

- 1 Put the server machine into a physically secured location, such as a locked server room to which only a very few people have access.
- 2 Do not run any network applications on it except the KDC. This includes servers and clients—for example, the KDC should not import any file systems via NFS or use DHCP to retrieve its network configuration.
- 3 Install a minimal system first then check the list of installed packages and remove any unneeded packages. This includes servers, such as `inetd`, `portmap`, and `cups`, as well as anything X-based. Even installing an SSH server should be considered a potential security risk.

4 No graphical login is provided on this machine as an X server is a potential security risk. Kerberos provides its own administration interface.

5 Configure `/etc/nsswitch.conf` to use only local files for user and group lookup. Change the lines for `passwd` and `group` to look like this:

```
passwd:      files
group:      files
```

Edit the `passwd`, `group`, and `shadow` files in `/etc` and remove the lines that start with a `+` character (these are for NIS lookups).

6 Disable all user accounts except `root`'s account by editing `/etc/shadow` and replacing the hashed passwords with `*` or `!` characters.

6.4.4 Configuring Time Synchronization

To use Kerberos successfully, make sure that all system clocks within your organization are synchronized within a certain range. This is important because Kerberos protects against replayed credentials. An attacker might be able to observe Kerberos credentials on the network and reuse them to attack the server. Kerberos employs several defenses to prevent this. One of them is that it puts time stamps into its tickets. A server receiving a ticket with a time stamp that differs from the current time rejects the ticket.

Kerberos allows a certain leeway when comparing time stamps. However, computer clocks can be very inaccurate in keeping time—it is not unheard of for PC clocks to lose or gain half an hour over the course of a week. For this reason, configure all hosts on the network to synchronize their clocks with a central time source.

A simple way to do so is by installing an NTP time server on one machine and having all clients synchronize their clocks with this server. Do this either by running an NTP daemon in client mode on all these machines or by running `ntpdate` once a day from all clients (this solution probably works for a small number of clients only). The KDC itself needs to be synchronized to the common time source as well. Because running an NTP daemon on this machine would be a security risk, it is probably a good idea to do this by running `ntpdate` via a cron entry. To configure your machine as an NTP client, proceed as outlined in Section “Configuring an NTP Client with YaST” (Chapter 20, *Time Synchronization with NTP*, ↑*Administration Guide*).

A different way to secure the time service and still use the NTP daemon is to attach a hardware reference clock to a dedicated NTP server as well as an additional hardware reference clock to the KDC.

It is also possible to adjust the maximum deviation Kerberos allows when checking time stamps. This value (called *clock skew*) can be set in the `krb5.conf` file as described in Section “Adjusting the Clock Skew” (page 102).

6.4.5 Configuring the KDC

This section covers the initial configuration and installation of the KDC, including the creation of an administrative principal. This procedure consists of several steps:

- 1 Install the RPMs** On a machine designated as the KDC, install special software packages. Use YaST to install the `krb5`, `krb5-server` and `krb5-client` packages.
- 2 Adjust the Configuration Files** The configuration files `/etc/krb5.conf` and `/var/lib/kerberos/krb5kdc/kdc.conf` must be adjusted for your scenario. These files contain all information on the KDC.
- 3 Create the Kerberos Database** Kerberos keeps a database of all principal identifiers and the secret keys of all principals that need to be authenticated. Refer to Section “Setting Up the Database” (page 95) for details.
- 4 Adjust the ACL Files: Add Administrators** The Kerberos database on the KDC can be managed remotely. To prevent unauthorized principals from tampering with the database, Kerberos uses access control lists. You must explicitly enable remote access for the administrator principal to enable him to manage the database. The Kerberos ACL file is located under `/var/lib/kerberos/krb5kdc/kadm5.acl`. Refer to Section 6.4.7, “Configuring Remote Kerberos Administration” (page 102) for details.
- 5 Adjust the Kerberos Database: Add Administrators** You need at least one administrative principal to run and administer Kerberos. This principal must be added before starting the KDC. Refer to Section “Creating a Principal” (page 96) for details.

6 Start the Kerberos Daemon Once the KDC software is installed and properly configured, start the Kerberos daemon to provide Kerberos service for your realm. Refer to Section “Starting the KDC” (page 96) for details.

7 Create a Principal for Yourself You need a principal for yourself. Refer to Section “Creating a Principal” (page 96) for details.

Setting Up the Database

Your next step is to initialize the database where Kerberos keeps all information about principals. Set up the database master key, which is used to protect the database from accidental disclosure (in particular when it is backed up to tape). The master key is derived from a pass phrase and is stored in a file called the stash file. This is so you do not need to enter the password every time the KDC is restarted. Make sure that you choose a good pass phrase, such as a sentence from a book opened to a random page.

When you make tape backups of the Kerberos database (`/var/lib/kerberos/krb5kdc/principal`), do not back up the stash file (which is in `/var/lib/kerberos/krb5kdc/.k5.EXAMPLE.COM`). Otherwise, everyone able to read the tape could also decrypt the database. Therefore, it is also a good idea to keep a copy of the pass phrase in a safe or some other secure location, because you need it to restore your database from backup tape after a crash.

To create the stash file and the database, run:

```
$> kdb5_util create -r EXAMPLE.COM -s
Initializing database '/var/lib/kerberos/krb5kdc/principal' for realm
'EXAMPLE.COM',
master key name 'K/M@EXAMPLE.COM'
You will be prompted for the database Master Password.
It is important that you NOT FORGET this password.
Enter KDC database master key: <= Type the master password.
Re-enter KDC database master key to verify: <= Type it again.
$>
```

To verify, use the list command:

```
$>kadmin.local
kadmin> listprincs
K/M@EXAMPLE.COM
kadmin/admin@EXAMPLE.COM
kadmin/changepw@EXAMPLE.COM
krbtgt/EXAMPLE.COM@EXAMPLE.COM
```

This shows that there are now a number of principals in the database. All of these are for internal use by Kerberos.

Creating a Principal

Next, create two Kerberos principals for yourself: one normal principal for your everyday work and one for administrative tasks relating to Kerberos. Assuming your login name is `newbie`, proceed as follows:

```
kadmin.local

kadmin> ank newbie
newbie@EXAMPLE.COM's Password: <type password here>
Verifying password: <re-type password here>
```

Next, create another principal named `newbie/admin` by typing `ank newbie/admin` at the `kadmin` prompt. The `admin` suffixed to your username is a *role*. Later, use this role when administering the Kerberos database. A user can have several roles for different purposes. Roles are basically completely different accounts with similar names.

Starting the KDC

Start the KDC daemon and the `kadmin` daemon. To start the daemons manually, enter `rckrb5kdc start` and `rckadmind start`. Also make sure that KDC and `kadmind` are started by default when the server machine is rebooted with the command `insserv krb5kdc` and `insserv kadmind`.

6.4.6 Configuring Kerberos Clients

Once the supporting infrastructure is in place (DNS, NTP) and the KDC has been properly configured and started, configure the clients machines. You can either use YaST to configure a Kerberos client or use one of the two manual approaches described below.

Configuring a Kerberos Client with YaST

Rather than manually editing all relevant configuration files when configuring a Kerberos client, let YaST do the job for you. You can either perform the client configuration during the installation of your machine or in the installed system:

- 1 Log in as `root` and select *Network Services > Kerberos Client*.
- 2 Select *Use Kerberos*.
- 3 To configure a DNS-based Kerberos client, proceed as follows:
 - 3a Confirm the *Basic Kerberos Settings* that are displayed.
 - 3b Click *Advanced Settings* to configure details on ticket-related issues, OpenSSH support, time synchronization, and extended PAM configurations.
- 4 To configure a static Kerberos client, proceed as follows:
 - 4a Set *Default Domain*, *Default Realm*, and *KDC Server Address* to the values that match your setup.
 - 4b Click *Advanced Settings* to configure details on ticket-related issues, OpenSSH support, time synchronization, and extended PAM configurations.

Figure 6.2 *YaST: Basic Configuration of a Kerberos Client*

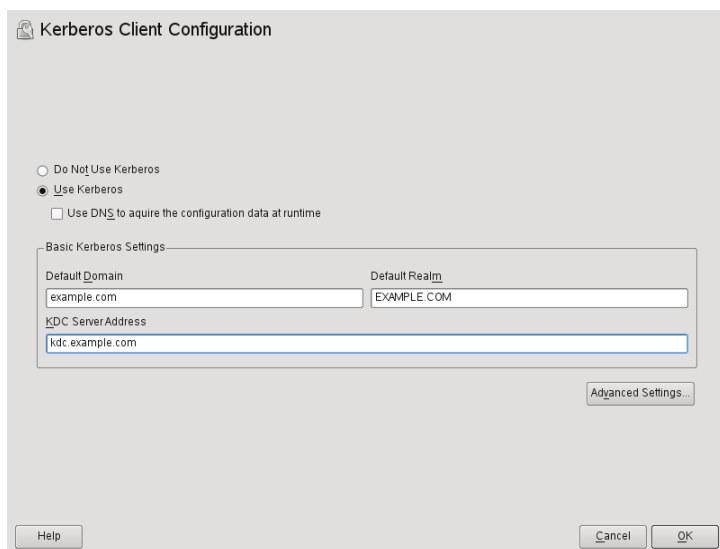

To configure ticket-related options in the *Advanced Settings* dialog, choose from the following options:

- Specify the *Default Ticket Lifetime* and the *Default Renewable Lifetime* in days, hours, or minutes (using the units of measurement *d*, *h*, and *m*, with no blank space between the value and the unit).
- To forward your complete identity (to use your tickets on other hosts), select *Forwardable*.
- Enable the transfer of certain tickets by selecting *Proxiabile*.
- Enable Kerberos authentication support for your OpenSSH client by selecting the corresponding check box. The client then uses Kerberos tickets to authenticate with the SSH server.
- Exclude a range of user accounts from using Kerberos authentication by providing a value for the *Minimum UID* that a user of this feature must have. For instance, you may want to exclude the system administrator (`root`).
- Use *Clock Skew* to set a value for the allowable difference between the time stamps and your host's system time.
- To keep the system time in sync with an NTP server, you can also set up the host as an NTP client by selecting *NTP Configuration*, which opens the YaST NTP client dialog that is described in Section “Configuring an NTP Client with YaST” (Chapter 20, *Time Synchronization with NTP*, ↑*Administration Guide*). After finishing the configuration, YaST performs all the necessary changes and the Kerberos client is ready for use.

Figure 6.3 *YaST: Advanced Configuration of a Kerberos Client*

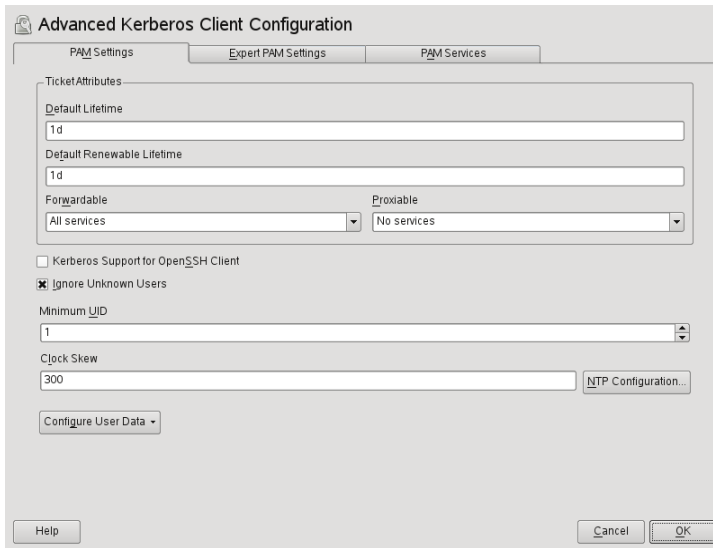

For more information about the configuration of *Expert PAM Settings* and *PAM Services* tabs, see the official documentation referenced in Section 6.5, “For More Information” (page 110) and the manual page `man 5 krb5.conf`.

Manually Configuring Kerberos Clients

When configuring Kerberos, there are basically two approaches you can take—static configuration in the `/etc/krb5.conf` file or dynamic configuration with DNS. With DNS configuration, Kerberos applications try to locate the KDC services using DNS records. With static configuration, add the hostnames of your KDC server to `krb5.conf` (and update the file whenever you move the KDC or reconfigure your realm in other ways).

DNS-based configuration is generally a lot more flexible and the amount of configuration work per machine is a lot less. However, it requires that your realm name is either the same as your DNS domain or a subdomain of it. Configuring Kerberos via DNS also creates a minor security issue—an attacker can seriously disrupt your infrastructure through your DNS (by shooting down the name server, spoofing DNS records, etc.). However, this amounts to a denial of service at worst. A similar scenario applies to the

static configuration case unless you enter IP addresses in `krb5.conf` instead of hostnames.

Static Configuration

One way to configure Kerberos is to edit the configuration file `/etc/krb5.conf`. The file installed by default contains various sample entries. Erase all of these entries before starting. `krb5.conf` is made up of several sections, each introduced by the section name included in brackets like `[this]`.

To configure your Kerberos clients, add the following stanza to `krb5.conf` (where `kdc.example.com` is the hostname of the KDC):

```
[libdefaults]
    default_realm = EXAMPLE.COM

[realms]
    EXAMPLE.COM = {
        kdc = kdc.example.com
        admin_server = kdc.example.com
    }
```

The `default_realm` line sets the default realm for Kerberos applications. If you have several realms, just add additional statements to the `[realms]` section.

Also add a statement to this file that tells applications how to map hostnames to a realm. For example, when connecting to a remote host, the Kerberos library needs to know in which realm this host is located. This must be configured in the `[domain_realms]` section:

```
[domain_realm]
    .example.com = EXAMPLE.COM
    www.foobar.com = EXAMPLE.COM
```

This tells the library that all hosts in the `example.com` DNS domains are in the `EXAMPLE.COM` Kerberos realm. In addition, one external host named `www.foobar.com` should also be considered a member of the `EXAMPLE.COM` realm.

DNS-Based Configuration

DNS-based Kerberos configuration makes heavy use of SRV records. See *(RFC2052) A DNS RR for specifying the location of services* at <http://www.ietf.org>. These

records are not supported in earlier implementations of the BIND name server. At least BIND version 8 is required for this.

The name of an SRV record, as far as Kerberos is concerned, is always in the format `_service._proto.realm`, where `realm` is the Kerberos realm. Domain names in DNS are case insensitive, so case-sensitive Kerberos realms would break when using this configuration method. `_service` is a service name (different names are used when trying to contact the KDC or the password service, for example). `_proto` can be either `_udp` or `_tcp`, but not all services support both protocols.

The data portion of SRV resource records consists of a priority value, a weight, a port number, and a hostname. The priority defines the order in which hosts should be tried (lower values indicate a higher priority). The weight value is there to support some sort of load balancing among servers of equal priority. You probably do not need any of this, so it is okay to set these to zero.

MIT Kerberos currently looks up the following names when looking for services:

`_kerberos`

This defines the location of the KDC daemon (the authentication and ticket granting server). Typical records look like this:

```
_kerberos._udp.EXAMPLE.COM. IN SRV 0 0 88 kdc.example.com.  
_kerberos._tcp.EXAMPLE.COM. IN SRV 0 0 88 kdc.example.com.
```

`_kerberos-adm`

This describes the location of the remote administration service. Typical records look like this:

```
_kerberos-adm._tcp.EXAMPLE.COM. IN SRV 0 0 749 kdc.example.com.
```

Because `kadmind` does not support UDP, there should be no `_udp` record.

As with the static configuration file, there is a mechanism to inform clients that a specific host is in the `EXAMPLE.COM` realm, even if it is not part of the `example.com` DNS domain. This can be done by attaching a TXT record to `_kerberos.hostname`, as shown here:

```
_kerberos.www.foofoo.com. IN TXT "EXAMPLE.COM"
```

Adjusting the Clock Skew

The *clock skew* is the tolerance for accepting tickets with time stamps that do not exactly match the host's system clock. Usually, the clock skew is set to 300 seconds (five minutes). This means a ticket can have a time stamp somewhere between five minutes behind and five minutes ahead of the server's clock.

When using NTP to synchronize all hosts, you can reduce this value to about one minute. The clock skew value can be set in `/etc/krb5.conf` like this:

```
[libdefaults]
    clockskew = 120
```

6.4.7 Configuring Remote Kerberos Administration

To be able to add and remove principals from the Kerberos database without accessing the KDC's console directly, tell the Kerberos administration server which principals are allowed to do what. Do this by editing the file `/var/lib/kerberos/krb5kdc/kadm5.acl`. The ACL (access control list) file allows you to specify privileges with a precise degree of control. For details, refer to the manual page with `man 8 kadmind`.

For now, just grant yourself the privilege to administer the database by putting the following line into the file:

```
newbie/admin *
```

Replace the username `newbie` with your own. Restart `kadmind` for the change to take effect.

You should now be able to perform Kerberos administration tasks remotely using the `kadmin` tool. First, obtain a ticket for your admin role and use that ticket when connecting to the `kadmin` server:

```
kadmin -p newbie/admin
Authenticating as principal newbie/admin@EXAMPLE.COM with password.
Password for newbie/admin@EXAMPLE.COM:
kadmin: getprincs
current privileges: GET ADD MODIFY DELETE
kadmin:
```

Using the `getprivs` command, verify which privileges you have. The list shown above is the full set of privileges.

As an example, modify the principal `newbie`:

```
kadmin -p newbie/admin
Authenticating as principal newbie/admin@EXAMPLE.COM with password.
Password for newbie/admin@EXAMPLE.COM:

kadmin: getprinc newbie
Principal: newbie@EXAMPLE.COM
Expiration date: [never]
Last password change: Wed Jan 12 17:28:46 CET 2005
Password expiration date: [none]
Maximum ticket life: 0 days 10:00:00
Maximum renewable life: 7 days 00:00:00
Last modified: Wed Jan 12 17:47:17 CET 2005 (admin/admin@EXAMPLE.COM)
Last successful authentication: [never]
Last failed authentication: [never]
Failed password attempts: 0
Number of keys: 2
Key: vno 1, Triple DES cbc mode with HMAC/sha1, no salt
Key: vno 1, DES cbc mode with CRC-32, no salt
Attributes:
Policy: [none]

kadmin: modify_principal -maxlife "8 hours" newbie
Principal "newbie@EXAMPLE.COM" modified.
kadmin: getprinc joe
Principal: newbie@EXAMPLE.COM
Expiration date: [never]
Last password change: Wed Jan 12 17:28:46 CET 2005
Password expiration date: [none]
Maximum ticket life: 0 days 08:00:00
Maximum renewable life: 7 days 00:00:00
Last modified: Wed Jan 12 17:59:49 CET 2005 (newbie/admin@EXAMPLE.COM)
Last successful authentication: [never]
Last failed authentication: [never]
Failed password attempts: 0
Number of keys: 2
Key: vno 1, Triple DES cbc mode with HMAC/sha1, no salt
Key: vno 1, DES cbc mode with CRC-32, no salt
Attributes:
Policy: [none]
kadmin:
```

This changes the maximum ticket life time to eight hours. For more information about the `kadmin` command and the options available, refer to <http://web.mit.edu/kerberos/www/krb5-1.4/krb5-1.4/doc/krb5-admin.html#Kadmin%20Options> or look at `man 8 kadmin`.

6.4.8 Creating Kerberos Service Principals

So far, only user credentials have been discussed. However, Kerberos-compatible services usually need to authenticate themselves to the client user, too. Therefore, special service principals must be present in the Kerberos database for each service offered in the realm. For example, if `ldap.example.com` offers an LDAP service, you need a service principal, `ldap/ldap.example.com@EXAMPLE.COM`, to authenticate this service to all clients.

The naming convention for service principals is `service/hostname@REALM`, where `hostname` is the host's fully qualified hostname.

Valid service descriptors are:

Service Descriptor	Service
<code>host</code>	Telnet, RSH, SSH
<code>nfs</code>	NFSv4 (with Kerberos support)
<code>HTTP</code>	HTTP (with Kerberos authentication)
<code>imap</code>	IMAP
<code>pop</code>	POP3
<code>ldap</code>	LDAP

Service principals are similar to user principals, but have significant differences. The main difference between a user principal and a service principal is that the key of the former is protected by a password—when a user obtains a ticket-granting ticket from the KDC, he needs to type his password so Kerberos can decrypt the ticket. It would be quite inconvenient for the system administrator if he had to obtain new tickets for the SSH daemon every eight hours or so.

Instead, the key required to decrypt the initial ticket for the service principal is extracted by the administrator from the KDC only once and stored in a local file called the *keytab*.

Services such as the SSH daemon read this key and use it to obtain new tickets automatically, when needed. The default keytab file resides in `/etc/krb5.keytab`.

To create a host service principal for `jupiter.example.com` enter the following commands during your `kadmin` session:

```
kadmin -p newbie/admin
Authenticating as principal newbie/admin@EXAMPLE.COM with password.
Password for newbie/admin@EXAMPLE.COM:
kadmin: addprinc -randkey host/jupiter.example.com
WARNING: no policy specified for host/jupiter.example.com@EXAMPLE.COM;
defaulting to no policy
Principal "host/jupiter.example.com@EXAMPLE.COM" created.
```

Instead of setting a password for the new principal, the `-randkey` flag tells `kadmin` to generate a random key. This is used here because no user interaction is wanted for this principal. It is a server account for the machine.

Finally, extract the key and store it in the local keytab file `/etc/krb5.keytab`. This file is owned by the superuser, so you must be `root` to execute the next command in the `kadmin` shell:

```
kadmin: ktadd host/jupiter.example.com
Entry for principal host/jupiter.example.com with kvno 3, encryption type
Triple
DES cbc mode with HMAC/shal added to keytab WRFILE:/etc/krb5.keytab.
Entry for principal host/jupiter.example.com with kvno 3, encryption type DES
cbc mode with CRC-32 added to keytab WRFILE:/etc/krb5.keytab.
kadmin:
```

When completed, make sure that you destroy the admin ticket obtained with `kinit` above with `kdestroy`.

6.4.9 Enabling PAM Support for Kerberos

SUSE® Linux Enterprise Server comes with a PAM module named `pam_krb5`, which supports Kerberos login and password update. This module can be used by applications such as console login, `su`, and graphical login applications like KDM (where the user presents a password and would like the authenticating application to obtain an initial Kerberos ticket on his behalf). To configure PAM support for Kerberos, use the following command:

```
pam-config --add --krb5
```

The above command adds the `pam_krb5` module to the existing PAM configuration files and makes sure it is called in the right order. To make precise adjustments to the way in which `pam_krb5` is used, edit the file `/etc/krb5.conf` and add default applications to `pam`. For details, refer to the manual page with `man 5 pam_krb5`.

The `pam_krb5` module was specifically not designed for network services that accept Kerberos tickets as part of user authentication. This is an entirely different matter, and is discussed below.

6.4.10 Configuring SSH for Kerberos Authentication

OpenSSH supports Kerberos authentication in both protocol version 1 and 2. In version 1, there are special protocol messages to transmit Kerberos tickets. Version 2 does not use Kerberos directly anymore, but relies on GSSAPI, the General Security Services API. This is a programming interface that is not specific to Kerberos—it was designed to hide the peculiarities of the underlying authentication system, be it Kerberos, a public-key authentication system like SPKM, or others. The included GSSAPI library supports only Kerberos, however.

To use `sshd` with Kerberos authentication, edit `/etc/ssh/sshd_config` and set the following options:

```
# These are for protocol version 1
#
# KerberosAuthentication yes
# KerberosTicketCleanup yes

# These are for version 2 - better to use this
GSSAPIAuthentication yes
GSSAPICleanupCredentials yes
```

Then restart your SSH daemon using `rcsshd restart`.

To use Kerberos authentication with protocol version 2, enable it on the client side as well. Do this either in the systemwide configuration file `/etc/ssh/ssh_config` or on a per-user level by editing `~/.ssh/config`. In both cases, add the option `GSSAPIAuthentication yes`.

You should now be able to connect using Kerberos authentication. Use `klist` to verify that you have a valid ticket then connect to the SSH server. To force SSH protocol version 1, specify the `-1` option on the command line.

TIP: Additional Information

The file `/usr/share/doc/packages/openssh/README.kerberos` discusses the interaction of OpenSSH and Kerberos in more detail.

6.4.11 Using LDAP and Kerberos

When using Kerberos, one way to distribute the user information (such as user ID, groups, and home directory) in your local network is to use LDAP. This requires a strong authentication mechanism that prevents packet spoofing and other attacks. One solution is to use Kerberos for LDAP communication, too.

OpenLDAP implements most authentication flavors through SASL, the simple authentication session layer. SASL is basically a network protocol designed for authentication. The SASL implementation is `cyrus-sasl`, which supports a number of different authentication flavors. Kerberos authentication is performed through GSSAPI (General Security Services API). By default, the SASL plug-in for GSSAPI is not installed. Install it manually with `rpm -ivh cyrus-sasl-gssapi-*.rpm`.

To enable Kerberos to bind to the OpenLDAP server, create a principal `ldap/ldap.example.com` and add that to the keytab.

By default, the LDAP server `slapd` runs as user and group `ldap`, while the keytab file is readable by `root` only. Therefore, either change the LDAP configuration so the server runs as `root` or make the keytab file readable by the group `ldap`. The latter is done automatically by the OpenLDAP start script (`/etc/init.d/ldap`) if the keytab file has been specified in the `OPENLDAP_KRB5_KEYTAB` variable in `/etc/sysconfig/openldap` and the `OPENLDAP_CHOWN_DIRS` variable is set to `yes`, which is the default setting. If `OPENLDAP_KRB5_KEYTAB` is left empty, the default keytab under `/etc/krb5.keytab` is used and you must adjust the privileges yourself as described below.

To run `slapd` as `root`, edit `/etc/sysconfig/openldap`. Disable the `OPENLDAP_USER` and `OPENLDAP_GROUP` variables by putting a comment character in front of them.

To make the keytab file readable by group LDAP, execute

```
chgrp ldap /etc/krb5.keytab  
chmod 640 /etc/krb5.keytab
```

A third (and maybe the best) solution is to tell OpenLDAP to use a special keytab file. To do this, start `kadmin`, and enter the following command after you have added the principal `ldap/ldap.example.com`:

```
ktadd -k /etc/openldap/ldap.keytab ldap/ldap.example.com@EXAMPLE.COM
```

Then in the shell run:

```
chown ldap.ldap /etc/openldap/ldap.keytab  
chmod 600 /etc/openldap/ldap.keytab
```

To tell OpenLDAP to use a different keytab file, change the following variable in `/etc/sysconfig/openldap`:

```
OPENLDAP_KRB5_KEYTAB="/etc/openldap/ldap.keytab"
```

Finally, restart the LDAP server using `rcldap restart`.

Using Kerberos Authentication with LDAP

You should now be able to automatically use tools such as `ldapsearch` with Kerberos authentication.

```
ldapsearch -b ou=people,dc=example,dc=com '(uid=newbie)'  
  
SASL/GSSAPI authentication started  
SASL SSF: 56  
SASL installing layers  
[...]  
  
# newbie, people, example.com  
dn: uid=newbie,ou=people,dc=example,dc=com  
uid: newbie  
cn: Olaf Kirch  
[...]
```

As you can see, `ldapsearch` prints a message that it started GSSAPI authentication. The next message is very cryptic, but it shows that the *security strength factor* (SSF for short) is 56 (The value 56 is somewhat arbitrary. Most likely it was chosen because this is the number of bits in a DES encryption key). What this tells you is that GSSAPI authentication was successful and that encryption is being used to protect integrity and provide confidentiality for the LDAP connection.

In Kerberos, authentication is always mutual. This means that not only have you authenticated yourself to the LDAP server, but also the LDAP server has authenticated itself to you. In particular, this means communication is with the desired LDAP server, rather than some bogus service set up by an attacker.

Kerberos Authentication and LDAP Access Control

Now, allow each user to modify the login shell attribute of their LDAP user record. Assuming you have a schema where the LDAP entry of user `joe` is located at `uid=joe,ou=people,dc=example,dc=com`, set up the following access controls in `/etc/openldap/slapd.conf`:

```
# This is required for things to work _at all_
access to dn.base="" by * read
# Let each user change their login shell
access to dn="*,ou=people,dc=example,dc=com" attrs=loginShell
    by self write
# Every user can read everything
access to *
    by users read
```

The second statement gives authenticated users write access to the `loginShell` attribute of their own LDAP entry. The third statement gives all authenticated users read access to the entire LDAP directory.

There is one minor piece of the puzzle missing—how the LDAP server can find out that the Kerberos user `joe@EXAMPLE.COM` corresponds to the LDAP distinguished name `uid=joe,ou=people,dc=example,dc=com`. This sort of mapping must be configured manually using the `saslExpr` directive. In this example, add the following to `slapd.conf`:

```
authz-regexp
    uid=(.*),cn=GSSAPI,cn=auth
    uid=$1,ou=people,dc=example,dc=com
```

To understand how this works, you need to know that when SASL authenticates a user, OpenLDAP forms a distinguished name from the name given to it by SASL (such as `joe`) and the name of the SASL flavor (`GSSAPI`). The result would be `uid=joe,cn=GSSAPI,cn=auth`.

If a `authz-regexp` has been configured, it checks the DN formed from the SASL information using the first argument as a regular expression. If this regular expression matches, the name is replaced with the second argument of the `authz-regexp` statement. The placeholder `$1` is replaced with the substring matched by the `(.*)` expression.

More complicated match expressions are possible. If you have a more complicated directory structure or a schema in which the username is not part of the DN, you can even use search expressions to map the SASL DN to the user DN.

6.5 For More Information

The official site of the MIT Kerberos is <http://web.mit.edu/kerberos>. There, find links to any other relevant resource concerning Kerberos, including Kerberos installation, user, and administration guides.

The paper at <ftp://athena-dist.mit.edu/pub/kerberos/doc/usenix.PS> gives quite an extensive insight to the basic principles of Kerberos, without being too difficult to read. It also provides a lot of opportunities for further investigation and reading about Kerberos.

The official Kerberos FAQ is available at <http://www.nrl.navy.mil/CCS/people/kenh/kerberos-faq.html>. The book *Kerberos—A Network Authentication System* by Brian Tung (ISBN 0-201-37924-4) offers extensive information.

Using the Fingerprint Reader

If your system includes a fingerprint reader, you can use biometric authentication in addition to standard authentication via login and password. After registering their fingerprint, users can log in to the system either by swiping a finger on the fingerprint reader or by typing in a password. SUSE® Linux Enterprise Server supports most available fingerprint readers. For a list of supported devices, please refer to http://reactivated.net/fprint/wiki/Supported_devices.

If the hardware check detects the fingerprint reader integrated with your laptop (or connected to your system), the packages `libfprint`, `pam_fp`, and `yast2-fingerprint-reader` are automatically installed.

Currently, only one fingerprint per user can be registered. The user's fingerprint data is stored to `/home/login/.fprint/`.

7.1 Supported Applications and Actions

The PAM module `pam_fp` supports fingerprint authentication for the following applications and actions (although you may not be prompted to swipe your finger in all cases):

- Logging in to GDM/KDM or a login shell
- Unlocking your screen on the GNOME/KDE desktop

- Starting YaST and the YaST modules
- Starting an application with `root` permission: `sudo` or `gnomesu`
- Changing to a different user identity with `su` or `su - username`

NOTE: Fingerprint Reader Devices and Encrypted Home Directories

If you want to use a fingerprint reader device, you must not use encrypted home directories (see Chapter 12, *Managing Users with YaST* ([↑Deployment Guide](#)) for more information). Otherwise logging in will fail, because decrypting during login is not possible in combination with an active fingerprint reader device.

7.2 Managing Fingerprints with YaST

Procedure 7.1 Enabling Fingerprint Authentication

You can only use biometric authentication if PAM is configured accordingly. Usually, this is done automatically during installation of the packages when the hardware check detects a supported fingerprint reader. If not, manually enable the fingerprint support in YaST as follows:

- 1 Start YaST and select *Hardware > Fingerprint Reader*.
- 2 In the configuration dialog, activate *Use Fingerprint Reader* and click *Finish* to save the changes and close the dialog.

Now you can register a fingerprint for various users.

Procedure 7.2 Registering a Fingerprint

- 1 In YaST, click *Security and Users > User Management* to open the *User and Group Administration* dialog. A list of users or groups in the system is displayed.
- 2 Select the user for whom you want to register a fingerprint and click *Edit*.
- 3 On the *Plug-Ins* tab, select the fingerprint entry and click *Launch* to open the *Fingerprint Configuration* dialog.

- 4 YaST prompts the user to swipe his finger until three readable fingerprints have been gathered.



- 5 After the fingerprint has been acquired successfully, click *Accept* to close the *Fingerprint Configuration* dialog and the dialog for the user.
- 6 If you also want to use fingerprint authentication for starting YaST or the YaST modules, you need to register a fingerprint for `root`, too.

To do so, set the filter in the *User and Group Administration* dialog to *System Users*, select the `root` entry and register a fingerprint for `root` as described above.

- 7 After you have registered fingerprints for the desired users, click *Finish* to close the administration dialog and to save the changes.

As soon as the user's fingerprint has been successfully registered, the user can choose to authenticate with either fingerprint or password for the actions and applications listed in Section 7.1, "Supported Applications and Actions" (page 111).

Currently, YaST does not offer verification or removal of fingerprints, but you remove fingerprints by deleting the directory `/home/login/.fprint`.

For more technical details, refer to <http://reactivated.net/fprint/>.

Part II. Local Security

Configuring Security Settings with YaST

8

The YaST module *Local Security* offers a central clearinghouse to configure security-related settings for SUSE Linux Enterprise Server. Use it to configure security aspects such as settings for the login procedure and for password creation, for boot permissions, user creation or for default file permissions. Launch it from the YaST Control Center by *Security and Users > Local Security*. The *Local Security* dialog always starts with the *Security Overview*, and other configuration dialogs are available from the right pane.

8.1 Security Overview

The *Security Overview* displays a comprehensive list of the most important security settings for your system. The security status of each entry in the list is clearly visible. A green check mark indicates a secure setting while a red cross indicates an entry as being insecure. Clicking on *Help* presents an overview of the setting and information on how to make it secure. To change a setting, click on the corresponding link in the Status column. Depending on the setting, the following entries are available:

Enable/Disable

Clicking on this entry will toggle the status of the setting to either enabled or disabled.

Configure

Clicking on this entry will launch another YaST module for configuration. You will return to the Security Overview when leaving the module.

Unknown

A setting's status is set to unknown when the associated service is not installed. Such a setting does not represent a potential security risk.

Figure 8.1 YaST Local Security - Security Overview

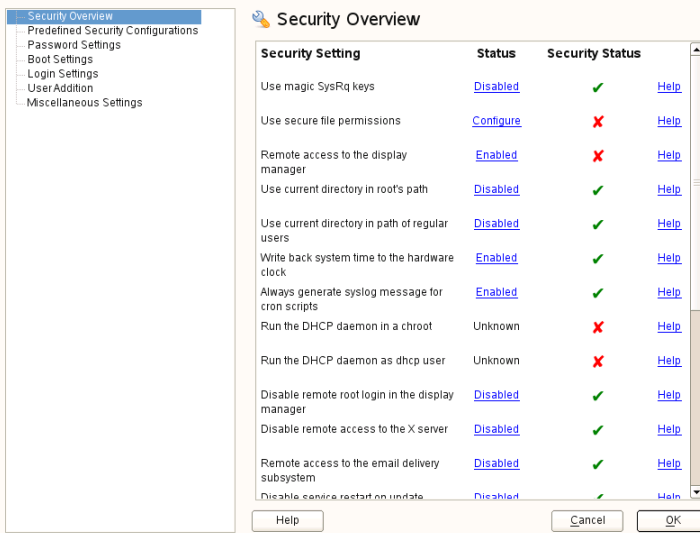

8.2 Predefined Security Configurations

SUSE Linux Enterprise Server comes with three predefined sets of security configurations. These configurations affect all the settings available in the *Local Security* module. Each configuration can be modified to your needs using the dialogs available from the right pane. Choose between the following sets:

Home Workstation

This setting is designed for a computer that has no network connection at all (including a connection to the Internet). It provides the least secure configuration of the predefined settings.

Networked Workstation

A configuration for a workstation with any kind of network connection (including a connection to the Internet).

Network Server

Security settings designed for a machine providing network services such as a web server, file server, name server, etc. This set provides the most secure configuration of the predefined settings.

Custom Settings

A pre-selected *Custom Settings* (when opening the *Predefined Security Configurations* dialog) indicates that one of the predefined sets has been modified. Actively choosing this option does not change the current configuration - you will have to change it using the *Security Overview*.

8.3 Password Settings

Passwords that are easy to guess are a major security issue. The *Password Settings* dialog provides the means to ensure that only secure passwords can be used.

Check New Passwords

By activating this option, a warning will be issued if new passwords appear in a dictionary, or if they are proper names (proper nouns).

Test for Complicated Passwords

When this option is checked, any new password is checked that it consists of a mixture of characters, digits and special characters. If it fails to pass this test, a warning is issued upon the entering of the new password.

Number of Passwords to Remember

When password expiration is activated, this setting stores the given number of a user's previous passwords, preventing their reuse.

Password Encryption Method

Choose a password encryption algorithm. Normally there is no need to change the default (Blowfish).

Minimum Acceptable Password Length

If the user chooses a password with a length shorter than specified here, a warning will be issued.

Password Age

Activate password expiration by specifying a minimum and a maximum time limit (in days). By setting the minimum age to a value greater than 0 days, you can prevent users from immediately changing their passwords again (and in doing so circumventing the password expiration). Use the values 0 and 99999 to deactivate password expiration.

Days Before Password Expires Warning

When a password expires, the user receives a warning in advance. Specify the number of days prior to the expiration date that the warning should be issued.

8.4 Boot Settings

Configure which users will be able to shutdown the machine via the graphical login manager in this dialog. You can also specify how Ctrl + Alt + Del will be interpreted.

8.5 Login Settings

This dialog lets you configure security-related login settings:

Delay after Incorrect Login Attempt

In order to make it difficult to guess a user's password by repeatedly logging in, it is recommended to delay the display of the login prompt that follows an incorrect login. Specify the value in seconds. Make sure that users who have mistyped their passwords do not need to wait too long.

Record Successful Login Attempts

With this option turned on, the last successful login attempt is recorded in `/var/log/lastlog` and displayed when logging in. This data is also used by the command `finger`.

NOTE

Please note that logging to `/var/log/wtmp` is not affected by this option. This file collects login dates, login times and reboot dates. The content of `/var/log/wtmp` can be displayed by using the command `last`.

Allow Remote Graphical Login

When checked, the graphical login manager (e.g. gdm or kdm) can be accessed from the network. This is a potential security risk.

8.6 User Addition

Set minimum and maximum values for user and group IDs. These default settings would rarely need to be changed.

8.7 Miscellaneous Settings

Other security settings that don't fit the above-mentioned categories are listed here:

File Permissions

SUSE Linux Enterprise Server comes with three predefined sets of file permissions for system files. These permission sets define whether a regular user may read log files or start certain programs. *Easy* file permissions are suitable for standalone machines. This settings allows regular users, for example, to read most system files. See the file `/etc/permissions.easy` for the complete configuration. The *Secure* file permissions are designed for multi-user machines with network access. A thorough explanation of these settings can be found in `/etc/permissions.secure`. The *Paranoid* settings are the most restrictive ones and should be used with care. See `/etc/permissions.secure` for more information.

User Launching updatedb

The program `updatedb` scans the system and creates a database of all file locations which can be queried with the command `locate`. When `updatedb` is run as user `nobody`, only world-readable files will be added to the database. When run as user `root`, almost all files (except the ones `root` is not allowed to read) will be added.

Current Directory in root's Path / Current Directory in Path of Regular Users

Whenever a program is called without specifying the full path to the executable, the system looks in the user's search path (defined by the variable `$PATH`) for the executable. By default the current directory is not added to the search path. This setting ensures that, for example, `/bin/ls` and not the trojan horse `/current directory/ls` is executed when entering `ls`. In order to start a program in the current directory the command must be prefixed with `./`. When activating these options, the current directory (`.`) is appended to the search path. It is recommended you not change the default.

Enable Magic SysRq Keys

The magic SysRq key is a keycombo that enables you to have some control over the system even when it has crashed. The complete documentation can be found at `/usr/src/linux/Documentation/sysrq.txt` (requires installation of the package `kernel-source`).

PolicyKit

PolicyKit is an application framework that acts as a negotiator between the unprivileged user session and the privileged system context. Whenever a process from the user session tries to carry out an action in the system context, PolicyKit is queried. Based on its configuration—specified in a so-called “policy”—the answer could be “yes”, “no”, or `needs authentication`. Unlike classical privilege authorization programs such as `sudo`, PolicyKit does not grant `root` permissions to an entire process, following the “least privilege” concept.

9.1 Available Policies and Supported Applications

At the moment, not all applications requiring privileges make use of PolicyKit. In the following the most important policies available on SUSE® Linux Enterprise Server are listed.

PulseAudio

Set scheduling priorities for the PulseAudio daemon

CUPS

Add, remove, edit, enable or disable printers

GNOME

- Modify system and mandatory values with GConf
- Change the system time

libvirt

- Manage and modify local virtualized systems

PolicyKit

- Read and change privileges for other users
- Modify defaults

System

- Wake on LAN
- Mount or unmount fixed, hotpluggable and encrypted devices
- Eject and decrypt removable media
- Enable or disable WLAN
- Enable or disable Bluetooth
- Device access
- Stop, suspend, hibernate and restart the system
- Undock a docking station

YaST

- Register product
- Change the system time and language

9.2 Authorization Types

Every time a PolicyKit-enabled process carries out a privileged operation, PolicyKit is asked whether this process is entitled to do so. The answer PolicyKit gives depends on the policy defined for this process. It can be “yes”, “no”, or “authentication needed”. By default, a policy contains “implicit” privileges, which automatically apply to all users. It is also possible to specify “explicit” privileges which apply to a specific user.

9.2.1 Implicit Privileges

Implicit privileges can be defined for any, active, and inactive sessions. An active session is the one in which you are currently working. It becomes inactive when you switch to another console for example. When setting implicit privileges to “no”, no user is authorized, whereas “yes” authorizes all users. However, in most cases it is useful to demand authentication.

A user can either authorize by authenticating as `root` or by authenticating as self. Both authentication methods exist in four variants:

Authentication

The user always has to authenticate

One Shot Authentication

The authentication is bound to the instance of the program currently running. Once the program is restarted, the user is required to authenticate again.

Keep Session Authentication

The authentication dialog box offers a check button *Remember authorization for this session*. If checked, the authentication is valid until the user logs out.

Keep Indefinitely Authentication

The authentication dialog box offers a check button *Remember authorization*. If checked, the user has to authenticate only once.

9.2.2 Explicit Privileges

Explicit privileges can be granted to specific users. They can either be granted without limitations, or, when using constraints, limited to an active session and/or a local console.

It is not only possible to grant privileges to a user, a user can also be blocked. Blocked users will not be able to carry out an action requiring authorization, even though the default implicit policy allows authorization by authentication.

9.3 Modifying and Setting Privileges

To modify implicit privileges or to set explicit ones, you can either use the graphical *Authorizations* tool available with GNOME, use the command line tools shipped with PolicyKit, or modify the configuration files. While the GUI and the command line tools are a good solution for making temporary changes, editing the configuration files should be the preferred way to make permanent changes.

9.3.1 Using the Graphical *Authorizations* Tool

Start the Authorizations tool either via the GNOME main menu by selecting *More Applications > Tools > Authorizations* or by pressing Alt + F2 and entering `polkit-gnome-authorization`.

TIP: Using the Authorizations tool in non-GNOME environments

Authorizations is a GNOME tool and therefore not installed when the GNOME desktop environment is not installed. In this case you need to install the package `PolicyKit-gnome` in order to use the tool.

Figure 9.1 *The Authorizations Tool*

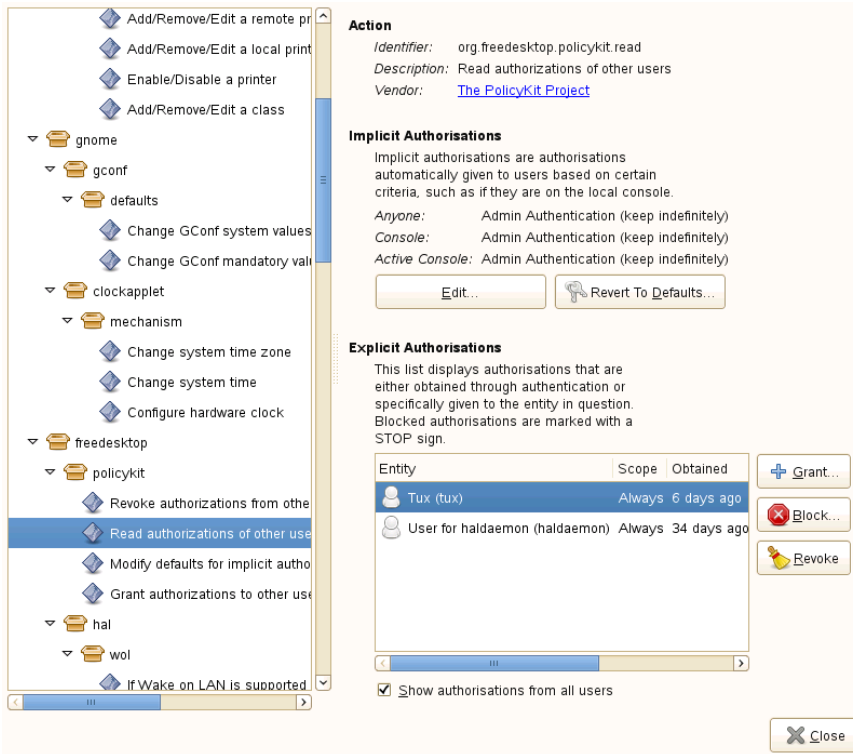

The Authorizations window is divided into two parts. The left side shows all policies available in a tree view, while the right side displays details for the policy selected and offers means to change it.

Action

Lists details of the chosen policy. The *Identifier* is the unique string used by PolicyKit to identify the policy. *Description* explains the purpose of the policy and *Vendor* displays a link to the organization that has issued this policy.

Implicit Authorizations

Change the privileges by clicking *Edit* and choosing an authorization type explained in Section 9.2.1, “Implicit Privileges” (page 125). Click *Revert To Defaults* to restore the system defaults.

Explicit Authorizations

In this section you can *Grant* privileges to existing users or *Block* users. In both cases, choose a user and a *Constraint*. Users with a UID of less than 1000 are only shown when *Show System Users* is checked. To delete an authorization, choose it from the list and click *Revoke*.

NOTE: Restrictions of the *Revert to Defaults* function on SUSE Linux Enterprise Server

When using *Revert to Defaults*, the Authorization tool always operates on the upstream defaults, so it is not possible to list or restore the defaults shipped with SUSE Linux Enterprise Server. Refer to Section 9.3.4, “Restoring the Default Privileges” (page 132) for further information.

9.3.2 Using the Command Line Tools

PolicyKit comes with two command line tools for changing implicit privileges and for assigning explicit privileges. Each existing policy has got a speaking, unique name with which it can be identified and which is used with the command line tools. List all available policies with the command `polkit-action`.

`polkit-action`

List and modify implicit privileges. Using this command you can also reset all policies to the default value. When invoked with no parameters, The command `polkit-action` shows a list of all policies. See `man 1 polkit-action` for more information.

`polkit-auth`

Inspect, grant, block and revoke explicit privileges. To print a list of explicit privileges for a specific user, use the command `polkit-auth`
`--explicit-detail --user USER` where `USER` has to be replaced by a valid username. If the `--user` option is left out, privileges for the user executing the command are shown. See `man 1 polkit-auth` for more information.

NOTE: Restrictions of `polkit-action` on SUSE Linux Enterprise Server

Using the option `--show-overrides`, `polkit-action` lists all policies that differ from the default values. With `--reset-defaults action` one can

reset the privileges for a given action to the defaults. However, `polkit-action` always operates on the upstream defaults, so it is not possible to list or restore the defaults shipped with SUSE Linux Enterprise Server. Refer to Section 9.3.4, “Restoring the Default Privileges” (page 132) for further information.

9.3.3 Modifying Configuration Files

Adjusting privileges by modifying configuration files is useful when you want to deploy the same set of policies to different machines, for example to the computers of a specific team. It is possible to change implicit as well as explicit privileges by modifying configuration files.

Modifying Configuration Files for Implicit Privileges

SUSE Linux Enterprise Server ships with two sets of default authorizations located in `/etc/polkit-default-privs.standard` and `/etc/polkit-default-privs.restrictive`. The `.standard` file defines privileges suitable for most desktop systems. The `.restrictive` set of privileges is designed for machines administrated centrally. It is active by default. Activate it by setting `POLKIT_DEFAULT_PRIVS` to `restrictive` in `/etc/sysconfig/security` and run `set_polkit_default_privs` as root afterwards. Do not modify these two files.

In order to define your custom set of privileges, use `/etc/polkit-default-privs.local`. Privileges defined here will always take precedence over the ones defined in the other configuration files. To define a privilege, add a line for each policy with the following format:

```
<privilege
    name>          <any
    session>:<inactive
    session>:<active
    session>
```

For a list of all privilege names available, run the command `polkit-action`. The following values are valid for the session parameters:

yes

grant privilege

no

block

auth_self

user needs to authenticate with own password every time the privilege is requested

auth_self_keep_session

user needs to authenticate with own password once per session, privilege is granted for the whole session

auth_self_keep_always

user needs to authenticate with own password once, privilege is granted for the current and for future sessions

auth_admin

user needs to authenticate with `root` password every time the privilege is requested

auth_admin_keep_session

user needs to authenticate with `root` password once per session, privilege is granted for the whole session

auth_admin_keep_always

user needs to authenticate with `root` password once, privilege is granted for the current and for future sessions

Run `set_polkit_default_privs` to activate your settings.

Modifying Configuration Files for Explicit Privileges

Explicit privileges can be set in `/etc/PolicyKit/PolicyKit.conf`. This configuration file is written in XML using the PolicyKit DTD. The file that is shipped with SUSE Linux Enterprise Server already contains the necessary headers and the root element `<config>`. Place your edits inside the `<config>` tags.

`match`

Specify an action or a user. `match` knows two attributes, `user` and `action`, but only a single attribute is allowed. Use nested `match` statements to combine attributes. POSIX Extended Regular Expressions are allowed as attribute values.

`user=USER`

Specify one or more login names. Separate multiple names by the “|” symbol.

`action=policy`

Specify a policy by its unique identifier. To get a list of all available policy identifiers use the command `polkit-action`.

`return`

Specify the answer PolicyKit will return. Takes a single attribute, `result=value` with one of the values listed under Section “Modifying Configuration Files for Implicit Privileges” (page 129).

`define_admin_auth`

Specify users or groups allowed to authorize with their own password where normally the `root` password would be required. Takes the attributes `user=USER` or `group=GROUP`, but only one may be used at a time. Multiple attribute values must be separated by “|”, Extended POSIX Regular Expressions are not supported. Applies to all policies when used at the top level, or to specific policies when used within `<match>` statements.

Example 9.1 An example `/etc/PolicyKit/PolicyKit.conf` file

```
<?xml version="1.0" encoding="UTF-8"?>
<!DOCTYPE pkconfig PUBLIC "-//freedesktop//DTD PolicyKit Configuration 1.0//EN"
"http://hal.freedesktop.org/releases/PolicyKit/1.0/config.dtd">❶
<config version="0.1">❷
  <match action="org.freedesktop.packagekit.system-update">❸
    <match user="tux">
      <return result="yes"/>
    </match>
  </match>
  <match action="org.freedesktop.policykit.*">❹
    <match user="tux|wilber">
      <return result="no"/>
    </match>
  </match>
  <define_admin_auth group="administrators"/>❺
</config>
```

- ❶ The first three lines of the config file are the XML header. These lines are already present in the template file, leave them untouched.
- ❷ The XML root element must always be present. The attribute `version` is mandatory, currently the only valid value is `0.1`. Already present in the template file.
- ❸ A statement granting the user `tux` the privilege to update packages via `PackageKit` without having to authorize.
- ❹ Withdraw privileges for all `PolicyKit` related policies from the users `tux` and `wilber`.
- ❺ This statement allows all members of the group `administrators` to authenticate with their own password whenever authentication with the `root` password would be required. Since this statement is not nested within constraining match statements, it applies to all policies.

9.3.4 Restoring the Default Privileges

Each application supporting `PolicyKit` comes with a default set of implicit policies defined by the application's developers, the so-called “upstream defaults”. The privileges defined by the upstream defaults are not necessarily the ones that are activated by default on `SUSE Linux Enterprise Server`. `SUSE Linux Enterprise Server` comes with a predefined set of privileges (see Section “Modifying Configuration Files for Implicit Privi-

leges” (page 129) for more information) that is activated by default, overriding the upstream defaults.

Since the Authorization tool and the PolicyKit command line utilities always operate on the upstream defaults, SUSE Linux Enterprise Server comes with the command-line tool `set_polkit_default_privs` that resets privileges to the values defined in `/etc/polkit-default-privs.*`. However, `set_polkit_default_privs` will only reset policies that are set to the upstream defaults. To reset all policies to the upstream defaults first and then apply the SUSE Linux Enterprise Server defaults, run the following command:

```
rm -f /var/lib/PolicyKit-public/* && set_polkit_default_privs
```

IMPORTANT: /etc/polkit-default-privs.local

In order to apply the SUSE Linux Enterprise Server defaults, make sure `/etc/polkit-default-privs.local` does not contain any overrides, otherwise these will be applied on top of the defaults when running `set_polkit_default_privs`.

Access Control Lists in Linux

POSIX ACLs (access control lists) can be used as an expansion of the traditional permission concept for file system objects. With ACLs, permissions can be defined more flexibly than with the traditional permission concept.

The term *POSIX ACL* suggests that this is a true POSIX (*portable operating system interface*) standard. The respective draft standards POSIX 1003.1e and POSIX 1003.2c have been withdrawn for several reasons. Nevertheless, ACLs (as found on many systems belonging to the UNIX family) are based on these drafts and the implementation of file system ACLs (as described in this chapter) follows these two standards, as well.

10.1 Traditional File Permissions

Find detailed information about the traditional file permissions in the GNU Coreutils Info page, Node *File permissions* (`info coreutils "File permissions"`). More advanced features are the `setuid`, `setgid`, and sticky bit.

10.1.1 The `setuid` Bit

In certain situations, the access permissions may be too restrictive. Therefore, Linux has additional settings that enable the temporary change of the current user and group identity for a specific action. For example, the `passwd` program normally requires root permissions to access `/etc/passwd`. This file contains some important information, like the home directories of users and user and group IDs. Thus, a normal user would not be able to change `passwd`, because it would be too dangerous to grant all

users direct access to this file. A possible solution to this problem is the *setuid* mechanism. *setuid* (set user ID) is a special file attribute that instructs the system to execute programs marked accordingly under a specific user ID. Consider the `passwd` command:

```
-rwsr-xr-x 1 root shadow 80036 2004-10-02 11:08 /usr/bin/passwd
```

You can see the `s` that denotes that the *setuid* bit is set for the user permission. By means of the *setuid* bit, all users starting the `passwd` command execute it as `root`.

10.1.2 The *setgid* Bit

The *setuid* bit applies to users. However, there is also an equivalent property for groups: the *setgid* bit. A program for which this bit was set runs under the group ID under which it was saved, no matter which user starts it. Therefore, in a directory with the *setgid* bit, all newly created files and subdirectories are assigned to the group to which the directory belongs. Consider the following example directory:

```
drwxrws--- 2 tux archive 48 Nov 19 17:12 backup
```

You can see the `s` that denotes that the *setgid* bit is set for the group permission. The owner of the directory and members of the group `archive` may access this directory. Users that are not members of this group are “mapped” to the respective group. The effective group ID of all written files will be `archive`. For example, a backup program that runs with the group ID `archive` is able to access this directory even without root privileges.

10.1.3 The Sticky Bit

There is also the *sticky bit*. It makes a difference whether it belongs to an executable program or a directory. If it belongs to a program, a file marked in this way is loaded to RAM to avoid needing to get it from the hard disk each time it is used. This attribute is used rarely, because modern hard disks are fast enough. If this bit is assigned to a directory, it prevents users from deleting each other's files. Typical examples include the `/tmp` and `/var/tmp` directories:

```
drwxrwxrwt 2 root root 1160 2002-11-19 17:15 /tmp
```

10.2 Advantages of ACLs

Traditionally, three permission sets are defined for each file object on a Linux system. These sets include the read (*r*), write (*w*), and execute (*x*) permissions for each of three types of users—the file owner, the group, and other users. In addition to that, it is possible to set the *set user id*, the *set group id*, and the *sticky* bit. This lean concept is fully adequate for most practical cases. However, for more complex scenarios or advanced applications, system administrators formerly had to use a number of workarounds to circumvent the limitations of the traditional permission concept.

ACLs can be used as an extension of the traditional file permission concept. They allow the assignment of permissions to individual users or groups even if these do not correspond to the original owner or the owning group. Access control lists are a feature of the Linux kernel and are currently supported by ReiserFS, Ext2, Ext3, JFS, and XFS. Using ACLs, complex scenarios can be realized without implementing complex permission models on the application level.

The advantages of ACLs are evident if you want to replace a Windows server with a Linux server. Some of the connected workstations may continue to run under Windows even after the migration. The Linux system offers file and print services to the Windows clients with Samba. With Samba supporting access control lists, user permissions can be configured both on the Linux server and in Windows with a graphical user interface (only Windows NT and later). With *winbindd*, part of the samba suite, it is even possible to assign permissions to users only existing in the Windows domain without any account on the Linux server.

10.3 Definitions

User Class

The conventional POSIX permission concept uses three *classes* of users for assigning permissions in the file system: the owner, the owning group, and other users. Three permission bits can be set for each user class, giving permission to read (*r*), write (*w*), and execute (*x*).

ACL

The user and group access permissions for all kinds of file system objects (files and directories) are determined by means of ACLs.

Default ACL

Default ACLs can only be applied to directories. They determine the permissions a file system object inherits from its parent directory when it is created.

ACL Entry

Each ACL consists of a set of ACL entries. An ACL entry contains a type, a qualifier for the user or group to which the entry refers, and a set of permissions. For some entry types, the qualifier for the group or users is undefined.

10.4 Handling ACLs

Table 10.1, “ACL Entry Types” (page 139) summarizes the six possible types of ACL entries, each defining permissions for a user or a group of users. The *owner* entry defines the permissions of the user owning the file or directory. The *owning group* entry defines the permissions of the file's owning group. The superuser can change the owner or owning group with `chown` or `chgrp`, in which case the owner and owning group entries refer to the new owner and owning group. Each *named user* entry defines the permissions of the user specified in the entry's qualifier field. Each *named group* entry defines the permissions of the group specified in the entry's qualifier field. Only the named user and named group entries have a qualifier field that is not empty. The *other* entry defines the permissions of all other users.

The *mask* entry further limits the permissions granted by named user, named group, and owning group entries by defining which of the permissions in those entries are effective and which are masked. If permissions exist in one of the mentioned entries as well as in the mask, they are effective. Permissions contained only in the mask or only in the actual entry are not effective—meaning the permissions are not granted. All permissions defined in the owner and owning group entries are always effective. The example in Table 10.2, “Masking Access Permissions” (page 139) demonstrates this mechanism.

There are two basic classes of ACLs: A *minimum* ACL contains only the entries for the types owner, owning group, and other, which correspond to the conventional permission bits for files and directories. An *extended* ACL goes beyond this. It must contain a mask entry and may contain several entries of the named user and named group types.

Table 10.1 *ACL Entry Types*

Type	Text Form
owner	user::rwx
named user	user:name:rwx
owning group	group::rwx
named group	group:name:rwx
mask	mask::rwx
other	other::rwx

Table 10.2 *Masking Access Permissions*

Entry Type	Text Form	Permissions
named user	user:geeko:r-x	r-x
mask	mask::rw-	rw-
	effective permissions:	r--

10.4.1 ACL Entries and File Mode Permission Bits

Figure 10.1, “Minimum ACL: ACL Entries Compared to Permission Bits” (page 140) and Figure 10.2, “Extended ACL: ACL Entries Compared to Permission Bits” (page 140) illustrate the two cases of a minimum ACL and an extended ACL. The figures are structured in three blocks—the left block shows the type specifications of the ACL entries, the center block displays an example ACL, and the right block shows the respective permission bits according to the conventional permission concept (for example, as displayed by `ls -l`). In both cases, the *owner class* permissions are mapped to the

ACL entry owner. *Other class* permissions are mapped to the respective ACL entry. However, the mapping of the *group class* permissions is different in the two cases.

Figure 10.1 *Minimum ACL: ACL Entries Compared to Permission Bits*

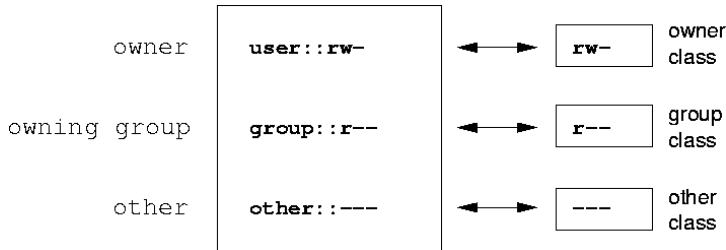

In the case of a minimum ACL—without mask—the group class permissions are mapped to the ACL entry owning group. This is shown in Figure 10.1, “Minimum ACL: ACL Entries Compared to Permission Bits” (page 140). In the case of an extended ACL—with mask—the group class permissions are mapped to the mask entry. This is shown in Figure 10.2, “Extended ACL: ACL Entries Compared to Permission Bits” (page 140).

Figure 10.2 *Extended ACL: ACL Entries Compared to Permission Bits*

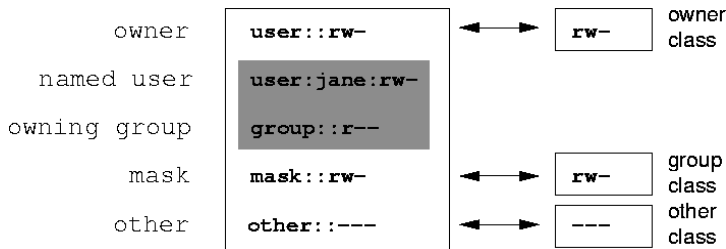

This mapping approach ensures the smooth interaction of applications, regardless of whether they have ACL support. The access permissions that were assigned by means of the permission bits represent the upper limit for all other “fine adjustments” made with an ACL. Changes made to the permission bits are reflected by the ACL and vice versa.

10.4.2 A Directory with an ACL

With `getfacl` and `setfacl` on the command line, you can access ACLs. The usage of these commands is demonstrated in the following example.

Before creating the directory, use the `umask` command to define which access permissions should be masked each time a file object is created. The command `umask 027` sets the default permissions by giving the owner the full range of permissions (0), denying the group write access (2), and giving other users no permissions at all (7). `umask` actually masks the corresponding permission bits or turns them off. For details, consult the `umask` man page.

`mkdir mydir` creates the `mydir` directory with the default permissions as set by `umask`. Use `ls -dl mydir` to check whether all permissions were assigned correctly. The output for this example is:

```
drwxr-x--- ... tux project3 ... mydir
```

With `getfacl mydir`, check the initial state of the ACL. This gives information like:

```
# file: mydir
# owner: tux
# group: project3
user::rwx
group::r-x
other::---
```

The first three output lines display the name, owner, and owning group of the directory. The next three lines contain the three ACL entries owner, owning group, and other. In fact, in the case of this minimum ACL, the `getfacl` command does not produce any information you could not have obtained with `ls`.

Modify the ACL to assign read, write, and execute permissions to an additional user `geeko` and an additional group `ascots` with:

```
setfacl -m user:geeko:rwx,group:ascots:rwx mydir
```

The option `-m` prompts `setfacl` to modify the existing ACL. The following argument indicates the ACL entries to modify (multiple entries are separated by commas). The final part specifies the name of the directory to which these modifications should be applied. Use the `getfacl` command to take a look at the resulting ACL.

```

# file: mydir
# owner: tux
# group: project3
user::rwx
user:geeko:rwx
group::r-x
group:mascots:rwx
mask::rwx
other:---

```

In addition to the entries initiated for the user `geeko` and the group `mascots`, a mask entry has been generated. This mask entry is set automatically so that all permissions are effective. `setfacl` automatically adapts existing mask entries to the settings modified, unless you deactivate this feature with `-n`. `mask` defines the maximum effective access permissions for all entries in the group class. This includes named user, named group, and owning group. The group class permission bits displayed by `ls -dl mydir` now correspond to the mask entry.

```
drwxrwx---+ ... tux project3 ... mydir
```

The first column of the output contains an additional `+` to indicate that there is an *extended* ACL for this item.

According to the output of the `ls` command, the permissions for the mask entry include write access. Traditionally, such permission bits would mean that the owning group (here `project3`) also has write access to the directory `mydir`. However, the effective access permissions for the owning group correspond to the overlapping portion of the permissions defined for the owning group and for the mask—which is `r-x` in our example (see Table 10.2, “Masking Access Permissions” (page 139)). As far as the effective permissions of the owning group in this example are concerned, nothing has changed even after the addition of the ACL entries.

Edit the mask entry with `setfacl` or `chmod`. For example, use `chmod g-w mydir`. `ls -dl mydir` then shows:

```
drwxr-x---+ ... tux project3 ... mydir
```

`getfacl mydir` provides the following output:

```

# file: mydir
# owner: tux
# group: project3
user::rwx
user:geeko:rwx          # effective: r-x
group::r-x

```

```
group:mascots:rwx      # effective: r-x
mask::r-x
other::---
```

After executing the `chmod` command to remove the write permission from the group class bits, the output of the `ls` command is sufficient to see that the mask bits must have changed accordingly: write permission is again limited to the owner of `mydir`. The output of the `getfacl` confirms this. This output includes a comment for all those entries in which the effective permission bits do not correspond to the original permissions, because they are filtered according to the mask entry. The original permissions can be restored at any time with `chmod g+w mydir`.

10.4.3 A Directory with a Default ACL

Directories can have a default ACL, which is a special kind of ACL defining the access permissions that objects in the directory inherit when they are created. A default ACL affects both subdirectories and files.

Effects of a Default ACL

There are two ways in which the permissions of a directory's default ACL are passed to the files and subdirectories:

- A subdirectory inherits the default ACL of the parent directory both as its default ACL and as an ACL.
- A file inherits the default ACL as its ACL.

All system calls that create file system objects use a `mode` parameter that defines the access permissions for the newly created file system object. If the parent directory does not have a default ACL, the permission bits as defined by the `umask` are subtracted from the permissions as passed by the `mode` parameter, with the result being assigned to the new object. If a default ACL exists for the parent directory, the permission bits assigned to the new object correspond to the overlapping portion of the permissions of the `mode` parameter and those that are defined in the default ACL. The `umask` is disregarded in this case.

Application of Default ACLs

The following three examples show the main operations for directories and default ACLs:

1. Add a default ACL to the existing directory `mydir` with:

```
setfacl -d -m group:mascots:r-x mydir
```

The option `-d` of the `setfacl` command prompts `setfacl` to perform the following modifications (option `-m`) in the default ACL.

Take a closer look at the result of this command:

```
getfacl mydir

# file: mydir
# owner: tux
# group: project3
user::rwx
user:geeko:rwx
group::r-x
group:mascots:rwx
mask::rwx
other:---
default:user::rwx
default:group::r-x
default:group:mascots:r-x
default:mask::r-x
default:other:---
```

`getfacl` returns both the ACL and the default ACL. The default ACL is formed by all lines that start with `default`. Although you merely executed the `setfacl` command with an entry for the `mascots` group for the default ACL, `setfacl` automatically copied all other entries from the ACL to create a valid default ACL. Default ACLs do not have an immediate effect on access permissions. They only come into play when file system objects are created. These new objects inherit permissions only from the default ACL of their parent directory.

2. In the next example, use `mkdir` to create a subdirectory in `mydir`, which inherits the default ACL.

```
mkdir mydir/mysubdir

getfacl mydir/mysubdir

# file: mydir/mysubdir
# owner: tux
# group: project3
user::rwx
group::r-x
group:mascots:r-x
mask::r-x
other:---
default:user::rwx
default:group::r-x
default:group:mascots:r-x
default:mask::r-x
default:other:---
```

As expected, the newly-created subdirectory `mysubdir` has the permissions from the default ACL of the parent directory. The ACL of `mysubdir` is an exact reflection of the default ACL of `mydir`. The default ACL that this directory will hand down to its subordinate objects is also the same.

3. Use `touch` to create a file in the `mydir` directory, for example, `touch mydir/myfile`. `ls -l mydir/myfile` then shows:

```
-rw-r-----+ ... tux project3 ... mydir/myfile
```

The output of `getfacl mydir/myfile` is:

```
# file: mydir/myfile
# owner: tux
# group: project3
user::rw-
group::r-x          # effective:r--
group:mascots:r-x  # effective:r--
mask::r--
other:---
```

`touch` uses a mode with the value `0666` when creating new files, which means that the files are created with read and write permissions for all user classes, provided no other restrictions exist in `umask` or in the default ACL (see Section “Effects of a Default ACL” (page 143)). In effect, this means that all access permissions not contained in the mode value are removed from the respective ACL entries.

Although no permissions were removed from the ACL entry of the group class, the mask entry was modified to mask permissions not set in `mode`.

This approach ensures the smooth interaction of applications (such as compilers) with ACLs. You can create files with restricted access permissions and subsequently mark them as executable. The `mask` mechanism guarantees that the right users and groups can execute them as desired.

10.4.4 The ACL Check Algorithm

A check algorithm is applied before any process or application is granted access to an ACL-protected file system object. As a basic rule, the ACL entries are examined in the following sequence: owner, named user, owning group or named group, and other. The access is handled in accordance with the entry that best suits the process. Permissions do not accumulate.

Things are more complicated if a process belongs to more than one group and would potentially suit several group entries. An entry is randomly selected from the suitable entries with the required permissions. It is irrelevant which of the entries triggers the final result “access granted”. Likewise, if none of the suitable group entries contain the required permissions, a randomly selected entry triggers the final result “access denied”.

10.5 ACL Support in Applications

ACLs can be used to implement very complex permission scenarios that meet the requirements of modern applications. The traditional permission concept and ACLs can be combined in a smart manner. The basic file commands (`cp`, `mv`, `ls`, etc.) support ACLs, as do Samba and Konqueror.

Unfortunately, many editors and file managers still lack ACL support. When copying files with Emacs, for instance, the ACLs of these files are lost. When modifying files with an editor, the ACLs of files are sometimes preserved and sometimes not, depending on the backup mode of the editor used. If the editor writes the changes to the original file, the ACL is preserved. If the editor saves the updated contents to a new file that is subsequently renamed to the old filename, the ACLs may be lost, unless the editor supports ACLs. Except for the star archiver, there are currently no backup applications that preserve ACLs.

10.6 For More Information

For more information about ACLs, see the man pages for `getfacl(1)`, `acl(5)`, and `setfacl(1)`.

Encrypting Partitions and Files

Most users have some confidential data on their computer that third parties should not be able to access. The more you rely on mobile computing and on working in different environments and networks, the more carefully you should handle your data. The encryption of files or entire partitions is recommended if others have network or physical access to your system. Laptops or removable media, such as external hard disks or USB sticks, are prone to being lost or stolen. Thus, it is recommended to encrypt the parts of your filesystem that hold confidential data.

There are several ways to protect your data by means of encryption:

Encrypting a Hard Disk Partition

You can create an encrypted partition with YaST during installation or in an already installed system. Refer to Section 11.1.1, “Creating an Encrypted Partition during Installation” (page 151) and Section 11.1.2, “Creating an Encrypted Partition on a Running System” (page 152) for details. This option can also be used for removable media, such as external hard disks, as described in Section 11.1.4, “Encrypting the Content of Removable Media” (page 153).

Creating an Encrypted File as Container

You can create an encrypted file on your hard disk or on a removable medium with YaST at any time. The encrypted file can then be used to *store* other files or folders. For more information, refer to Section 11.1.3, “Creating an Encrypted File as a Container” (page 152).

Encrypting Home Directories

With SUSE Linux Enterprise Server, you can also create encrypted user home directories. When the user logs in to the system, the encrypted home directory is mounted and the contents are made available to the user. Refer to Section 11.2, “Using Encrypted Home Directories” (page 153) for more information.

Encrypting Single ASCII Text Files

If you only have a small number of ASCII text files that hold sensitive or confidential data, you can encrypt them individually and protect them with a password using Kpgp or the vi editor. Refer to Section 11.3, “Using vi to Encrypt Single ASCII Text Files” (page 154) for more information.

WARNING: Encrypted Media Offers Limited Protection

The methods described in this chapter offer only a limited protection. You cannot protect your running system from being compromised. After the encrypted medium is successfully mounted, everybody with appropriate permissions has access to it. However, encrypted media are useful in case of loss or theft of your computer, or to prevent unauthorized individuals from reading your confidential data.

11.1 Setting Up an Encrypted File System with YaST

Use YaST to encrypt partitions or parts of your file system during installation or in an already installed system. However, encrypting a partition in an already-installed system is more difficult, because you have to resize and change existing partitions. In such cases, it may be more convenient to create an encrypted file of a defined size in which to *store* other files or parts of your file system. To encrypt an entire partition, dedicate a partition for encryption in the partition layout. The standard partitioning proposal as suggested by YaST, does not include an encrypted partition by default. Add it manually in the partitioning dialog.

11.1.1 Creating an Encrypted Partition during Installation

WARNING: Password Input

Make sure to memorize the password for your encrypted partitions well. Without that password, you cannot access or restore the encrypted data.

The YaST expert dialog for partitioning offers the options needed for creating an encrypted partition. To create a new encrypted partition proceed as follows:

- 1 Run the YaST Expert Partitioner with *Computer > System > Partitioner*.
- 2 Select a harddisk, click *Add*, and select a primary or an extended partition.
- 3 Select the partition size or the region to use on the disk.
- 4 Select the file system, and mount point of this partition.
- 5 Activate the *Encrypt device* check box.

NOTE: Additional Software Required

After checking *Encrypt device*, a popup window asking for installing additional software may appear. Confirm to install all the required packages to ensure that the encrypted partition works well.

- 6 If the encrypted file system needs to be mounted only when necessary, enable *Do not mount partition* in the *Fstab Options*. otherwise enable *Mount partition* and enter the mount point.
- 7 Click *Next* and enter a password which is used to encrypt this partition. This password is not displayed. To prevent typing errors, you need to enter the password twice.
- 8 Complete the process by clicking *Finish*. The newly-encrypted partition is now created.

When you need to mount an encrypted partition, open your favorite file manager and click on the partition entry in the pane listing common places on your filesystem. You will be prompted for a password and the partition will be mounted.

When you are installing your system on a machine where partitions already exist, you can also decide to encrypt an existing partition during installation. In this case follow the description in Section 11.1.2, “Creating an Encrypted Partition on a Running System” (page 152) and be aware that this action destroys all data on the existing partition.

11.1.2 Creating an Encrypted Partition on a Running System

WARNING: Activating Encryption on a Running System

It is also possible to create encrypted partitions on a running system. However, encrypting an existing partition destroys all data on it, and requires resizing and restructuring of existing partitions.

On a running system, select *System > Partitioner* in the YaST Control Center. Click *Yes* to proceed. In the *Expert Partitioner*, select the partition to encrypt and click *Edit*. The rest of the procedure is the same as described in Section 11.1.1, “Creating an Encrypted Partition during Installation” (page 151).

11.1.3 Creating an Encrypted File as a Container

Instead of using a partition, it is possible to create an encrypted file which can hold other files or folders containing confidential data. Such container files are created from the YaST Expert Partitioner dialog. Select *Crypt Files > Add Crypt File* and enter the full path to the file and its size. If YaST should create the container file, activate the checkbox *Create Loop File*. Accept or change the proposed formatting settings and the file system type. Specify the mount point and make sure that *Encrypt Device* is checked.

Click *Next*, enter your password for decrypting the file, and confirm with *Finish*.

The advantage of encrypted container files over encrypted partitions is that they can be added without repartitioning the hard disk. They are mounted with the help of a loop device and behave just like normal partitions.

11.1.4 Encrypting the Content of Removable Media

YaST treats removable media (like external hard disks or USB flash drives) the same as any other hard disk. Container files or partitions on such media can be encrypted as described above. Do not, however, enable mounting at boot time, because removable media are usually only connected while the system is running.

If you encrypted your removable device with YaST, the KDE and GNOME desktops automatically recognize the encrypted partition and prompt for the password when the device is detected. If you plug in a FAT formatted removable device while running KDE or GNOME, the desktop user entering the password automatically becomes the owner of the device and can read and write files. For devices with a file system other than FAT, change the ownership explicitly for users other than `root` to enable these users to read or write files on the device.

11.2 Using Encrypted Home Directories

To protect data in home directories from being stolen and consequent unauthorized access, use the YaST user management module to enable encryption of home directories. You can create encrypted home directories for new or existing users. To encrypt or decrypt home directories of already existing users, you need to know their login password. See Section “Managing Encrypted Home Directories” (Chapter 12, *Managing Users with YaST*, ↑*Deployment Guide*) for instructions.

Encrypted home partitions are created within a file container as described in Section 11.1.3, “Creating an Encrypted File as a Container” (page 152). Two files are created under `/home` for each encrypted home directory:

`LOGIN.img`

The image holding the directory

LOGIN.key

The image key, protected with the user's login password.

On login, the home directory automatically gets decrypted. Internally, it works through the pam module called *pam_mount*. If you need to add an additional login method that provides encrypted home directories, you have to add this module to the respective configuration file in `/etc/pam.d/`. For more information see also Chapter 2, *Authentication with PAM* (page 17) and the man page of *pam_mount*.

WARNING: Security Restrictions

Encrypting a user's home directory does not provide strong security from other users. If strong security is required, the system should not be shared physically.

To enhance security, also encrypt the `swap` partition and the `/tmp` and `/var/tmp` directories, because these may contain temporary images of critical data. You can encrypt `swap`, `/tmp`, and `/var/tmp` with the YaST partitioner as described in Section 11.1.1, “Creating an Encrypted Partition during Installation” (page 151) or Section 11.1.3, “Creating an Encrypted File as a Container” (page 152).

11.3 Using vi to Encrypt Single ASCII Text Files

The disadvantage of using encrypted partitions is obvious: While the partition is mounted, at least `root` can access the data. To prevent this, *vi* can be used in encrypted mode.

Use *vi -x filename* to edit a new file. *vi* prompts you to set a password, after which it encrypts the content of the file. Whenever you access this file, *vi* requests the correct password.

For even more security, you can place the encrypted text file in an encrypted partition. This is recommended because the encryption used in *vi* is not very strong.

Certificate Store

Certificates play an important role in the authentication of companies and individuals. Usually certificates are administered by the application itself. In some cases, it makes sense to share certificates between applications. The certificate store is a common ground for Firefox, Evolution, and NetworkManager. This chapter explains some details.

The certificate store is a common database for Firefox, Evolution, and NetworkManager at the moment. Other applications that use certificates are not covered but may be in the future. If you have such an application, you can continue to use its private, separate configuration.

12.1 Activating Certificate Store

The configuration is mostly done in the background. To activate it, proceed as follows:

- 1 Decide if you want to activate the certificate store globally (for every user on your system) or specifically to a certain user:

- **For every user** Use the file `/etc/profile.local`
- **For a specific user** Use the file `~/.bashrc`

- 2 Open the file from the previous step and insert the following line:

```
export NSS_USE_SHARED_DB=1
```

Save the file

- 3 Logoff and login into your desktop.

All the certificates are stored under `$HOME/.local/var/pki/nssdb/`.

12.2 Importing Certificates

To import a certificate into the certificate store, do the following:

- 1 Start Firefox.
- 2 Open the dialog from *Edit > Preferences*. Change to *Advanced > Encryption* and click on *View Certificates*.
- 3 Import your certificate depending on your type: use *Servers* to import server certificate, *People* to identify other, and *Your Certificates* to identify yourself.

Intrusion Detection with AIDE

Securing your systems is a mandatory task for any mission-critical system administrator. Because it is impossible to always guarantee that the system is not compromised, it is very important to do extra checks regularly (for example with cron) to ensure that the system is still under your control. This is where AIDE, the *Advanced Intrusion Detection Environment*, comes into play.

13.1 Why Using AIDE?

An easy check that often can reveal unwanted changes can be done by means of RPM. The package manager has a built-in verify function that checks all the managed files in the system for changes. To verify of all files, run the command `rpm -Va`. However, this command will also display changes in configuration files and you will have to do some filtering to detect important changes.

An additional problem to the method with RPM is that an intelligent attacker will modify `rpm` itself to hide any changes that might have been done by some kind of rootkit which allows the attacker to mask its intrusion and gain root privilege. To solve this, you should implement a secondary check that can also be run completely independent of the installed system.

13.2 Setting Up an AIDE Database

IMPORTANT: Initialize AIDE Database After Installation

Before you install your system, verify the checksum of your medium (see Section “Checking Media” (Chapter 32, *Common Problems and Their Solutions*, ↑*Administration Guide*)) to make sure you do not use a compromised source. After you have installed the system, initialize the AIDE database. To be really sure that all went well during and after the installation, do an installation directly on the console, without any network attached to the computer. Do not leave the computer unattended or connected to any network before AIDE creates its database.

AIDE is not installed by default on SUSE Linux Enterprise based systems. To install it, either use *Computer > Install Software*, or enter `zypper install aide` on the command line as `root`.

To tell AIDE which attributes of which files should be checked, use the configuration file `/etc/aide.conf`. This file is also a template and has to be modified to become the actual configuration. The first section of the configuration handles general parameters like the location of the AIDE database file. More relevant for your local configurations are the `Custom Rules` and the `Directories` and `Files` sections. A typical rule looks like the following:

```
Binlib      = p+i+n+u+g+s+b+m+c+md5+sha1
```

After defining the variable `Binlib`, the respective checking options are used in the `files` section. Important options include the following:

Table 13.1 *Important AIDE Checking Options*

Option	Description
p	Check for the file permissions of the selected files or directories.
i	Check for the inode number. Every filename has a unique inode number that should not change.
n	Check for the number of links pointing to the relevant file.

Option	Description
u	Check if the owner of the file has changed.
g	Check if the group of the file has changed.
s	Check if the file size has changed.
b	Check if the block count used by the file has changed.
m	Check if the modification time of the file has changed.
c	Check if the files access time has changed.
md5	Check if the md5 checksum of the file has changed.
sha1	Check if the sha1 (160 Bit) checksum of the file has changed.

A configuration that checks for all files in `/sbin` with the options defined in `Binlib` but omits the directory `/sbin/conf.d/` would look like the following:

```
/sbin Binlib
!/sbin/conf.d
```

To create the AIDE database, proceed as follows:

- 1 Open the file `/etc/aide.conf`.
- 2 Define which files should be checked with which checking options. For a complete list of available checking options, see `/usr/share/doc/packages/aide/manual.html`. The definition of the file selection needs some knowledge about regular expressions. Save your modifications.
- 3 Check if the configuration file is valid. Run the command:

```
aide --config-check
```

Any output of this command is a hint that the configuration is not valid. For example, if you get the following output:

```
aide --config-check
35:syntax error:!
```

```
35:Error while reading configuration:!  
Configuration error
```

The error is to be expected in line 36 of `/etc/aide.conf`. Note that the error message contains the last successfully read line of the configuration file.

- 4 Initialize the AIDE database. Run the command:

```
aide -i
```

- 5 Copy the generated database to a save location like a CD-R or DVD-R, a remote server or a USB disk for later use.

IMPORTANT:

This step is essential as it avoids compromising your database. It is recommended to use a medium which can be written only once to prevent the database being modified. *Never* leave the database on the computer which you want to monitor.

13.3 Local AIDE Checks

To perform a filesystem check, proceed as follows:

- 1 Rename the database:

```
mv /var/lib/aide/aide.db.new /var/lib/aide/aide.db
```

- 2 After any configuration change, you always have to reinitialize the AIDE database and subsequently move the newly generated database. It is also a good idea to make a backup of this database. See Section 13.2, “Setting Up an AIDE Database” (page 158) for more information.

- 3 Perform the check with the following command:

```
aide --check
```

If the output is empty, everything is fine. If AIDE found changes, it displays a summary of changes, for example:

```
aide --check
AIDE found differences between database and filesystem!!
```

```
Summary:
  Total number of files:      1992
  Added files:                0
  Removed files:             0
  Changed files:              1
```

To learn about the actual changes, increase the verbose level of the check with the parameter `-V`. For the previous example, this could look like the following:

```
aide --check -V
AIDE found differences between database and filesystem!!
Start timestamp: 2009-02-18 15:14:10
```

```
Summary:
  Total number of files:      1992
  Added files:                0
  Removed files:             0
  Changed files:              1
```

```
-----
Changed files:
-----
```

```
changed: /etc/passwd
```

```
-----
Detailed information about changes:
-----
```

```
File: /etc/passwd
  Mtime   : 2009-02-18 15:11:02      , 2009-02-18 15:11:47
  Ctime   : 2009-02-18 15:11:02      , 2009-02-18 15:11:47
```

In this example, the file `/etc/passwd` was touched to demonstrate the effect.

13.4 System Independent Checking

For the risk-averse administrator (and of course this is all about risk-aversion) it is advisable to also run the AIDE binary from a trusted source. This excludes the risk that some attacker also modified the aide binary to hide his traces.

To accomplish this task, AIDE must be run from a rescue system that is independent of the installed system. With SUSE Linux it is relatively easy to extend the rescue system with arbitrary programs, and thus add the needed functionality.

Before you can start using the rescue system, you need to provide two packages to the system. These are included with the same syntax as you would add a driver update disk to the system. For a detailed description about the possibilities of linuxrc that are used for this purpose, see <http://en.opensuse.org/Linuxrc>. In the following, one possible way to accomplish this task is discussed.

Procedure 13.1 *Starting a Rescue System with AIDE*

- 1** Provide an FTP server as a second machine.
- 2** Copy the packages `aide` and `mhash` to the FTP server directory, in our case `/srv/ftp/`. Replace the placeholders `ARCH` and `VERSION` with the corresponding values:

```
cp DVD1/suse/ARCH/aideVERSION.ARCH.rpm /srv/ftp
cp DVD1/suse/ARCH/mhashVERSION.ARCH.rpm /srv/ftp
```

- 3** Create an info file `/srv/ftp/info.txt` that provides the needed boot parameters for the rescue system:

```
dud:ftp://ftp.example.com/aideVERSION.ARCH.rpm
dud:ftp://ftp.example.com/mhashVERSION.ARCH.rpm
```

Replace your FTP domain name, `VERSION` and `ARCH` with the values used on your system.

- 4** Restart the server that needs to go through an AIDE check with the Rescue system from your DVD. Add the following string to the boot parameters:

```
info=ftp://ftp.example.com/info.txt
```

This parameter tells linuxrc to also read in all information from the `info.txt` file.

After the rescue system has booted, the AIDE program is ready for use.

13.5 For More Information

Information about AIDE is available at the following places:

- The homepage of AIDE <http://aide.sourceforge.net>
- In the documented template configuration `/etc/aide.conf`.
- In several files below `/usr/share/doc/packages/aide`.
- On the AIDE user mailing list, found at <https://mailman.cs.tut.fi/mailman/listinfo/aide>.

Part III. Network Security

SSH: Secure Network Operations

14

With more and more computers installed in networked environments, it often becomes necessary to access hosts from a remote location. This normally means that a user sends login and password strings for authentication purposes. As long as these strings are transmitted as plain text, they could be intercepted and misused to gain access to that user account without the authorized user even knowing about it. Apart from the fact that this would open all the user's files to an attacker, the illegal account could be used to obtain administrator or `root` access, or to penetrate other systems. In the past, remote connections were established with `telnet`, which offers no guards against eavesdropping in the form of encryption or other security mechanisms. There are other unprotected communication channels, like the traditional FTP protocol and some remote copying programs.

The SSH suite provides the necessary protection by encrypting the authentication strings (usually a login name and a password) and all the other data exchanged between the hosts. With SSH, the data flow could still be recorded by a third party, but the contents are encrypted and cannot be reverted to plain text unless the encryption key is known. So SSH enables secure communication over insecure networks, such as the Internet. The SSH type that comes with SUSE Linux Enterprise Server is OpenSSH.

14.1 The OpenSSH Package

SUSE Linux Enterprise Server installs the package OpenSSH by default. The programs `ssh`, `scp`, and `sftp` are then available as alternatives to `telnet`, `rlogin`, `rsh`, `rcp`, and `ftp`. In the default configuration, system access of a SUSE Linux Enterprise Server system is only possible with the OpenSSH utilities, and only if the firewall permits access.

14.2 The ssh Program

Using the `ssh` program, it is possible to log in to remote systems and work interactively. It replaces both `telnet` and `rlogin`. The `slogin` program is just a symbolic link pointing to `ssh`. For example, log in to the host `sun` with the command `ssh sun`. The host then prompts for the password on `sun`.

After successful authentication, you can work on the remote command line or use interactive applications, such as YaST. If the local username is different from the remote username, you can log in using a different login name with `ssh -l augustine sun` or `ssh augustine@sun`.

Furthermore, `ssh` offers the possibility to run commands on remote systems, as known from `rsh`. In the following example, run the command `uptime` on the host `sun` and create a directory with the name `tmp`. The program output is displayed on the local terminal of the host `jupiter`.

```
ssh otherplanet "uptime; mkdir tmp"
Password:
1:21pm up 2:17, 9 users, load average: 0.15, 0.04, 0.02
```

Quotation marks are necessary here to send both instructions with one command. It is only by doing this that the second command is executed on `sun`.

14.3 scp—Secure Copy

`scp` copies files to a remote machine. It is a secure and encrypted substitute for `rcp`. For example, `scp MyLetter.tex sun:` copies the file `MyLetter.tex` from the host `jupiter` to the host `sun`. If the username on `jupiter` is different than the username on `sun`, specify the latter using the `username@host` format. The `-l` option has a different meaning for this command.

After the correct password is entered, `scp` starts the data transfer and shows a growing row of asterisks, simulating a progress bar. In addition, the program displays the estimated time of arrival to the right of the progress bar. Suppress all output with the option `-q`.

scp also provides a recursive copying feature for entire directories. The command `scp -r src/ sun:backup/` copies the entire contents of the directory `src` including all subdirectories to the `backup` directory on the host `sun`. If this subdirectory does not exist it is created automatically.

The option `-p` tells `scp` to leave the time stamp of files unchanged. `-C` compresses the data transfer. This minimizes the data volume to transfer, but creates a heavier burden on the processor.

14.4 sftp—Secure File Transfer

The `sftp` program can be used instead of `scp` for secure file transfer. During an `sftp` session, you can use many of the commands known from `ftp`. The `sftp` program may be a better choice than `scp`, especially when transferring data for which the filenames are unknown.

14.5 The SSH Daemon (sshd)—Server-Side

To work with the SSH client programs `ssh` and `scp`, a server (the SSH daemon) must be running in the background, listening for connections on TCP/IP port 22. The daemon generates three key pairs when starting for the first time. Each key pair consists of a private and a public key. Therefore, this procedure is referred to as public key-based. To guarantee the security of the communication via SSH, access to the private key files must be restricted to the system administrator. The file permissions are set accordingly by the default installation. The private keys are only required locally by the SSH daemon and must not be given to anyone else. The public key components (recognizable by the name extension `.pub`) are sent to the client requesting the connection. They are readable for all users.

A connection is initiated by the SSH client. The waiting SSH daemon and the requesting SSH client exchange identification data to compare the protocol and software versions, and to prevent connections through the wrong port. Because a child process of the original SSH daemon replies to the request, several SSH connections can be made simultaneously.

For the communication between SSH server and SSH client, OpenSSH supports versions 1 and 2 of the SSH protocol. Version 2 of the SSH protocol is used by default. Override this to use version 1 of the protocol with the `-1` switch. To continue using version 1 after a system update, follow the instructions in `/usr/share/doc/packages/openssh/README.SuSE`. This document also describes how an SSH 1 environment can be transformed into a working SSH 2 environment with just a few steps.

When using version 1 of SSH, the server sends its public host key and a server key, which is regenerated by the SSH daemon every hour. Both allow the SSH client to encrypt a freely chosen session key, which is sent to the SSH server. The SSH client also tells the server which encryption method (cipher) to use.

Version 2 of the SSH protocol does not require a server key. Both sides use an algorithm according to Diffie-Helman to exchange their keys.

The private host and server keys are absolutely required to decrypt the session key and cannot be derived from the public parts. Only the contacted SSH daemon can decrypt the session key using its private keys. This initial connection phase can be watched closely by turning on the verbose debugging option `-v` of the SSH client.

The client stores all public host keys in `~/.ssh/known_hosts` after its first contact with a remote host. This prevents any man-in-the-middle attacks—attempts by foreign SSH servers to use spoofed names and IP addresses. Such attacks are detected either by a host key that is not included in `~/.ssh/known_hosts`, or by the server's inability to decrypt the session key in the absence of an appropriate private counterpart.

It is recommended to back up the private and public keys stored in `/etc/ssh/` in a secure, external location. In this way, key modifications can be detected and the old ones can be used again after reinstallation. This spares users any unsettling warnings. If it is verified that, despite the warning, it is indeed the correct SSH server, the existing entry for the system must be removed from `~/.ssh/known_hosts`.

14.6 SSH Authentication Mechanisms

Now the actual authentication takes place, which, in its simplest form, consists of entering a password as mentioned above. The goal of SSH was to introduce secure software that is also easy to use. Because it is meant to replace rsh and rlogin, SSH must also be

able to provide an authentication method appropriate for daily use. SSH accomplishes this by way of another key pair, which is generated by the user. The SSH package provides a helper program for this: `ssh-keygen`. After entering `ssh-keygen -t rsa` or `ssh-keygen -t dsa`, the key pair is generated and you are prompted for the base filename in which to store the keys.

Confirm the default setting and answer the request for a passphrase. Even if the software suggests an empty passphrase, a text from 10 to 30 characters is recommended for the procedure described here. Do not use short and simple words or phrases. Confirm by repeating the passphrase. Subsequently, you will see where the private and public keys are stored, in this example, the files `id_rsa` and `id_rsa.pub`.

Use `ssh-keygen -p -t rsa` or `ssh-keygen -p -t dsa` to change your old passphrase. Copy the public key component (`id_rsa.pub` in the example) to the remote machine and save it to `~/.ssh/authorized_keys`. You will be asked to authenticate yourself with your passphrase the next time you establish a connection. If this does not occur, verify the location and contents of these files.

In the long run, this procedure is more troublesome than giving your password each time. Therefore, the SSH package provides another tool, `ssh-agent`, which retains the private keys for the duration of an X session. The entire X session is started as a child process of `ssh-agent`. The easiest way to do this is to set the variable `usessh` at the beginning of the `.xsession` file to `yes` and log in via a display manager, such as KDM or XDM. Alternatively, enter `ssh-agent startx`.

Now you can use `ssh` or `scp` as usual. If you have distributed your public key as described above, you are no longer prompted for your password. Take care of terminating your X session or locking it with a password protection application, such as `xlock`.

All the relevant changes that resulted from the introduction of version 2 of the SSH protocol are also documented in the file `/usr/share/doc/packages/openssh/README.SuSE`.

NOTE: File Permissions for Host-Based Authentication

If the host-based authentication is to be used, the file `/usr/lib/ssh/ssh-keysign` or `/usr/lib64/ssh/ssh-keysign` should have `setuid` bit set, which is not the default setting in SUSE Linux Enterprise Server. In such a case, set the file permissions manually. You should use `/etc/permissions.local` for this purpose, to make sure that the `setuid` bit is preserved after security updates of `openssh`.

14.7 X, Authentication, and Forwarding Mechanisms

Beyond the previously described security-related improvements, SSH also simplifies the use of remote X applications. If you run `ssh` with the option `-X`, the `DISPLAY` variable is automatically set on the remote machine and all X output is exported to the remote machine over the existing SSH connection. At the same time, X applications started remotely and locally viewed with this method cannot be intercepted by unauthorized individuals.

By adding the option `-A`, the `ssh-agent` authentication mechanism is carried over to the next machine. This way, you can work from different machines without having to enter a password, but only if you have distributed your public key to the destination hosts and properly saved it there.

Both mechanisms are deactivated in the default settings, but can be permanently activated at any time in the systemwide configuration file `/etc/ssh/sshd_config` or the user's `~/.ssh/config`.

`ssh` can also be used to redirect TCP/IP connections. In the examples below, SSH is told to redirect the SMTP and the POP3 port, respectively:

```
ssh -L 25:sun:25 jupiter
```

With this command, any connection directed to `jupiter` port 25 (SMTP) is redirected to the SMTP port on `sun` via an encrypted channel. This is especially useful for those using SMTP servers without SMTP-AUTH or POP-before-SMTP features. From any arbitrary location connected to a network, e-mail can be transferred to the “home” mail server

for delivery. Similarly, all POP3 requests (port 110) on jupiter can be forwarded to the POP3 port of sun with this command:

```
ssh -L 110:sun:110 jupiter
```

Both commands must be executed as `root`, because the connection is made to privileged local ports. E-mail is sent and retrieved by normal users in an existing SSH connection. The SMTP and POP3 host must be set to `localhost` for this to work. Additional information can be found in the manual pages for each of the programs described above and also in the files under `/usr/share/doc/packages/openssh`.

14.8 Configuring An SSH Daemon with YaST

To configure an `sshd` server with YaST run YaST and choose *Network Services > SSHD Configuration*. Then proceed as follows:

- 1 On the *General* tab, select the ports `sshd` should listen on in the *SSHD TCP Ports* table. The default port number is 22. Multiple ports are allowed. To add a new port, click *Add*, enter the port number and click *OK*. To delete port, select it in the table, click *Delete* and confirm.
- 2 On the *General* tab, select the features the `sshd` daemon should support. To disable TCP forwarding, uncheck *Allow TCP Forwarding*. Disabling TCP forwarding does not improve security unless users are also denied shell access, as they can always install their own forwarders. See Section 14.7, “X, Authentication, and Forwarding Mechanisms” (page 172) for more information about TCP forwarding.

To disable X forwarding, uncheck *Allow X11 Forwarding*. If this option is disabled, any X11 forward requests by the client will return an error. However users can always install their own forwarders. See Section 14.7, “X, Authentication, and Forwarding Mechanisms” (page 172) for more information about X forwarding.

In *Allow Compression* determine, whether the connection between the server and clients should be compressed. After setting these options, click *Next*.

- 3 The *Login Settings* tab contains general login and authentication settings. In *Print Message of the day After Login* determine, whether `sshd` should print message from `/etc/motd` when a user logs in interactively. If you want to disable connection of a user `root`, uncheck *Permit Root Login*.

In *Maximum Authentication Tries* enter the maximum allowed number of authentication attempts per connection. *Password Authentication* specifies whether password authentication is allowed. *RSA Authentication* specifies whether pure RSA authentication is allowed. This option applies to SSH protocol version 1 only. *Public Key Authentication* specifies whether public key authentication is allowed. This option applies to protocol version 2 only.

- 4 On the *Protocol and Ciphers* tab, determine which versions of the SSH protocol should be supported. You can choose to support version 1 only, version 2 only, or to support both SSH version 2 and 1.

Under *Supported Ciphers*, all supported ciphers are listed. You can remove a cipher by selecting it in the list and clicking *Delete*. To add a cipher to the list, select it from the dropdown menu and click *Add*.

- 5 Click *Finish* to save the configuration.

Masquerading and Firewalls

Whenever Linux is used in a network environment, you can use the kernel functions that allow the manipulation of network packets to maintain a separation between internal and external network areas. The Linux netfilter framework provides the means to establish an effective firewall that keeps different networks apart. With the help of iptables—a generic table structure for the definition of rule sets—precisely control the packets allowed to pass a network interface. Such a packet filter can be set up quite easily with the help of SuSEfirewall2 and the corresponding YaST module.

15.1 Packet Filtering with iptables

The components netfilter and iptables are responsible for the filtering and manipulation of network packets as well as for network address translation (NAT). The filtering criteria and any actions associated with them are stored in chains, which must be matched one after another by individual network packets as they arrive. The chains to match are stored in tables. The `iptables` command allows you to alter these tables and rule sets.

The Linux kernel maintains three tables, each for a particular category of functions of the packet filter:

filter

This table holds the bulk of the filter rules, because it implements the *packet filtering* mechanism in the stricter sense, which determines whether packets are let through (ACCEPT) or discarded (DROP), for example.

nat

This table defines any changes to the source and target addresses of packets. Using these functions also allows you to implement *masquerading*, which is a special case of NAT used to link a private network with the Internet.

mangle

The rules held in this table make it possible to manipulate values stored in IP headers (such as the type of service).

These tables contain several predefined chains to match packets:

PREROUTING

This chain is applied to incoming packets.

INPUT

This chain is applied to packets destined for the system's internal processes.

FORWARD

This chain is applied to packets that are only routed through the system.

OUTPUT

This chain is applied to packets originating from the system itself.

POSTROUTING

This chain is applied to all outgoing packets.

Figure 15.1, “iptables: A Packet's Possible Paths” (page 177) illustrates the paths along which a network packet may travel on a given system. For the sake of simplicity, the figure lists tables as parts of chains, but in reality these chains are held within the tables themselves.

In the simplest of all possible cases, an incoming packet destined for the system itself arrives at the `eth0` interface. The packet is first referred to the `PREROUTING` chain of the `mangle` table then to the `PREROUTING` chain of the `nat` table. The following step, concerning the routing of the packet, determines that the actual target of the packet is a process of the system itself. After passing the `INPUT` chains of the `mangle` and the `filter` table, the packet finally reaches its target, provided that the rules of the `filter` table are actually matched.

Figure 15.1 *iptables: A Packet's Possible Paths*

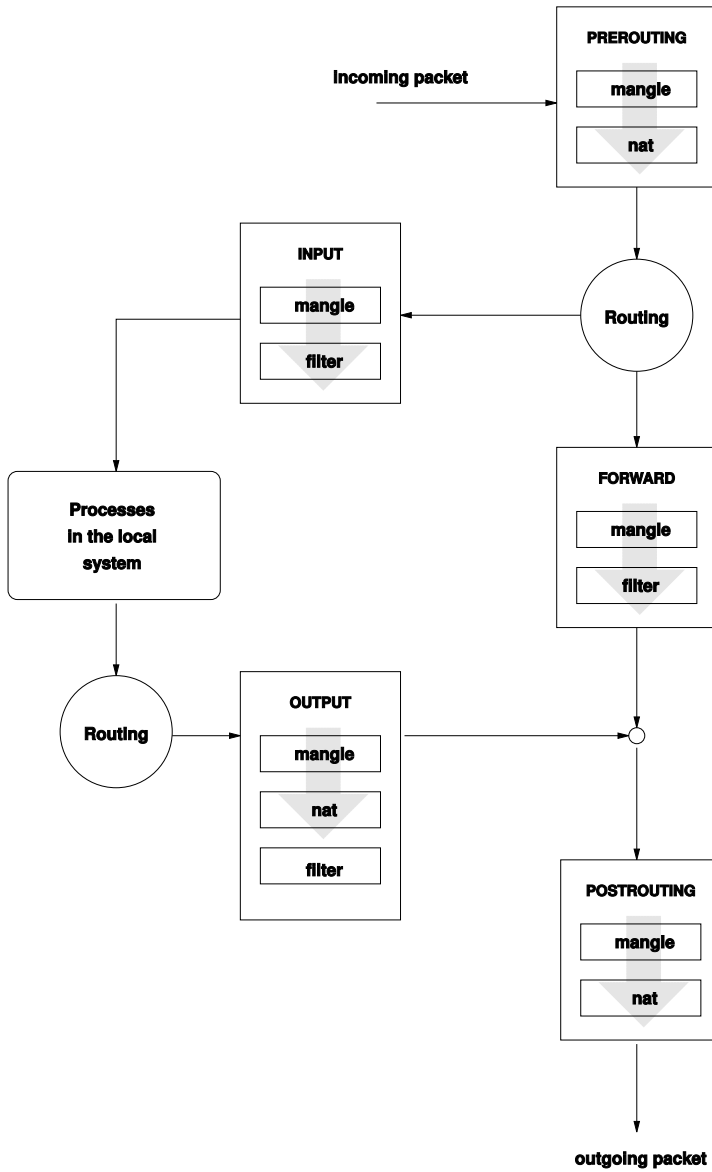

15.2 Masquerading Basics

Masquerading is the Linux-specific form of NAT (network address translation). It can be used to connect a small LAN (where hosts use IP addresses from the private range—see Section “Netmasks and Routing” (Chapter 18, *Basic Networking*, ↑*Administration Guide*)) with the Internet (where official IP addresses are used). For the LAN hosts to be able to connect to the Internet, their private addresses are translated to an official one. This is done on the router, which acts as the gateway between the LAN and the Internet. The underlying principle is a simple one: The router has more than one network interface, typically a network card and a separate interface connecting with the Internet. While the latter links the router with the outside world, one or several others link it with the LAN hosts. With these hosts in the local network connected to the network card (such as `eth0`) of the router, they can send any packets not destined for the local network to their default gateway or router.

IMPORTANT: Using the Correct Network Mask

When configuring your network, make sure both the broadcast address and the netmask are the same for all local hosts. Failing to do so prevents packets from being routed properly.

As mentioned, whenever one of the LAN hosts sends a packet destined for an Internet address, it goes to the default router. However, the router must be configured before it can forward such packets. For security reasons, this is not enabled in a default installation. To enable it, set the variable `IP_FORWARD` in the file `/etc/sysconfig/sysctl` to `IP_FORWARD=yes`.

The target host of the connection can see your router, but knows nothing about the host in your internal network where the packets originated. This is why the technique is called masquerading. Because of the address translation, the router is the first destination of any reply packets. The router must identify these incoming packets and translate their target addresses, so packets can be forwarded to the correct host in the local network.

With the routing of inbound traffic depending on the masquerading table, there is no way to open a connection to an internal host from the outside. For such a connection, there would be no entry in the table. In addition, any connection already established has a status entry assigned to it in the table, so the entry cannot be used by another connection.

As a consequence of all this, you might experience some problems with a number of application protocols, such as ICQ, cueme, IRC (DCC, CTCP), and FTP (in PORT mode). Web browsers, the standard FTP program, and many other programs use the PASV mode. This passive mode is much less problematic as far as packet filtering and masquerading are concerned.

15.3 Firewalling Basics

Firewall is probably the term most widely used to describe a mechanism that provides and manages a link between networks while also controlling the data flow between them. Strictly speaking, the mechanism described in this section is called a *packet filter*. A packet filter regulates the data flow according to certain criteria, such as protocols, ports, and IP addresses. This allows you to block packets that, according to their addresses, are not supposed to reach your network. To allow public access to your Web server, for example, explicitly open the corresponding port. However, a packet filter does not scan the contents of packets with legitimate addresses, such as those directed to your Web server. For example, if incoming packets were intended to compromise a CGI program on your Web server, the packet filter would still let them through.

A more effective but more complex mechanism is the combination of several types of systems, such as a packet filter interacting with an application gateway or proxy. In this case, the packet filter rejects any packets destined for disabled ports. Only packets directed to the application gateway are accepted. This gateway or proxy pretends to be the actual client of the server. In a sense, such a proxy could be considered a masquerading host on the protocol level used by the application. One example for such a proxy is Squid, an HTTP proxy server. To use Squid, the browser must be configured to communicate via the proxy. Any HTTP pages requested are served from the proxy cache and pages not found in the cache are fetched from the Internet by the proxy.

The following section focuses on the packet filter that comes with SUSE Linux Enterprise Server. For further information about packet filtering and firewalling, read the Firewall HOWTO included in the `howto` package. If this package is installed, read the HOWTO with

```
less /usr/share/doc/howto/en/txt/Firewall-HOWTO.gz
```

15.4 SuSEfirewall2

SuSEfirewall2 is a script that reads the variables set in `/etc/sysconfig/SuSEfirewall2` to generate a set of iptables rules. It defines three security zones, although only the first and the second one are considered in the following sample configuration:

External Zone

Given that there is no way to control what is happening on the external network, the host needs to be protected from it. In most cases, the external network is the Internet, but it could be another insecure network, such as a WLAN.

Internal Zone

This refers to the private network, in most cases the LAN. If the hosts on this network use IP addresses from the private range (see Section “Netmasks and Routing” (Chapter 18, *Basic Networking*, ↑*Administration Guide*)), enable network address translation (NAT), so hosts on the internal network can access the external one.

Demilitarized Zone (DMZ)

While hosts located in this zone can be reached both from the external and the internal network, they cannot access the internal network themselves. This setup can be used to put an additional line of defense in front of the internal network, because the DMZ systems are isolated from the internal network.

Any kind of network traffic not explicitly allowed by the filtering rule set is suppressed by iptables. Therefore, each of the interfaces with incoming traffic must be placed into one of the three zones. For each of the zones, define the services or protocols allowed. The rule set is only applied to packets originating from remote hosts. Locally generated packets are not captured by the firewall.

The configuration can be performed with YaST (see Section 15.4.1, “Configuring the Firewall with YaST” (page 181)). It can also be made manually in the file `/etc/sysconfig/SuSEfirewall2`, which is well commented. Additionally, a number of example scenarios are available in `/usr/share/doc/packages/SuSEfirewall2/EXAMPLES`.

15.4.1 Configuring the Firewall with YaST

IMPORTANT: Automatic Firewall Configuration

After the installation, YaST automatically starts a firewall on all configured interfaces. If a server is configured and activated on the system, YaST can modify the automatically-generated firewall configuration with the options *Open Ports on Selected Interface in Firewall* or *Open Ports on Firewall* in the server configuration modules. Some server module dialogs include a *Firewall Details* button for activating additional services and ports. The YaST firewall configuration module can be used to activate, deactivate, or reconfigure the firewall.

The YaST dialogs for the graphical configuration can be accessed from the YaST Control Center. Select *Security and Users > Firewall*. The configuration is divided into seven sections that can be accessed directly from the tree structure on the left side.

Start-Up

Set the start-up behavior in this dialog. In a default installation, SuSEfirewall2 is started automatically. You can also start and stop the firewall here. To implement your new settings in a running firewall, use *Save Settings and Restart Firewall Now*.

Interfaces

All known network interfaces are listed here. To remove an interface from a zone, select the interface, press *Change*, and choose *No Zone Assigned*. To add an interface to a zone, select the interface, press *Change* and choose any of the available zones. You may also create a special interface with your own settings by using *Custom*.

Allowed Services

You need this option to offer services from your system to a zone from which it is protected. By default, the system is only protected from external zones. Explicitly allow the services that should be available to external hosts. After selecting the desired zone in *Allowed Services for Selected Zone*, activate the services from the list.

Masquerading

Masquerading hides your internal network from external networks (such as the Internet) while enabling hosts in the internal network to access the external network transparently. Requests from the external network to the internal one are blocked and requests from the internal network seem to be issued by the masquerading server when seen externally. If special services of an internal machine need to be available to the external network, add special redirect rules for the service.

Broadcast

In this dialog, configure the UDP ports that allow broadcasts. Add the required port numbers or services to the appropriate zone, separated by spaces. See also the file `/etc/services`.

The logging of broadcasts that are not accepted can be enabled here. This may be problematic, because Windows hosts use broadcasts to know about each other and so generate many packets that are not accepted.

IPsec Support

Configure whether the IPsec service should be available to the external network in this dialog. Configure which packets are trusted under *Details*.

Logging Level

There are two rules for the logging: accepted and not accepted packets. Packets that are not accepted are DROPPED or REJECTED. Select from *Log All*, *Log Only Critical*, or *Do Not Log Any* for both of them.

Custom Rules

Here, set special firewall rules that allow connections, matching specified criteria such as source network, protocol, destination port, and source port. Configure such rules for external, internal, and demilitarized zones.

When finished with the firewall configuration, exit this dialog with *Next*. A zone-oriented summary of your firewall configuration then opens. In it, check all settings. All services, ports, and protocols that have been allowed and all custom rules are listed in this summary. To modify the configuration, use *Back*. Press *Finish* to save your configuration.

15.4.2 Configuring Manually

The following paragraphs provide step-by-step instructions for a successful configuration. Each configuration item is marked as to whether it is relevant to firewalling or masquerading. Use port range (for example, 500 : 510) whenever appropriate. Aspects related to the DMZ (demilitarized zone) as mentioned in the configuration file are not covered here. They are applicable only to a more complex network infrastructure found in larger organizations (corporate networks), which require extensive configuration and in-depth knowledge about the subject.

First, use the YaST module System Services (Runlevel) to enable SuSEfirewall2 in your runlevel (3 or 5 most likely). It sets the symlinks for the SuSEfirewall2_* scripts in the `/etc/init.d/rc?.d/` directories.

`FW_DEV_EXT` (firewall, masquerading)

The device linked to the Internet. For a modem connection, enter `ppp0`. For an ISDN link, use `ipp0`. DSL connections use `dsl0`. Specify `auto` to use the interface that corresponds to the default route.

`FW_DEV_INT` (firewall, masquerading)

The device linked to the internal, private network (such as `eth0`). Leave this blank if there is no internal network and the firewall protects only the host on which it runs.

`FW_ROUTE` (firewall, masquerading)

If you need the masquerading function, set this to `yes`. Your internal hosts will not be visible to the outside, because their private network addresses (e.g., `192.168.x.x`) are ignored by Internet routers.

For a firewall without masquerading, set this to `yes` if you want to allow access to the internal network. Your internal hosts need to use officially registered IP addresses in this case. Normally, however, you should *not* allow access to your internal network from the outside.

`FW_MASQUERADE` (masquerading)

Set this to `yes` if you need the masquerading function. This provides a virtually direct connection to the Internet for the internal hosts. It is more secure to have a proxy server between the hosts of the internal network and the Internet. Masquerading is not needed for services that a proxy server provides.

FW_MASQ_NETS (masquerading)

Specify the hosts or networks to masquerade, leaving a space between the individual entries. For example:

```
FW_MASQ_NETS="192.168.0.0/24 192.168.10.1"
```

FW_PROTECT_FROM_INT (firewall)

Set this to *yes* to protect your firewall host from attacks originating in your internal network. Services are only available to the internal network if explicitly enabled.

Also see FW_SERVICES_INT_TCP and FW_SERVICES_INT_UDP.

FW_SERVICES_EXT_TCP (firewall)

Enter the TCP ports that should be made available. Leave this blank for a normal workstation at home that should not offer any services.

FW_SERVICES_EXT_UDP (firewall)

Leave this blank unless you run a UDP service and want to make it available to the outside. The services that use UDP include include DNS servers, IPsec, TFTP, DHCP and others. In that case, enter the UDP ports to use.

FW_SERVICES_ACCEPT_EXT (firewall)

List services to allow from the Internet. This is a more generic form of the FW_SERVICES_EXT_TCP and FW_SERVICES_EXT_UDP settings, and more specific than FW_TRUSTED_NETS. The notation is a space-separated list of *net, protocol [, dport] [, sport]*, for example *0/0, tcp, 22* or *0/0, tcp, 22, , hitcount=3, blockseconds=60, recentname=ssh*, which means: allow at most three ssh connects per minute from the same IP address.

FW_SERVICES_INT_TCP (firewall)

With this variable, define the services available for the internal network. The notation is the same as for FW_SERVICES_EXT_TCP, but the settings are applied to the *internal* network. The variable only needs to be set if

FW_PROTECT_FROM_INT is set to *yes*.

FW_SERVICES_INT_UDP (firewall)

See FW_SERVICES_INT_TCP.

FW_SERVICES_ACCEPT_INT (firewall)

List services to allow from internal hosts. See FW_SERVICES_ACCEPT_EXT.

`FW_SERVICES_ACCEPT_RELATED_*` (firewall)

This is how the SuSEfirewall2 implementation considers packets RELATED by netfilter.

For example, to allow finer grained filtering of Samba broadcast packets, RELATED packets are not accepted unconditionally. Variables starting with `FW_SERVICES_ACCEPT_RELATED_` allow restricting RELATED packets handling to certain networks, protocols and ports.

This means that adding connection tracking modules (conntrack modules) to `FW_LOAD_MODULES` does not automatically result in accepting the packets tagged by those modules. Additionally, you must set variables starting with `FW_SERVICES_ACCEPT_RELATED_` to a suitable value.

`FW_CUSTOMRULES` (firewall)

Uncomment this variable to install custom rules. Find examples in `/etc/sysconfig/scripts/SuSEfirewall2-custom`.

After configuring the firewall, test your setup. The firewall rule sets are created by entering `SuSEfirewall2 start as root`. Then use `telnet`, for example, from an external host to see whether the connection is actually denied. After that, review `/var/log/messages`, where you should see something like this:

```
Mar 15 13:21:38 linux kernel: SFW2-INext-DROP-DEFLT IN=eth0
OUT= MAC=00:80:c8:94:c3:e7:00:a0:c9:4d:27:56:08:00 SRC=192.168.10.0
DST=192.168.10.1 LEN=60 TOS=0x10 PREC=0x00 TTL=64 ID=15330 DF PROTO=TCP
SPT=48091 DPT=23 WINDOW=5840 RES=0x00 SYN URGP=0
OPT (020405B40402080A061AFEBEC0000000001030300)
```

Other packages to test your firewall setup are Nmap (portscanner) or OpenVAS (Open Vulnerability Assessment System). The documentation of Nmap is found at `/usr/share/doc/packages/nmap` after installing the package and the documentation of openVAS resides at <http://www.openvas.org>.

15.5 For More Information

The most up-to-date information and other documentation about the SuSEfirewall2 package is found in `/usr/share/doc/packages/SuSEfirewall2`. The home

page of the netfilter and iptables project, <http://www.netfilter.org>, provides a large collection of documents in many languages.

Configuring VPN Server

Nowadays, the Internet connection is cheap and available almost everywhere. It is important that the connection is as secure as possible. Virtual Private Network (VPN), is a secure network within a second, insecure network such as the Internet or WLAN. It can be implemented in different ways and serves several purposes. In this chapter, we focus on VPNs to link branch offices via secure wide area networks (WANs).

16.1 Overview

This section introduces a brief overview of some scenarios which VPN offers, and some relevant terminology as well.

16.1.1 VPN Scenarios

There are many solutions to set up and build of a VPN connection. This chapter focuses on the OpenVPN package. Compared to other VPN software, OpenVPN can be operated in two modes:

Routed VPN

Routing is an easy solution to set up. It is more efficient and scales better than bridged VPN. Furthermore, it allows the user to tune MTU (Maximum Transfer Unit) to raise efficiency. However, in a heterogeneous environment NetBIOS broadcasts do not work if you do not have a Samba server on the gateway. If you need IPv6, each tun drivers on both ends must support this protocol explicitly.

Figure 16.1 *Routed VPN*

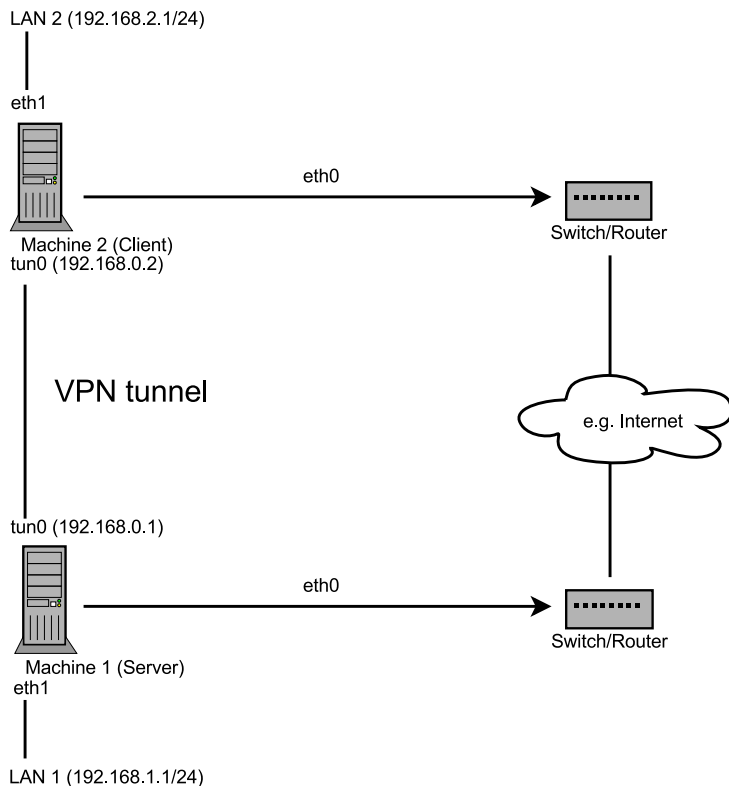

Bridged VPN

Bridging is a more complex solution. It is recommended when you need to browse Windows file shares across the VPN without setting up a Samba or WINS server. Bridged VPN is also needed if you want to use non-IP protocols (such as IPX) or applications relying on network broadcasts. However, it is less efficient than routed VPN. Another disadvantage is that it does not scale well.

Figure 16.2 Bridged VPN - Scenario 1

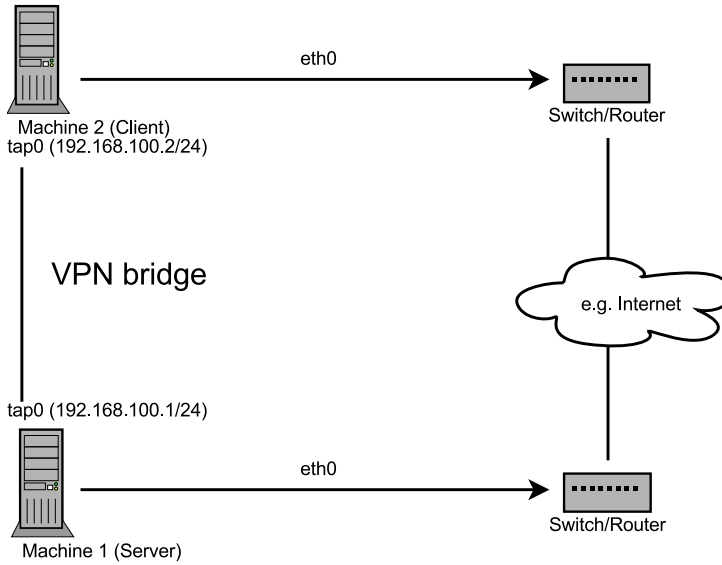

Figure 16.3 Bridged VPN - Scenario 2

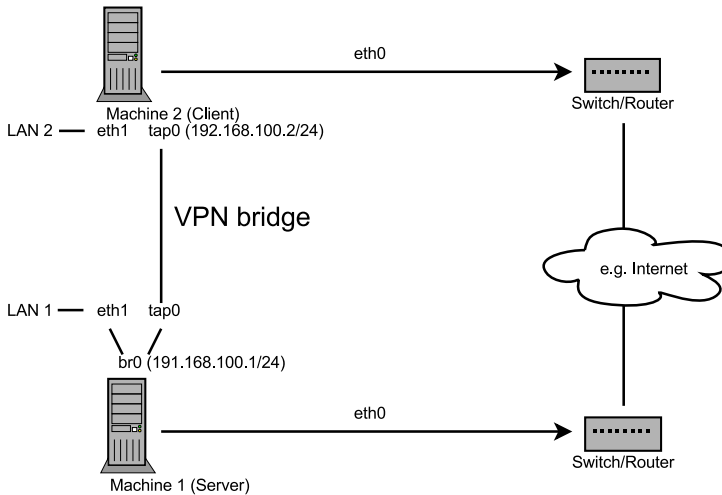
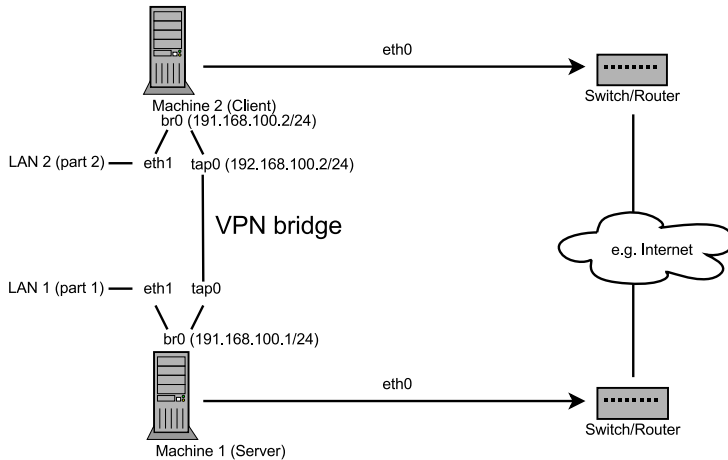

Figure 16.4 Bridged VPN - Scenario 3



The major difference between bridging and routing is that a routed VPN cannot IP-broadcast while a bridged VPN can.

16.1.2 Tun and Tap Devices

Whenever you setup a VPN connection your IP packets are transferred over your secured tunnel. The connection between the client's device and the server's device is called a *tunnel*. A tunnel can use a so-called *tun* or *tap* device. They are virtual network kernel drivers which implement the transmission of ethernet frames or ip frames/packets:

tun device

A tun device simulates a point-to-point network (layer 3 packets in the OSI model such as Ethernet frames). A tun device is used with routing and works with IP frames.

tap device

A tap device simulates an ethernet device (layer 2 packets in the OSI model such as IP packets). A tap device is used for creating a network bridge. It works with Ethernet frames.

The userspace program OpenVPN can attach itself to a tun or tap device to receive packets sent by your OS. The program is also able to write packets to the device. For more information, see `/usr/src/linux/Documentation/networking/tuntap.txt`. You must install the `kernel-source` package to read this file.

16.2 Creating the Simplest VPN Example

The following example creates a point-to-point VPN tunnel. It demonstrates how to create a VPN tunnel between one client and a server. It is assumed that your VPN server will use private IP addresses like `192.168.1.120` and your client the IP address `192.168.2.110`. You can modify these private IP addresses to your needs but make sure you select addresses which do not conflict with other IP addresses.

WARNING: Use It Only For Testing

This scenario is only useful for testing and is considered as an example to get familiar with VPN. *Do not use* this as a real world scenario to connect as it can compromise your security and the safety of your IT infrastructure!

16.2.1 Configuring the VPN Server

To configure a VPN server, do the following:

- 1 Install the packages `openvpn` and `tunctl` on the machine that will later become your VPN server.

- 2 Open a shell, become `root` and create the VPN secret key:

```
openvpn --genkey --secret /etc/openvpn/secret.key
```

- 3 Copy the secret key to your client:

```
scp /etc/openvpn/secret.key root@192.168.2.110:/etc/openvpn/
```

- 4 Create the file `/etc/openvpn/server.conf` with the following content:

```
dev tun
ifconfig 192.168.1.120 192.168.2.110
secret secret.key
```

- 5 If you use a firewall, start YaST and open UDP port 1194.

- 6 Start the OpenVPN service as root:

```
rcopenvpn start
```

16.2.2 Configuring the VPN Client

To configure the VPN client, do the following:

- 1 Install the package `openvpn` on your client VPN machine.
- 2 Create `/etc/openvpn/client.conf` with the following content:

```
remote IP_OF_SERVER
dev tun
ifconfig 192.168.2.110 192.168.1.120
secret secret.key
```

Replace the placeholder `IP_OF_SERVER` in the first line with either the domain name, or the public IP address of your server.

- 3 If you use a firewall, start YaST and open UDP port 1194.

- 4 Start the OpenVPN service as root:

```
rcopenvpn start
```

16.2.3 Testing the VPN Example

After the OpenVPN is successfully started, test if the tun device is available. You can do so with the following command:

```
ifconfig tun0
```

To verify the VPN connection, use `ping` on both client and server to see if you can reach each other. Ping server from client:

```
ping -I tun0 192.168.1.120
```

Ping client from server:

```
ping -I tun0 192.168.2.110
```

16.3 Setting Up Your VPN Server Using Certificate Authority

The example shown in Section 16.2 (page 191) is useful for testing, but not for daily work. This section explains how to build a VPN server that allows more than one connection at the same time. This is done with a public key infrastructure (PKI). A PKI consists of a pair of public and private keys for the server and each client and a master certificate authority (CA), which is used to sign every server and client certificate.

The general overview of this process involves the following steps:

- 1 Section 16.3.1, “Creating Certificates” (page 193).
- 2 Section 16.3.2, “Configuring the Server” (page 196)
- 3 Section 16.3.3, “Configuring the Clients” (page 197)

16.3.1 Creating Certificates

Before a VPN connection gets established, the client must authenticate the server certificate. Conversely, the server must also authenticate the client certificate. This is called *mutual authentication*.

You can use two methods to create the respective certificates and keys:

- Use the YaST CA module (see Chapter 17, *Managing X.509 Certification* (page 203)), or
- Use the scripts included with the `openvpn` package.

Generating Certificates with `easy-rsa`

The `easy-rsa` utilities use the `openssl.cnf` file stored under `/usr/share/openvpn/easy-rsa/VER`. In most cases you can leave this file as it is.

Procedure 16.1 *Generate the Master CA And Key*

- 1 Open a shell and become `root`.
- 2 Change the directory to `/usr/share/openvpn/easy-rsa/VER/`. Replace the placeholder `VER` with the version, currently either `1.0` or `2.0`.
- 3 Copy the file `vars` to `/etc/openvpn` and edit the value of `export EASY_RSA` to `/usr/share/openvpn/easy-rsa`.
- 4 Edit the default values in the file `vars`. Change the variables `KEY_COUNTRY`, `KEY_PROVINCE`, `KEY_CITY`, `KEY_ORG`, and `KEY_EMAIL`.
- 5 Initialize the PKI:

```
source /etc/openvpn/vars && ./clean-all &&
./build-ca
```
- 6 Enter the data required by the `build-ca` script. Usually you can take the defaults that you have set in Step 4 (page 194). The only parameters that are not set are the Organizational Unit Name and Common Name.

After this procedure, the master certificate and key is saved as `/usr/share/openvpn/easy-rsa/VER/keys/ca.*`.

Procedure 16.2 *Generate The Private Server Key*

- 1 Make sure the directory is `/usr/share/openvpn/easy-rsa/VER/`.

2 Run the following script:

```
./build-key-server server
```

The argument (here: `server`) is used for the private key filename.

3 Accept the default parameters, but fill `server` for the `Common Name` option.

4 Answer the next two questions (“Sign the certificate? [y/n]” and “1 out of 1 certificate requests certified, commit? [y/n]”) with `y` (yes).

After this procedure, the private server key is saved `/usr/share/opensvpn/easy-rsa/VER/keys/server.*`.

Procedure 16.3 *Generate Certificates and Keys for a Client*

1 Make sure your current directory is `/usr/share/opensvpn/easy-rsa/VER/`. Replace the placeholder `VER` with the version, currently either `1.0` or `2.0`.

2 Create the key as in Step 2 (page 195) from Procedure 16.2, “Generate The Private Server Key” (page 194):

```
./build-key client
```

3 Repeat the previous step for each client that is allowed to connect to the VPN server. Make sure you use a different name (other than “client”) and an appropriate `Common Name`, because this parameter has to be unique for each client.

After this procedure, the certificate client keys are saved in `/usr/share/opensvpn/easy-rsa/keys/client.*` (depending on the name that you have given for the `build-key` command.)

Procedure 16.4 *Final Configuration Steps*

1 Make sure your current working directory is `/usr/share/opensvpn/easy-rsa/VER/`.

2 Create the Diffie-Hellman parameter:

```
./build-dh
```

3 Create `/etc/openvpn/ssl`.

4 Copy the following files:

```
cp keys/ca.{crt,key} keys/dh1024.pem keys/server.{crt,key}
/etc/openvpn/ssl/
```

5 Copy the client keys to the relevant client machine. You should have the files `client.crt` and `client.key` in the `/etc/openvpn/ssl` directory.

16.3.2 Configuring the Server

The configuration file is mostly a summary of `/usr/share/doc/packages/openvpn/sample-config-files/server.conf` without the comments and with some small changes to some paths.

Example 16.1 VPN Server Configuration File

```
# /etc/openvpn/server.conf
port 1194 ❶
proto udp ❷
dev tun0 ❸

# Security ❹
ca ssl/ca.crt
cert ssl/server.crt
key ssl/server.key
dh ssl/dh1024.pem

server 10.8.0.0 255.255.255.0 ❺
ifconfig-pool-persist /var/run/openvpn/ipp.txt ❻

# Privileges ❼
user nobody
group nobody

# Other configuration ❻
keepalive 10 120
comp-lzo
persist-key
persist-tun
status /var/log/openvpn-status.log
log-append /var/log/openvpn.log
verb 4
```

- ❶ The TCP/UDP port to which OpenVPN listens. You have to open up the port in the Firewall, see Chapter 15, *Masquerading and Firewalls* (page 175). The standard port for VPN is 1194, so in most cases you can leave that as it is.
- ❷ The protocol, either UDP or TCP.
- ❸ The tun or tap device, see Section 16.1.2, “Tun and Tap Devices” (page 190) for the differences.
- ❹ The following lines contain the relative or absolute path to the root server CA certificate (`ca`), the root CA key (`cert`), the private server key (`key`) and the Diffie Hellman parameters (`dh`). These were generated in Section 16.3.1, “Creating Certificates” (page 193).
- ❺ Supplies a VPN subnet. The server can be reached by `10.8.0.1`.
- ❻ Records a mapping of clients and its virtual IP address in the given file. Useful when the server goes down and (after the restart) the clients get their previously assigned IP address.
- ❼ For security reasons it is a good idea to run the OpenVPN daemon with reduced privileges. For this reason the group and user `nobody` is used.
- ❽ Several other configurations, see comment in the original configuration from `/usr/share/doc/packages/openvpn/sample-config-files`.

After this configuration, you can see log messages from your OpenVPN server under `/var/log/openvpn.log`. When you have started it for the first time, it should finish it with:

```
... Initialization Sequence Completed
```

If you do not get this message, check the log carefully. Usually OpenVPN gives you some hints what is wrong in your configuration file.

16.3.3 Configuring the Clients

The configuration file is mostly a summary from `/usr/share/doc/packages/openvpn/sample-config-files/client.conf` without the comments and with some small changes to some paths.

Example 16.2 VPN Client Configuration File

```
# /etc/openvpn/client.conf
client ❶
dev tun ❷
proto udp ❸
remote IP_OR_HOSTNAME 1194 ❹
resolv-retry infinite
nobind

# Privileges ❺
user nobody
group nobody

# Try to preserve some state across restarts.
persist-key
persist-tun

# Security ❻
ca ssl/ca.crt
cert ssl/client.crt
key ssl/client.key

comp-lzo ❼
```

- ❶ We have to specify that this machine is a client.
- ❷ The network device. Both clients and server must use the same device.
- ❸ The protocol. Use the same settings as on the server.
- ❹ Replace the placeholder `IP_OR_HOSTNAME` with the respective hostname or IP address of your VPN server. After the hostname the port of the server is given. You can have multiple lines of `remote` entries pointing to different VPN servers. This is useful for load balancing between different VPN servers.
- ❺ For security reasons it is a good idea to run the OpenVPN daemon with reduced privileges. For this reason the group and user `nobody` is used.
- ❻ Contains the client files. For security reasons, it is better to have a separate file pair for each client.
- ❼ Turns compression on. Use it only when the server has this parameter switched on as well.

16.4 Changing Nameservers in VPN

If you need to change nameservers before or during your VPN session, use `netconfig`.

IMPORTANT: Differences between SUSE Linux Enterprise Desktop and SUSE Linux Enterprise Server

The following procedure is for SUSE Linux Enterprise Servers only without NetworkManager (with `ifup`). SUSE Linux Enterprise Desktop installations use NetworkManager and must install the `NetworkManager-openvpn` plugin.

Use the following procedure to change a nameserver:

Procedure 16.5 Changing Nameservers

- 1 Open a shell and log in as `root`.
- 2 Create the file `/etc/openvpn/client.up` with the following contents:

```
/sbin/netconfig modify -i "${1}" -s openvpn <<EOT
DNSSEARCH='${domain}'
DNSSERVERS='${dns[*]}'
EOT
```
- 3 Start your VPN connection with `rcopenvpn start`.
- 4 Create the file `/etc/openvpn/client.down` with the following contents:

```
/sbin/netconfig remove -i "${1}" -s openvpn
```
- 5 Run `netconfig` and replace the line `DNSSERVERS` with your respective entry:

```
netconfig modify -i tun0 -s openvpn <<EOT
DNSSEARCH='mt-home.net'
DNSSERVERS='192.168.1.116'
EOT
```

To check, if the entry has been successfully inserted into `/etc/resolv.conf`, execute:

```
grep -v ^# /etc/resolv.conf
search mt-home.net mat-home.net
nameserver ...
```

```
nameserver ...
nameserver 192.168.1.116
```

6 To remove the DNS entry, execute:

```
netconfig remove -i tun0 -s openvpn
```

Another example can be found in `/usr/share/doc/packages/openvpn/contrib/pull-resolv-conf/`.

If you need to specify a ranking list of fallback services, use the `NETCONFIG_DNS_RANKING` variable in `/etc/sysconfig/network/config`. The default value is `auto` which is resolved to:

```
+strongswan +openswan +racoon +openvpn -avahi
```

Preferred service names have the `+` suffix, fallback services the `-` suffix.

16.5 KDE- and GNOME Applets For Clients

The following subsections describe how to setup a OpenVPN connection with the GNOME and KDE desktops.

16.5.1 KDE

To setup an OpenVPN connection in KDE4 that can be easily turned on or off, proceed as follows:

- 1** Make sure you have installed the package `NetworkManager-openvpn-kde4` and have resolved all dependencies.
- 2** Right-click on a widget of your panel and select *Panel Options > Add Widgets...*
- 3** Select *Networks*.
- 4** Right-click on the icon and choose *Manage Connections*.

- 5 Add a new VPN connection with *Add > OpenVPN*. A new window opens.
- 6 Choose the *Connection Type* between *X.509 Certificates* or *X.509 With Password* depending on what you have setup with your OpenVPN server.
- 7 Insert the necessary files into the respective text fields. From our example configuration these are:

<i>CA file</i>	<code>/etc/openvpn/ssl/ca.crt</code>
<i>Certificate</i>	<code>/etc/openvpn/ssl/client1.crt</code>
<i>Key</i>	<code>/etc/openvpn/ssl/client1.key</code>
<i>Username</i>	The respective user
<i>Password</i>	The password for the user

- 8 If you have not used the KDE Wallet System, you are asked if you want to configure it. Follow the steps in the wizard. After you have finished this step, you are reverted back to the *Network Settings* dialog.
- 9 Finish with *Ok*.
- 10 Enable the connection with your Network manager applet.

16.5.2 GNOME

To setup a OpenVPN connection in GNOME that can be easily turned on or off, proceed as follows:

- 1 Make sure you have installed the package `NetworkManager-openvpn-gnome` and have resolved all dependencies.
- 2 Start the Network Connection Editor with `Alt + F2` and insert `nm-connection-editor` into the text field. A new window appears.

- 3 Select the *VPN* tab and click *Add*.
- 4 Choose the VPN connection type, in our case *OpenVPN*.
- 5 Choose the *Authentication* type between *Certificates (TLS)* or *Password with Certificates (TLS)* depending on what you have setup with your OpenVPN server.
- 6 Insert the necessary files into the respective text fields. From our example configuration, these are:

<i>Username</i>	The relevant user (only available when you have selected <i>Password with Certificates (TLS)</i>)
<i>Password</i>	The password for the user (only available when you have selected <i>Password with Certificates (TLS)</i>)
<i>User Certificate</i>	<code>/etc/openvpn/ssl/client1.crt</code>
<i>CA Certificate</i>	<code>/etc/openvpn/ssl/ca.crt</code>
<i>Private Key</i>	<code>/etc/openvpn/ssl/client1.key</code>

- 7 Finish with *Apply* and *Close*.
- 8 Enable the connection with your Network Manager applet.

16.6 For More Information

For more information about VPN, visit:

- <http://www.openvpn.net>: Homepage of VPN
- `/usr/share/doc/packages/openvpn/sample-config-files/`: Examples of configuration files for different scenarios

Managing X.509 Certification

An increasing number of authentication mechanisms are based on cryptographic procedures. Digital certificates that assign cryptographic keys to their owners play an important role in this context. These certificates are used for communication and can also be found, for example, on company ID cards. The generation and administration of certificates is mostly handled by official institutions that offer this as a commercial service. In some cases, however, it may make sense to carry out these tasks yourself. For example, if a company does not wish to pass personal data to third parties.

YaST provides two modules for certification, which offer basic management functions for digital X.509 certificates. The following sections explain the basics of digital certification and how to use YaST to create and administer certificates of this type.

17.1 The Principles of Digital Certification

Digital certification uses cryptographic processes to encrypt and protect data from access by unauthorized people. The user data is encrypted using a second data record, or *key*. The key is applied to the user data in a mathematical process, producing an altered data record in which the original content can no longer be identified. Asymmetrical encryption is now in general use (*public key method*). Keys always occur in pairs:

Private Key

The private key must be kept safely by the key owner. Accidental publication of the private key compromises the key pair and renders it useless.

Public Key

The key owner circulates the public key for use by third parties.

17.1.1 Key Authenticity

Because the public key process is in widespread use, there are many public keys in circulation. Successful use of this system requires that every user be sure that a public key actually belongs to the assumed owner. The assignment of users to public keys is confirmed by trustworthy organizations with public key certificates. Such certificates contain the name of the key owner, the corresponding public key, and the electronic signature of the person issuing the certificate.

Trustworthy organizations that issue and sign public key certificates are usually part of a certification infrastructure that is also responsible for the other aspects of certificate management, such as publication, withdrawal, and renewal of certificates. An infrastructure of this kind is generally referred to as a *public key infrastructure* or *PKI*. One familiar PKI is the *OpenPGP* standard in which users publish their certificates themselves without central authorization points. These certificates become trustworthy when signed by other parties in the “web of trust.”

The *X.509 Public Key Infrastructure* (PKIX) is an alternative model defined by the *IETF* (Internet Engineering Task Force) that serves as a model for almost all publicly-used PKIs today. In this model, authentication is made by *certificate authorities* (CA) in a hierarchical tree structure. The root of the tree is the root CA, which certifies all sub-CAs. The lowest level of sub-CAs issue user certificates. The user certificates are trustworthy by certification that can be traced to the root CA.

The security of such a PKI depends on the trustworthiness of the CA certificates. To make certification practices clear to PKI customers, the PKI operator defines a *certification practice statement* (CPS) that defines the procedures for certificate management. This should ensure that the PKI only issues trustworthy certificates.

17.1.2 X.509 Certificates

An X.509 certificate is a data structure with several fixed fields and, optionally, additional extensions. The fixed fields mainly contain the name of the key owner, the public key, and the data relating to the issuing CA (name and signature). For security reasons, a certificate should only have a limited period of validity, so a field is also provided

for this date. The CA guarantees the validity of the certificate in the specified period. The CPS usually requires the PKI (the issuing CA) to create and distribute a new certificate before expiration.

The extensions can contain any additional information. An application is only required to be able to evaluate an extension if it is identified as *critical*. If an application does not recognize a critical extension, it must reject the certificate. Some extensions are only useful for a specific application, such as signature or encryption.

Table 17.1 shows the fields of a basic X.509 certificate in version 3.

Table 17.1 *X.509v3 Certificate*

Field	Content
Version	The version of the certificate, for example, v3
Serial Number	Unique certificate ID (an integer)
Signature	The ID of the algorithm used to sign the certificate
Issuer	Unique name (DN) of the issuing authority (CA)
Validity	Period of validity
Subject	Unique name (DN) of the owner
Subject Public Key Info	Public key of the owner and the ID of the algorithm
Issuer Unique ID	Unique ID of the issuing CA (optional)
Subject Unique ID	Unique ID of the owner (optional)
Extensions	Optional additional information, such as “KeyUsage” or “BasicConstraints”

17.1.3 Blocking X.509 Certificates

If a certificate becomes untrustworthy before it has expired, it must be blocked immediately. This can become necessary if, for example, the private key has accidentally been made public. Blocking certificates is especially important if the private key belongs to a CA rather than a user certificate. In this case, all user certificates issued by the relevant CA must be blocked immediately. If a certificate is blocked, the PKI (the responsible CA) must make this information available to all those involved using a *certificate revocation list* (CRL).

These lists are supplied by the CA to public CRL distribution points (CDPs) at regular intervals. The CDP can optionally be named as an extension in the certificate, so a checker can fetch a current CRL for validation purposes. One way to do this is the *online certificate status protocol* (OCSP). The authenticity of the CRLs is ensured with the signature of the issuing CA. Table 17.2 shows the basic parts of a X.509 CRL.

Table 17.2 X.509 Certificate Revocation List (CRL)

Field	Content
Version	The version of the CRL, such as v2
Signature	The ID of the algorithm used to sign the CRL
Issuer	Unique name (DN) of the publisher of the CRL (usually the issuing CA)
This Update	Time of publication (date, time) of this CRL
Next Update	Time of publication (date, time) of the next CRL
List of revoked certificates	Every entry contains the serial number of the certificate, the time of revocation, and optional extensions (CRL entry extensions)
Extensions	Optional CRL extensions

17.1.4 Repository for Certificates and CRLs

The certificates and CRLs for a CA must be made publicly accessible using a *repository*. Because the signature protects the certificates and CRLs from being forged, the repository itself does not need to be secured in a special way. Instead, it tries to grant the simplest and fastest access possible. For this reason, certificates are often provided on an LDAP or HTTP server. Find explanations about LDAP in Chapter 4, *LDAP—A Directory Service* (page 37). Chapter 27, *The Apache HTTP Server* (↑*Administration Guide*) contains information about the HTTP server.

17.1.5 Proprietary PKI

YaST contains modules for the basic management of X.509 certificates. This mainly involves the creation of CAs, sub-CAs, and their certificates. The services of a PKI go far beyond simply creating and distributing certificates and CRLs. The operation of a PKI requires a well-conceived administrative infrastructure allowing continuous update of certificates and CRLs. This infrastructure is provided by commercial PKI products and can also be partly automated. YaST provides tools for creating and distributing CAs and certificates, but cannot currently offer this background infrastructure. To set up a small PKI, you can use the available YaST modules. However, you should use commercial products to set up an “official” or commercial PKI.

17.2 YaST Modules for CA Management

YaST provides two modules for basic CA management. The primary management tasks with these modules are explained here.

17.2.1 Creating a Root CA

The first step when setting up a PKI is to create a root CA. Do the following:

- 1 Start YaST and go to *Security and Users > CA Management*.
- 2 Click *Create Root CA*.

- 3 Enter the basic data for the CA in the first dialog, shown in Figure 17.1. The text fields have the following meanings:

Figure 17.1 *YaST CA Module—Basic Data for a Root CA*

The screenshot shows a window titled "Create New Root CA (step 1/3)". It contains several input fields and buttons. The "CA Name:" field contains "example-cert". The "Common Name:" field contains "Example CA". Below this is a list of "E-Mail Addresses" with a dropdown menu set to "default". One address, "root@example.org", is selected with a checkmark. To the right of the list are buttons for "Delete", "Default", and "Add". At the bottom, there are fields for "Organization:", "Organizational Unit:", "Locality:", "State:", and "Country:" (set to "Germany"). Navigation buttons "Help", "Back", "About", and "Next" are at the very bottom.

CA Name

Enter the technical name of the CA. Directory names, among other things, are derived from this name, which is why only the characters listed in the help can be used. The technical name is also displayed in the overview when the module is started.

Common Name

Enter the name for use in referring to the CA.

E-Mail Addresses

Several e-mail addresses can be entered that can be seen by the CA user. This can be helpful for inquiries.

Country

Select the country where the CA is operated.

Organisation, Organisational Unit, Locality, State

Optional values

Proceed with *Next*.

- 4 Enter a password in the second dialog. This password is always required when using the CA—when creating a sub-CA or generating certificates. The text fields have the following meaning:

Key Length

Key Length contains a meaningful default and does not generally need to be changed unless an application cannot deal with this key length. The higher the number the more secure your password is.

Valid Period (days)

The *Valid Period* in the case of a CA defaults to 3650 days (roughly ten years). This long period makes sense because the replacement of a deleted CA involves an enormous administrative effort.

Clicking *Advanced Options* opens a dialog for setting different attributes from the X.509 extensions (Figure 17.4, “YaST CA Module—Extended Settings” (page 214)). These values have rational default settings and should only be changed if you are really sure of what you are doing. Proceed with *Next*.

- 5 Review the summary. YaST displays the current settings for confirmation. Click *Create*. The root CA is created then appears in the overview.

TIP

In general, it is best not to allow user certificates to be issued by the root CA. It is better to create at least one sub-CA and create the user certificates from there. This has the advantage that the root CA can be kept isolated and secure, for example, on an isolated computer on secure premises. This makes it very difficult to attack the root CA.

17.2.2 Changing Password

If you need to change your password for your CA, proceed as follows:

- 1 Start YaST and open the CA module.
- 2 Select the required root CA and click *Enter CA*.

- 3 Enter the password if you entered a CA the first time. YaST displays the CA key information in the *Description* tab (see Figure 17.2).
- 4 Click *Advanced* and select *Change CA Password*. A dialog box opens.
- 5 Enter the old and the new password.
- 6 Finish with *OK*

17.2.3 Creating or Revoking a Sub-CA

A sub-CA is created in exactly the same way as a root CA.

NOTE

The validity period for a sub-CA must be fully within the validity period of the “parent” CA. A sub-CA is always created after the “parent” CA, therefore, the default value leads to an error message. To avoid this, enter a permissible value for the period of validity.

Do the following:

- 1 Start YaST and open the CA module.
- 2 Select the required root CA and click *Enter CA*.
- 3 Enter the password if you are entering a CA for the first time. YaST displays the CA key information in the tab *Description* (see Figure 17.2).

Figure 17.2 YaST CA Module—Using a CA



- 4 Click *Advanced* and select *Create SubCA*. This opens the same dialog as for creating a root CA.
- 5 Proceed as described in Section 17.2.1, “Creating a Root CA” (page 207).

It is possible to use one password for all your CAs. Enable *Use CA Password as Certificate Password* to give your sub-CAs the same password as your root CA. This helps to reduce the amount of passwords for your CAs.

NOTE: Check your Valid Period

Take into account that the valid period must be lower than the valid period in the root CA.

- 6 Select the *Certificates* tab. Reset compromised or otherwise unwanted sub-CAs here, using *Revoke*. Revocation alone is not enough to deactivate a sub-CA. You must also publish revoked sub-CAs in a CRL. The creation of CRLs is described in Section 17.2.6, “Creating CRLs” (page 215).
- 7 Finish with *OK*

17.2.4 Creating or Revoking User Certificates

Creating client and server certificates is very similar to creating CAs in Section 17.2.1, “Creating a Root CA” (page 207). The same principles apply here. In certificates intended for e-mail signature, the e-mail address of the sender (the private key owner) should be contained in the certificate to enable the e-mail program to assign the correct certificate. For certificate assignment during encryption, it is necessary for the e-mail address of the recipient (the public key owner) to be included in the certificate. In the case of server and client certificates, the hostname of the server must be entered in the *Common Name* field. The default validity period for certificates is 365 days.

To create client and server certificates, do the following:

- 1 Start YaST and open the CA module.
- 2 Select the required root CA and click *Enter CA*.
- 3 Enter the password if you are entering a CA for the first time. YaST displays the CA key information in the *Description* tab.
- 4 Click *Certificates* (see Figure 17.3).

Figure 17.3 Certificates of a CA

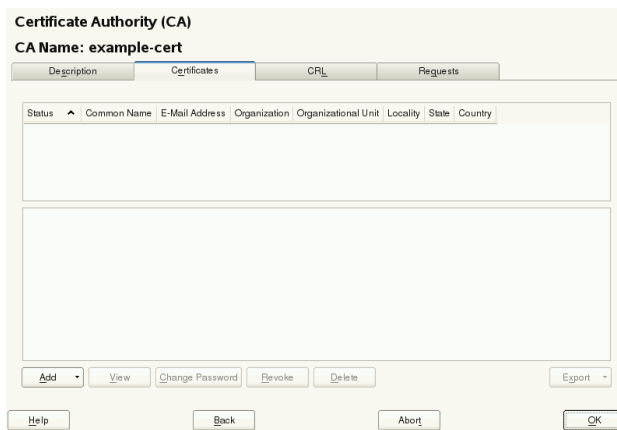

- 5 Click *Add > Add Server Certificate* and create a server certificate.
- 6 Click *Add > Add Client Certificate* and create a client certificate. Do not forget to enter an e-mail address.
- 7 Finish with *OK*

To revoke compromised or otherwise unwanted certificates, do the following:

- 1 Start YaST and open the CA module.
- 2 Select the required root CA and click *Enter CA*.
- 3 Enter the password if you are entering a CA for the first time. YaST displays the CA key information in the *Description* tab.
- 4 Click *Certificates* (see Section 17.2.3, “Creating or Revoking a Sub-CA” (page 210).)
- 5 Select the certificate to revoke and click *Revoke*.
- 6 Choose a reason to revoke this certificate
- 7 Finish with *OK*.

NOTE

Revocation alone is not enough to deactivate a certificate. Also publish revoked certificates in a CRL. Section 17.2.6, “Creating CRLs” (page 215) explains how to create CRLs. Revoked certificates can be completely removed after publication in a CRL with *Delete*.

17.2.5 Changing Default Values

The previous sections explained how to create sub-CAs, client certificates, and server certificates. Special settings are used in the extensions of the X.509 certificate. These settings have been given rational defaults for every certificate type and do not normally need to be changed. However, it may be that you have special requirements for these

extensions. In this case, it may make sense to adjust the defaults. Otherwise, start from scratch every time you create a certificate.

- 1 Start YaST and open the CA module.
- 2 Enter the required root CA, as described in Section 17.2.3, “Creating or Revoking a Sub-CA” (page 210).
- 3 Click *Advanced > Edit Defaults*.
- 4 Choose the type the settings to change. The dialog for changing the defaults, shown in Figure 17.4, “YaST CA Module—Extended Settings” (page 214), then opens.

Figure 17.4 YaST CA Module—Extended Settings

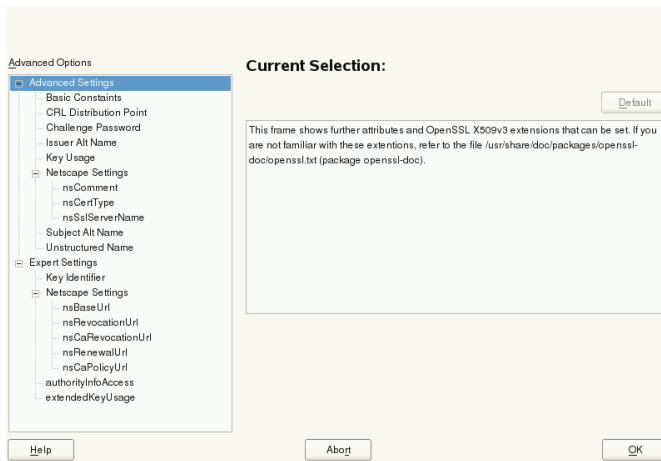

- 5 Change the associated value on the right side and set or delete the critical setting with *critical*.
- 6 Click *Next* to see a short summary.
- 7 Finish your changes with *Save*.

NOTE

All changes to the defaults only affect objects created after this point. Already-existing CAs and certificates remain unchanged.

17.2.6 Creating CRLs

If compromised or otherwise unwanted certificates need to be excluded from further use, they must first be revoked. The procedure for this is explained in Section 17.2.3, “Creating or Revoking a Sub-CA” (page 210) (for sub-CAs) and Section 17.2.4, “Creating or Revoking User Certificates” (page 212) (for user certificates). After this, a CRL must be created and published with this information.

The system maintains only one CRL for each CA. To create or update this CRL, do the following:

- 1 Start YaST and open the CA module.
- 2 Enter the required CA, as described in Section 17.2.3, “Creating or Revoking a Sub-CA” (page 210).
- 3 Click *CRL*. The dialog that opens displays a summary of the last CRL of this CA.
- 4 Create a new CRL with *Generate CRL* if you have revoked new sub-CAs or certificates since its creation.
- 5 Specify the period of validity for the new CRL (default: 30 days).
- 6 Click *OK* to create and display the CRL. Afterwards, you must publish this CRL.

NOTE

Applications that evaluate CRLs reject every certificate if the CRL is not available or has expired. As a PKI provider, it is your duty always to create and publish a new CRL before the current CRL expires (period of validity). YaST does not provide a function for automating this procedure.

17.2.7 Exporting CA Objects to LDAP

The executing computer should be configured with the YaST LDAP client for LDAP export. This provides LDAP server information at runtime that can be used when completing dialog fields. Otherwise (although export may be possible), all LDAP data must be entered manually. You must always enter several passwords (see Table 17.3, “Passwords during LDAP Export” (page 216)).

Table 17.3 Passwords during LDAP Export

Password	Meaning
LDAP Password	Authorizes the user to make entries in the LDAP tree.
Certificate Password	Authorizes the user to export the certificate.
New Certificate Password	The PKCS12 format is used during LDAP export. This format forces the assignment of a new password for the exported certificate.

Certificates, CAs, and CRLs can be exported to LDAP.

Exporting a CA to LDAP

To export a CA, enter the CA as described in Section 17.2.3, “Creating or Revoking a Sub-CA” (page 210). Select *Extended > Export to LDAP* in the subsequent dialog, which opens the dialog for entering LDAP data. If your system has been configured with the YaST LDAP client, the fields are already partly completed. Otherwise, enter all the data manually. Entries are made in LDAP in a separate tree with the attribute “caCertificate”.

Exporting a Certificate to LDAP

Enter the CA containing the certificate to export then select *Certificates*. Select the required certificate from the certificate list in the upper part of the dialog and select *Export > Export to LDAP*. The LDAP data is entered here in the same way as for CAs. The certificate is saved with the corresponding user object in the LDAP tree with the attributes “userCertificate” (PEM format) and “userPKCS12” (PKCS12 format).

Exporting a CRL to LDAP

Enter the CA containing the CRL to export and select *CRL*. If desired, create a new CRL and click *Export*. The dialog that opens displays the export parameters. You can export the CRL for this CA either once or in periodical time intervals. Activate the export by selecting *Export to LDAP* and enter the respective LDAP data. To do this at regular intervals, select the *Repeated Recreation and Export* radio button and change the interval, if appropriate.

17.2.8 Exporting CA Objects as a File

If you have set up a repository on the computer for administering CAs, you can use this option to create the CA objects directly as a file at the correct location. Different output formats are available, such as PEM, DER, and PKCS12. In the case of PEM, it is also possible to choose whether a certificate should be exported with or without key and whether the key should be encrypted. In the case of PKCS12, it is also possible to export the certification path.

Export a file in the same way for certificates, CAs as with LDAP, described in Section 17.2.7, “Exporting CA Objects to LDAP” (page 216), except you should select *Export as File* instead of *Export to LDAP*. This then takes you to a dialog for selecting the required output format and entering the password and filename. The certificate is stored at the required location after clicking *OK*.

For CRLs click *Export*, select *Export to file*, choose the export format (PEM or DER) and enter the path. Proceed with *OK* to save it to the respective location.

TIP

You can select any storage location in the file system. This option can also be used to save CA objects on a transport medium, such as a USB stick. The `/media` directory generally holds any type of drive except the hard drive of your system.

17.2.9 Importing Common Server Certificates

If you have exported a server certificate with YaST to your media on an isolated CA management computer, you can import this certificate on a server as a *common server certificate*. Do this during installation or at a later point with YaST.

NOTE

You need one of the PKCS12 formats to import your certificate successfully.

The general server certificate is stored in `/etc/ssl/servercerts` and can be used there by any CA-supported service. When this certificate expires, it can easily be replaced using the same mechanisms. To get things functioning with the replaced certificate, restart the participating services.

TIP

If you select *Import* here, you can select the source in the file system. This option can also be used to import certificates from a transport medium, such as a USB stick.

To import a common server certificate, do the following:

- 1 Start YaST and open *Common Server Certificate* under *Security and Users*
- 2 View the data for the current certificate in the description field after YaST has been started.
- 3 Select *Import* and the certificate file.
- 4 Enter the password and click *Next*. The certificate is imported then displayed in the description field.
- 5 Close YaST with *Finish*.

17.3 For More Information

Detailed information about X.509 certificates, refer to <http://www.ietf.org/html.charters/pkix-charter.html>.

Part IV. Confining Privileges with Novell AppArmor

Introducing AppArmor

Many security vulnerabilities result from bugs in *trusted* programs. A trusted program runs with privileges that attackers would like to have. The program fails to keep that trust if there is a bug in the program that allows the attacker to acquire said privilege.

Novell® AppArmor is an application security solution designed specifically to apply privilege confinement to suspect programs. AppArmor allows the administrator to specify the domain of activities the program can perform by developing a security *profile* for that application (a listing of files that the program may access and the operations the program may perform). AppArmor secures applications by enforcing good application behavior without relying on attack signatures, so it can prevent attacks even if previously unknown vulnerabilities are being exploited.

Novell AppArmor consists of:

- A library of AppArmor profiles for common Linux* applications, describing what files the program needs to access.
- A library of AppArmor profile foundation classes (profile building blocks) needed for common application activities, such as DNS lookup and user authentication.
- A tool suite for developing and enhancing AppArmor profiles, so that you can change the existing profiles to suit your needs and create new profiles for your own local and custom applications.
- Several specially modified applications that are AppArmor enabled to provide enhanced security in the form of unique subprocess confinement (including Apache and Tomcat).

- The Novell AppArmor–loadable kernel module and associated control scripts to enforce AppArmor policies on your SUSE® Linux Enterprise Server system.

18.1 Background Information on AppArmor Profiling

For more information about the science and security of Novell AppArmor, refer to the following papers:

SubDomain: Parsimonious Server Security by Crispin Cowan, Steve Beattie, Greg Kroah-Hartman, Calton Pu, Perry Wagle, and Virgil Gligor

Describes the initial design and implementation of Novell AppArmor. Published in the proceedings of the USENIX LISA Conference, December 2000, New Orleans, LA. This paper is now out of date, describing syntax and features that are different from the current Novell AppArmor product. This paper should be used only for background, and not for technical documentation.

Defcon Capture the Flag: Defending Vulnerable Code from Intense Attack by Crispin Cowan, Seth Arnold, Steve Beattie, Chris Wright, and John Viega

A good guide to strategic and tactical use of Novell AppArmor to solve severe security problems in a very short period of time. Published in the Proceedings of the DARPA Information Survivability Conference and Expo (DISCEX III), April 2003, Washington, DC.

AppArmor for Geeks by Seth Arnold

This document tries to convey a better understanding of the technical details of AppArmor. It is available at http://en.opensuse.org/AppArmor_Geeks.

AppArmor Technical Documentation by Andreas Gruenbacher and Seth Arnold

This document discusses the concept and design of AppArmor from a very technical point of view. It is available at http://forgeftp.novell.com//apparmor/LKML_Submission-June-07/techdoc.html.

Getting Started

Prepare a successful deployment of Novell AppArmor on your system by carefully considering the following items:

- 1** Determine the applications to profile. Read more on this in Section 19.3, “Choosing the Applications to Profile” (page 227).
- 2** Build the needed profiles as roughly outlined in Section 19.4, “Building and Modifying Profiles” (page 228). Check the results and adjust the profiles when necessary.
- 3** Keep track of what is happening on your system by running AppArmor reports and dealing with security events. Refer to Section 19.5, “Configuring Novell AppArmor Event Notification and Reports” (page 230).
- 4** Update your profiles whenever your environment changes or you need to react to security events logged by AppArmor's reporting tool. Refer to Section 19.6, “Updating Your Profiles” (page 232).

19.1 Installing Novell AppArmor

Novell AppArmor is installed and running on any installation of SUSE® Linux Enterprise Server by default, regardless of what patterns are installed. The packages listed below are needed for a fully-functional instance of AppArmor

- `apparmor-docs`
- `apparmor-parser`
- `apparmor-profiles`
- `apparmor-utils`
- `audit`
- `libapparmor1`
- `perl-libapparmor`
- `yast2-apparmor`

19.2 Enabling and Disabling Novell AppArmor

Novell AppArmor is configured to run by default on any fresh installation of SUSE Linux Enterprise Server. There are two ways of toggling the status of AppArmor:

Using YaST System Services (Runlevel)

Disable or enable AppArmor by removing or adding its boot script to the sequence of scripts executed on system boot. Status changes are applied on reboot.

Using Novell AppArmor Control Panel

Toggle the status of Novell AppArmor in a running system by switching it off or on using the YaST Novell AppArmor Control Panel. Changes made here are applied instantaneously. The Control Panel triggers a stop or start event for AppArmor and removes or adds its boot script in the system's boot sequence.

To disable AppArmor permanently (by removing it from the sequence of scripts executed on system boot) proceed as follows:

- 1 Start YaST.
- 2 Select *System > System Services (Runlevel)*.
- 3 Select *Expert Mode*.
- 4 Select `boot . apparmor` and click *Set/Reset > Disable the service*.
- 5 Exit the YaST Runlevel tool with *Finish*.

AppArmor will not be initialized on reboot, and stays inactive until you reenable it. Reenabling a service using the YaST Runlevel tool is similar to disabling it.

Toggle the status of AppArmor in a running system by using the AppArmor Control Panel. These changes take effect as soon as you apply them and survive a reboot of the system. To toggle AppArmor's status, proceed as follows:

- 1 Start YaST.
- 2 Select *Novell AppArmor > AppArmor Control Panel*.
- 3 Select *Enable AppArmor*. To disable AppArmor, uncheck this option.
- 4 Exit the AppArmor Control Panel with *Done*.

19.3 Choosing the Applications to Profile

You only need to protect the programs that are exposed to attacks in your particular setup, so only use profiles for those applications you actually run. Use the following list to determine the most likely candidates:

Network Agents
Web Applications
Cron Jobs

To find out which processes are currently running with open network ports and might need a profile to confine them, run `aa-unconfined` as `root`.

Example 19.1 *Output of `aa-unconfined`*

```
19848 /usr/sbin/cupsd not confined
19887 /usr/sbin/sshd not confined
19947 /usr/lib/postfix/master not confined
29205 /usr/sbin/sshd confined by '/usr/sbin/sshd (enforce)'
```

Each of the processes in the above example labeled `not confined` might need a custom profile to confine it. Those labeled `confined by` are already protected by AppArmor.

TIP: For More Information

For more information about choosing the the right applications to profile, refer to Section 20.2, “Determining Programs to Immunize” (page 236).

19.4 Building and Modifying Profiles

Novell AppArmor on SUSE Linux Enterprise Server ships with a preconfigured set of profiles for the most important applications. In addition, you can use AppArmor to create your own profiles for any application you want.

There are two ways of managing profiles. One is to use the graphical front-end provided by the YaST Novell AppArmor modules and the other is to use the command line tools provided by the AppArmor suite itself. Both methods basically work the same way.

For each application, perform the following steps to create a profile:

- 1 As `root`, let AppArmor create a rough outline of the application's profile by running `aa-genprof programname`

or

Outline the basic profile by running *YaST > Novell AppArmor > Add Profile Wizard* and specifying the complete path to the application you want to profile.

A basic profile is outlined and AppArmor is put into learning mode, which means that it logs any activity of the program you are executing, but does not yet restrict it.

- 2 Run the full range of the application's actions to let AppArmor get a very specific picture of its activities.
- 3 Let AppArmor analyze the log files generated in Step 2 (page 229) by typing `S` in `aa-genprof`.

or

Analyze the logs by clicking *Scan System Log for AppArmor Events* in the *Add Profile Wizard* and following the instructions given in the wizard until the profile is completed.

AppArmor scans the logs it recorded during the application's run and asks you to set the access rights for each event that was logged. Either set them for each file or use globbing.

- 4 Depending on the complexity of your application, it might be necessary to repeat Step 2 (page 229) and Step 3 (page 229). Confine the application, exercise it under the confined conditions, and process any new log events. To properly confine the full range of an application's capabilities, you might be required to repeat this procedure often.
- 5 Once all access permissions are set, your profile is set to enforce mode. The profile is applied and AppArmor restricts the application according to the profile just created.

If you started `aa-genprof` on an application that had an existing profile that was in complain mode, this profile remains in learning mode upon exit of this learning cycle. For more information about changing the mode of a profile, refer to Section “aa-complain—Entering Complain or Learning Mode” (page 299) and Section “aa-enforce—Entering Enforce Mode” (page 300).

Test your profile settings by performing every task you need with the application you just confined. Normally, the confined program runs smoothly and you do not notice

AppArmor activities at all. However, if you notice certain misbehavior with your application, check the system logs and see if AppArmor is too tightly confining your application. Depending on the log mechanism used on your system, there are several places to look for AppArmor log entries:

```
/var/log/audit/audit.log  
/var/log/messages  
dmesg
```

To adjust the profile, analyze the log messages relating to this application again as described in Step 3 (page 229). Determine the access rights or restrictions when prompted.

TIP: For More Information

For more information about profile building and modification, refer to Chapter 21, *Profile Components and Syntax* (page 243), Chapter 23, *Building and Managing Profiles with YaST* (page 271), and Chapter 24, *Building Profiles from the Command Line* (page 291).

19.5 Configuring Novell AppArmor Event Notification and Reports

Set up event notification in Novell AppArmor so you can review security events. Event Notification is an Novell AppArmor feature that informs a specified e-mail recipient when systemic Novell AppArmor activity occurs under the chosen severity level. This feature is currently available in the YaST interface.

To set up event notification in YaST, proceed as follows:

- 1 Make sure that a mail server is running on your system to deliver the event notifications.
- 2 Start YaST. Then select *Novell AppArmor > AppArmor Control Panel*. In *Security Event Notification*, select *Configure*.
- 3 For each record type (*Terse*, *Summary*, and *Verbose*), set a report frequency, enter the e-mail address that should receive the reports, and determine the

severity of events to log. To include unknown events in the event reports, check *Include Unknown Severity Events*.

NOTE: Selecting Events to Log

Unless you are familiar with AppArmor's event categorization, choose to be notified about events for all security levels.

- 4 Leave this dialog with *OK > Done* to apply your settings.

Using Novell AppArmor reports, you can read important Novell AppArmor security events reported in the log files without manually sifting through the cumbersome messages only useful to the *aa-logprof* tool. You can decrease the size of the report by filtering by date range or program name.

To configure the AppArmor reports, proceed as follows:

- 1 Start YaST. Select *Novell AppArmor > AppArmor Reports*.
- 2 Select the type of report to examine or configure from *Executive Security Summary*, *Applications Audit*, and *Security Incident Report*.
- 3 Edit the report generation frequency, e-mail address, export format, and location of the reports by selecting *Edit* and providing the requested data.
- 4 To run a report of the selected type, click *Run Now*.
- 5 Browse through the archived reports of a given type by selecting *View Archive* and specifying the report type.

or

Delete unneeded reports or add new ones.

TIP: For More Information

For more information about configuring event notification in Novell AppArmor, refer to Section 27.2, “Configuring Security Event Notification” (page 334). Find more information about report configuration in Section 27.3, “Configuring Reports” (page 337).

19.6 Updating Your Profiles

Software and system configurations change over time. As a result, your profile setup for AppArmor might need some fine-tuning from time to time. AppArmor checks your system log for policy violations or other AppArmor events and lets you adjust your profile set accordingly. Any application behavior that is outside of any profile definition can also be addressed using the *Update Profile Wizard*.

To update your profile set, proceed as follows:

- 1 Start YaST and choose *Novell AppArmor > Update Profile Wizard*.
- 2 Adjust access or execute rights to any resource or for any executable that has been logged when prompted.
- 3 Leave YaST after you have answered all questions. Your changes are applied to the respective profiles.

TIP: For More Information

For more information about updating your profiles from the system logs, refer to Section 23.5, “Updating Profiles from Log Entries” (page 287).

Immunizing Programs

Effective hardening of a computer system requires minimizing the number of programs that mediate privilege, then securing the programs as much as possible. With Novell AppArmor, you only need to profile the programs that are exposed to attack in your environment, which drastically reduces the amount of work required to harden your computer. AppArmor profiles enforce policies to make sure that programs do what they are supposed to do, but nothing else.

Novell® AppArmor provides immunization technologies that protect applications from the inherent vulnerabilities they possess. After installing Novell AppArmor, setting up Novell AppArmor profiles, and rebooting the computer, your system becomes immunized because it begins to enforce the Novell AppArmor security policies. Protecting programs with Novell AppArmor is referred to as *immunizing*.

Administrators need only concern themselves with the applications that are vulnerable to attacks, and generate profiles for these. Hardening a system thus comes down to building and maintaining the AppArmor profile set and monitoring any policy violations or exceptions logged by AppArmor's reporting facility.

Users should not notice AppArmor at all. It runs “behind the scenes” and does not require any user interaction. Performance is not noticeably affected by AppArmor. If some activity of the application is not covered by an AppArmor profile or if some activity of the application is prevented by AppArmor, the administrator needs to adjust the profile of this application to cover this kind of behavior.

Novell AppArmor sets up a collection of default application profiles to protect standard Linux services. To protect other applications, use the Novell AppArmor tools to create profiles for the applications that you want protected. This chapter introduces the philos-

ophy of immunizing programs. Proceed to Chapter 21, *Profile Components and Syntax* (page 243), Chapter 23, *Building and Managing Profiles with YaST* (page 271), or Chapter 24, *Building Profiles from the Command Line* (page 291) if you are ready to build and manage Novell AppArmor profiles.

Novell AppArmor provides streamlined access control for network services by specifying which files each program is allowed to read, write, and execute, and which type of network it is allowed to access. This ensures that each program does what it is supposed to do, and nothing else. Novell AppArmor quarantines programs to protect the rest of the system from being damaged by a compromised process.

Novell AppArmor is a host intrusion prevention or mandatory access control scheme. Previously, access control schemes were centered around users because they were built for large timeshare systems. Alternatively, modern network servers largely do not permit users to log in, but instead provide a variety of network services for users (such as Web, mail, file, and print servers). Novell AppArmor controls the access given to network services and other programs to prevent weaknesses from being exploited.

TIP: Background Information for Novell AppArmor

To get a more in-depth overview of AppArmor and the overall concept behind it, refer to Section 18.1, “Background Information on AppArmor Profiling” (page 224).

20.1 Introducing the AppArmor Framework

This section provides a very basic understanding of what is happening “behind the scenes” (and under the hood of the YaST interface) when you run AppArmor.

An AppArmor profile is a plain text file containing path entries and access permissions. See Section 21.1, “Breaking a Novell AppArmor Profile into Its Parts” (page 244) for a detailed reference profile. The directives contained in this text file are then enforced by the AppArmor routines to quarantine the process or program.

The following tools interact in the building and enforcement of AppArmor profiles and policies:

`aa-unconfined / unconfined`

`aa-unconfined` detects any application running on your system that listens for network connections and is not protected by an AppArmor profile. Refer to Section “`aa-unconfined—Identifying Unprotected Processes`” (page 316) for detailed information about this tool.

`aa-autodep / autodep`

`aa-autodep` creates a basic framework of a profile that needs to be fleshed out before it is put to use in production. The resulting profile is loaded and put into complain mode, reporting any behavior of the application that is not (yet) covered by AppArmor rules. Refer to Section “`aa-autodep—Creating Approximate Profiles`” (page 298) for detailed information about this tool.

`aa-genprof / genprof`

`aa-genprof` generates a basic profile and asks you to refine this profile by executing the application and generating log events that need to be taken care of by AppArmor policies. You are guided through a series of questions to deal with the log events that have been triggered during the application's execution. After the profile has been generated, it is loaded and put into enforce mode. Refer to Section “`aa-genprof—Generating Profiles`” (page 301) for detailed information about this tool.

`aa-logprof / logprof`

`aa-logprof` interactively scans and reviews the log entries generated by an application that is confined by an AppArmor profile in complain mode. It assists you in generating new entries in the profile concerned. Refer to Section “`aa-logprof—Scanning the System Log`” (page 310) for detailed information about this tool.

`aa-complain / complain`

`aa-complain` toggles the mode of an AppArmor profile from enforce to complain. Exceptions to rules set in a profile are logged, but the profile is not enforced. Refer to Section “`aa-complain—Entering Complain or Learning Mode`” (page 299) for detailed information about this tool.

`aa-enforce / enforce`

`aa-enforce` toggles the mode of an AppArmor profile from complain to enforce. Exceptions to rules set in a profile are logged, but not permitted—the profile is

enforced. Refer to Section “aa-enforce—Entering Enforce Mode” (page 300) for detailed information about this tool.

Once a profile has been built and is loaded, there are two ways in which it can get processed:

`aa-complain / complain`

In complain mode, violations of AppArmor profile rules, such as the profiled program accessing files not permitted by the profile, are detected. The violations are permitted, but also logged. To improve the profile, turn complain mode on, run the program through a suite of tests to generate log events that characterize the program's access needs, then postprocess the log with the AppArmor tools (YaST or `aa-log-prof`) to transform log events into improved profiles.

`aa-enforce / enforce`

In enforce mode, violations of AppArmor profile rules, such as the profiled program accessing files not permitted by the profile, are detected. The violations are logged and not permitted. The default is for enforce mode to be enabled. To log the violations only, but still permit them, use complain mode. Enforce toggles with complain mode.

20.2 Determining Programs to Immunize

Now that you have familiarized yourself with AppArmor, start selecting the applications for which to build profiles. Programs that need profiling are those that mediate privilege. The following programs have access to resources that the person using the program does not have, so they grant the privilege to the user when used:

`cron` Jobs

Programs that are run periodically by cron. Such programs read input from a variety of sources and can run with special privileges, sometimes with as much as `root` privilege. For example, cron can run `/usr/sbin/logrotate` daily to rotate, compress, or even mail system logs. For instructions for finding these types of programs, refer to Section 20.3, “Immunizing cron Jobs” (page 237).

Web Applications

Programs that can be invoked through a Web browser, including CGI Perl scripts, PHP pages, and more complex Web applications. For instructions for finding these types of programs, refer to Section 20.4.1, “Immunizing Web Applications” (page 240).

Network Agents

Programs (servers and clients) that have open network ports. User clients, such as mail clients and Web browsers mediate privilege. These programs run with the privilege to write to the user's home directory and they process input from potentially hostile remote sources, such as hostile Web sites and e-mailed malicious code. For instructions for finding these types of programs, refer to Section 20.4.2, “Immunizing Network Agents” (page 242).

Conversely, unprivileged programs do not need to be profiled. For instance, a shell script might invoke the `cp` program to copy a file. Because `cp` does not have its own profile, it inherits the profile of the parent shell script, so can copy any files that the parent shell script's profile can read and write.

20.3 Immunizing cron Jobs

To find programs that are run by cron, inspect your local cron configuration. Unfortunately, cron configuration is rather complex, so there are numerous files to inspect. Periodic cron jobs are run from these files:

```
/etc/crontab
/etc/cron.d/*
/etc/cron.daily/*
/etc/cron.hourly/*
/etc/cron.monthly/*
/etc/cron.weekly/*
```

For `root`'s cron jobs, edit the tasks with `crontab -e` and list `root`'s cron tasks with `crontab -l`. You must be `root` for these to work.

Once you find these programs, you can use the *Add Profile Wizard* to create profiles for them. Refer to Section 23.1, “Adding a Profile Using the Wizard” (page 273).

20.4 Immunizing Network Applications

An automated method for finding network server daemons that should be profiled is to use the `aa-unconfined` tool. You can also simply view a report of this information in the YaST module (refer to Section “Application Audit Report” (page 343) for instructions).

The `aa-unconfined` tool uses the command `netstat -nlp` to inspect your open ports from inside your computer, detect the programs associated with those ports, and inspect the set of Novell AppArmor profiles that you have loaded. `aa-unconfined` then reports these programs along with the Novell AppArmor profile associated with each program, or reports “none” (if the program is not confined).

NOTE

If you create a new profile, you must restart the program that has been profiled to have it be effectively confined by AppArmor.

Below is a sample `aa-unconfined` output:

```
2325 /sbin/portmap not confined
3702❶ /usr/sbin/sshd❷ confined
    by '/usr/sbin/sshd❸ (enforce) '
4040 /usr/sbin/ntpd confined by '/usr/sbin/ntpd (enforce) '
4373 /usr/lib/postfix/master confined by '/usr/lib/postfix/master (enforce) '

4505 /usr/sbin/httpd2-prefork confined by '/usr/sbin/httpd2-prefork (enforce) '
5274 /sbin/dhccpd not confined
5592 /usr/bin/ssh not confined
7146 /usr/sbin/cupsd confined by '/usr/sbin/cupsd (complain) '
```

- ❶ The first portion is a number. This number is the process ID number (PID) of the listening program.
- ❷ The second portion is a string that represents the absolute path of the listening program
- ❸ The final portion indicates the profile confining the program, if any.

NOTE

`aa-unconfined` requires `root` privileges and should not be run from a shell that is confined by an AppArmor profile.

`aa-unconfined` does not distinguish between one network interface and another, so it reports all unconfined processes, even those that might be listening to an internal LAN interface.

Finding user network client applications is dependent on your user preferences. The `aa-unconfined` tool detects and reports network ports opened by client applications, but only those client applications that are running at the time the `aa-unconfined` analysis is performed. This is a problem because network services tend to be running all the time, while network client applications tend only to be running when the user is interested in them.

Applying Novell AppArmor profiles to user network client applications is also dependent on user preferences. Therefore, we leave the profiling of user network client applications as an exercise for the user.

To aggressively confine desktop applications, the `aa-unconfined` command supports a `paranoid` option, which reports all processes running and the corresponding AppArmor profiles that might or might not be associated with each process. The user can then decide whether each of these programs needs an AppArmor profile.

If you have new or modified profiles, you can submit them to the `apparmor-general@forge.novell.com` [<mailto:apparmor-general@forge.novell.com>] mailing list along with a use case for the application behavior that you exercised. The AppArmor team reviews and may submit the work into SUSE Linux Enterprise Server. We cannot guarantee that every profile will be included, but we make a sincere effort to include as much as possible so that end users can contribute to the security profiles that ship in SUSE Linux Enterprise Server.

Alternatively, use the AppArmor profile repository to make your profiles available to other users and to download profiles created by other AppArmor users and the AppArmor developers. Refer to Section 22.2, “Using the External Repository” (page 268) for more information on how to use the AppArmor profile repository.

20.4.1 Immunizing Web Applications

To find Web applications, investigate your Web server configuration. The Apache Web server is highly configurable and Web applications can be stored in many directories, depending on your local configuration. SUSE Linux Enterprise Server, by default, stores Web applications in `/srv/www/cgi-bin/`. To the maximum extent possible, each Web application should have an Novell AppArmor profile.

Once you find these programs, you can use the AppArmor *Add Profile Wizard* to create profiles for them. Refer to Section 23.1, “Adding a Profile Using the Wizard” (page 273).

Because CGI programs are executed by the Apache Web server, the profile for Apache itself, `usr.sbin.httpd2-prefork` for Apache2 on SUSE Linux Enterprise Server, must be modified to add execute permissions to each of these programs. For instance, adding the line `/srv/www/cgi-bin/my_hit_counter.pl rpx` grants Apache permission to execute the Perl script `my_hit_counter.pl` and requires that there be a dedicated profile for `my_hit_counter.pl`. If `my_hit_counter.pl` does not have a dedicated profile associated with it, the rule should say `/srv/www/cgi-bin/my_hit_counter.pl rix` to cause `my_hit_counter.pl` to inherit the `usr.sbin.httpd2-prefork` profile.

Some users might find it inconvenient to specify execute permission for every CGI script that Apache might invoke. Instead, the administrator can grant controlled access to collections of CGI scripts. For instance, adding the line `/srv/www/cgi-bin/*.{pl,py,pyc} rix` allows Apache to execute all files in `/srv/www/cgi-bin/` ending in `.pl` (Perl scripts) and `.py` or `.pyc` (Python scripts). As above, the `ix` part of the rule causes Python scripts to inherit the Apache profile, which is appropriate if you do not want to write individual profiles for each Python script.

NOTE

If you want the subprocess confinement module (`apache2-mod-apparmor`) functionality when Web applications handle Apache modules (`mod_perl` and `mod_php`), use the ChangeHat features when you add a profile in YaST or at the command line. To take advantage of the subprocess confinement, refer to Section 25.1, “Apache ChangeHat” (page 320).

Profiling Web applications that use `mod_perl` and `mod_php` requires slightly different handling. In this case, the “program” is a script interpreted directly by the module within the Apache process, so no `exec` happens. Instead, the Novell AppArmor version of Apache calls `change_hat()` using a subprofile (a “hat”) corresponding to the name of the URI requested.

NOTE

The name presented for the script to execute might not be the URI, depending on how Apache has been configured for where to look for module scripts. If you have configured your Apache to place scripts in a different place, the different names appear in log file when Novell AppArmor complains about access violations. See Chapter 27, *Managing Profiled Applications* (page 333).

For `mod_perl` and `mod_php` scripts, this is the name of the Perl script or the PHP page requested. For example, adding this subprofile allows the `localtime.php` page to execute and access the local system time:

```
/usr/bin/httpd2-prefork {
# ...
^/cgi-bin/localtime.php {
    /etc/localtime          r,
    /srv/www/cgi-bin/localtime.php  r,
    /usr/lib/locale/**      r,
}
}
```

If no subprofile has been defined, the Novell AppArmor version of Apache applies the `DEFAULT_URI` hat. This subprofile is basically sufficient to display an HTML Web page. The `DEFAULT_URI` hat that Novell AppArmor provides by default is the following:

```
^DEFAULT_URI {
    /usr/sbin/suexec2          mixr,
    /var/log/apache2/**        rwl,
    @{HOME}/public_html       r,
    @{HOME}/public_html/**    r,
    /srv/www/htdocs           r,
    /srv/www/htdocs/**        r,
    /srv/www/icons/*.{gif,jpg,png}  r,
    /srv/www/vhosts           r,
    /srv/www/vhosts/**        r,
    /usr/share/apache2/**      r,
    /var/lib/php/sess_*        rwl }
}
```

To use a single Novell AppArmor profile for all Web pages and CGI scripts served by Apache, a good approach is to edit the `DEFAULT_URI` subprofile.

20.4.2 Immunizing Network Agents

To find network server daemons and network clients (such as fetchmail, Firefox, amaroK or Banshee) that need to be profiled, you should inspect the open ports on your machine, consider the programs that are answering on those ports, and provide profiles for as many of those programs as possible. If you provide profiles for all programs with open network ports, an attacker cannot get to the file system on your machine without passing through a Novell AppArmor profile policy.

Scan your server for open network ports manually from outside the machine using a scanner (such as nmap), or from inside the machine using the `netstat --inet -n -p` command. Then, inspect the machine to determine which programs are answering on the discovered open ports.

TIP

Refer to the man page of the `netstat` command for a detailed reference of all possible options.

Profile Components and Syntax

21

Building AppArmor profiles to confine an application is very straightforward and intuitive. AppArmor ships with several tools that assist in profile creation. It does not require you to do any programming or script handling. The only task that is required of the administrator is to determine a policy of strictest access and execute permissions for each application that needs to be hardened.

Updates or modifications to the application profiles are only required if the software configuration or the desired range of activities changes. AppArmor offers intuitive tools to handle profile updates and modifications.

You are ready to build Novell AppArmor profiles after you select the programs to profile. To do so, it is important to understand the components and syntax of profiles. AppArmor profiles contain several building blocks that help build simple and reusable profile code:

`#include` Files

`#include` statements are used to pull in parts of other AppArmor profiles to simplify the structure of new profiles.

Abstractions

Abstractions are `#include` statements grouped by common application tasks.

Program Chunks

Program chunks are `#include` statements that contain chunks of profiles that are specific to program suites.

Capability Entries

Capability entries are profile entries for any of the POSIX.1e Linux capabilities allowing a fine-grained control over what a confined process is allowed to do through system calls that require privileges.

Network Access Control Entries

Network Access Control Entries mediate network access based on the address type and family.

Local Variable Definitions

Local variables define shortcuts for paths.

File Access Control Entries

File Access Control Entries specify the set of files an application can access.

rlimit Entries

rlimit entries set and control an application's resource limits.

For help determining the programs to profile, refer to Section 20.2, “Determining Programs to Immunize” (page 236). To start building AppArmor profiles with YaST, proceed to Chapter 23, *Building and Managing Profiles with YaST* (page 271). To build profiles using the AppArmor command line interface, proceed to Chapter 24, *Building Profiles from the Command Line* (page 291).

21.1 Breaking a Novell AppArmor Profile into Its Parts

The easiest way of explaining what a profile consists of and how to create one is to show the details of a sample profile, in this case for a hypothetical application called

```
/usr/bin/foo:
```

```
#include <tunables/global>❶

# a comment naming the application to confine
/usr/bin/foo❷
{❸
    #include <abstractions/base>❹

    capability setgid❺,
    network inet tcp❻,
```

```

link /etc/sysconfig/foo -> /etc/foo.conf, ❶
/bin/mount                ux,
/dev/{,u}random           r, ❷
/etc/ld.so.cache          r,
/etc/foo/*                 r,
/lib/ld-*.so*             mr,
/lib/lib*.so*            mr,
/proc/[0-9]**            r,
/usr/lib/**               mr,
/tmp/❸                   r,
/tmp/foo.pid              wr,
/tmp/foo.*                lrw,
/~/❹/.foo_file           rw,
/~/foo_lock               kw,
owner❺ /shared/foo/**    rw,
/usr/bin/foobar           cx,❻
/bin/**                   px -> bin_generic,❼

# a comment about foo's local (children)profile for /usr/bin/foobar.

profile /usr/bin/foobar❸ {
    /bin/bash              rmix,
    /bin/cat               rmix,
    /bin/more              rmix,
    /var/log/foobar*       rwl,
    /etc/foobar            r,
}

# foo's hat, bar.
^bar❸ {
    /lib/ld-*.so*         mr,
    /usr/bin/bar          px,
    /var/spool/*          rwl,
}

```

- ❶ This loads a file containing variable definitions.
- ❷ The normalized path to the program that is confined.
- ❸ The curly braces ({ }) serve as a container for include statements, subprofiles, path entries, capability entries, and network entries.
- ❹ This directive pulls in components of AppArmor profiles to simplify profiles.
- ❺ Capability entry statements enable each of the 29 POSIX.1e draft capabilities.
- ❻ A directive determining the kind of network access allowed to the application. For details, refer to Section 21.5, “Network Access Control” (page 251).

- ⑦ A link pair rule specifying the source and the target of a link. See Section 21.7.6, “Link Pair” (page 256) for more information.
- ⑧ The curly braces ({ }) make this rule apply to the path both with and without the content enclosed by the braces.
- ⑨ A path entry specifying what areas of the file system the program can access. The first part of a path entry specifies the absolute path of a file (including regular expression globbing) and the second part indicates permissible access modes (for example `r` for read, `w` for write, and `x` for execute). A whitespace of any kind (spaces or tabs) can precede pathnames or separate the pathname from the access modes. Spaces between the access mode and the trailing comma are optional. Find a comprehensive overview of the available access modes in Section 21.7, “File Permission Access Modes” (page 255).
- ⑩ This variable expands to a value that can be changed without changing the entire profile.
- ⑪ An owner conditional rule, granting read and write permission on files owned by the user. Refer to Section 21.7.7, “Owner Conditional Rules” (page 257) for more information.
- ⑫ This entry defines a transition to the local profile `/usr/bin/foobar`. Find a comprehensive overview of the available execute modes in Section 21.8, “Execute Modes” (page 258).
- ⑬ A named profile transition to the profile `bin_generic` located in the global scope. See Section 21.8.7, “Named Profile Transitions” (page 260) for details.
- ⑭ The local profile `/usr/bin/foobar` is defined in this section.
- ⑮ This section references a “hat” subprofile of the application. For more details on AppArmor's ChangeHat feature, refer to Chapter 25, *Profiling Your Web Applications Using ChangeHat* (page 319).

When a profile is created for a program, the program can access only the files, modes, and POSIX capabilities specified in the profile. These restrictions are in addition to the native Linux access controls.

Example: To gain the capability `CAP_CHOWN`, the program must have both access to `CAP_CHOWN` under conventional Linux access controls (typically, be a `root`-owned process) and have the capability `chown` in its profile. Similarly, to be able to write to the file `/foo/bar` the program must have both the correct user ID and mode bits set

in the files attributes (see the `chmod` and `chown` man pages) and have `/foo/bar` w in its profile.

Attempts to violate Novell AppArmor rules are recorded in `/var/log/audit/audit.log` if the `audit` package is installed or otherwise in `/var/log/messages`. In many cases, Novell AppArmor rules prevent an attack from working because necessary files are not accessible and, in all cases, Novell AppArmor confinement restricts the damage that the attacker can do to the set of files permitted by Novell AppArmor.

21.2 Profile Types

AppArmor knows four different types of profiles: standard profiles, unattached profiles, local profiles and hats. Standard and unattached profiles are stand-alone profiles, each stored in a file under `/etc/apparmor.d/`. Local profiles and hats are children profiles embedded inside of a parent profile used to provide tighter or alternate confinement for a subtask of an application.

21.2.1 Standard Profiles

The default AppArmor profile is attached to a program by its name, so a profile name must match the path to the application it is to confine.

```
/usr/bin/foo {  
...  
}
```

This profile will be automatically used whenever an unconfined process executes `/usr/bin/foo`.

21.2.2 Unattached Profiles

Unattached profiles do not reside in the file system namespace and therefore are not automatically attached to an application. The name of an unattached profile is preceded by the keyword `profile`. You can freely choose a profile name, except for the following limitations: the name must not begin with a `:` or `.` character. If it contains a whitespace, it must be quoted. If the name begins with a `/`, the profile is considered to be a standard profile, so the following two profiles are identical:

```
profile /usr/bin/foo {
...
}
/usr/bin/foo {
...
}
```

Unattached profiles are never used automatically, nor can they be transitioned to through a `px` rule. They need to be attached to a program by either using a named profile transition (see Section 21.8.7, “Named Profile Transitions” (page 260)) or with the `change_profile` rule (see Section 21.2.5, “Change rules” (page 249)).

Unattached profiles are useful for specialized profiles for system utilities that generally should not be confined by a system wide profile (for example, `/bin/bash`). They can also be used to set up roles or to confine a user.

21.2.3 Local Profiles

Local profiles provide a convenient way to provide specialized confinement for utility programs launched by a confined application. They are specified just like standard profiles except they are embedded in a parent profile and begin with the `profile` keyword:

```
/parent/profile {
...
  profile local/profile {
    ...
  }
}
```

To transition to a local profile, either use a `cx` rule (see Section 21.8.2, “Discrete Local Profile Execute Mode (cx)” (page 258)) or a named profile transition (see Section 21.8.7, “Named Profile Transitions” (page 260)).

21.2.4 Hats

AppArmor "hats" are a local profiles with some additional restrictions and an implicit rule allowing for `change_hat` to be used to transition to them. Refer to Chapter 25, *Profiling Your Web Applications Using ChangeHat* (page 319) for a detailed description.

21.2.5 Change rules

AppArmor provides `change_hat` and `change_profile` rules that control domain transitioning. `change_hat` are specified by defining hats in a profile, while `change_profile` rules refer to another profile and start with the keyword `change_profile`:

```
change_profile /usr/bin/foobar,
```

Both `change_hat` and `change_profile` provide for an application directed profile transition, without having to launch a separate application. `change_profile` provides a generic one way transition between any of the loaded profiles. `change_hat` provides for a returnable parent child transition where an application can switch from the parent profile to the hat profile and if it provides the correct secret key return to the parent profile at a later time.

`change_profile` is best used in situations where an application goes through a trusted setup phase and then can lower its privilege level. Any resources mapped or opened during the start-up phase may still be accessible after the profile change, but the new profile will restrict the opening of new resources, and will even limit some of the resources opened before the switch. Specifically, memory resources will still be available while capability and file resources (as long as they are not memory mapped) can be limited.

`change_hat` is best used in situations where an application runs a virtual machine or an interpreter that does not provide direct access to the applications resources (e.g. Apache's `mod_php`). Since `change_hat` stores the return secret key in the application's memory the phase of reduced privilege should not have direct access to memory. It is also important that file access is properly separated, since the hat can restrict accesses to a file handle but does not close it. If an application does buffering and provides access to the open files with buffering, the accesses to these files may not be seen by the kernel and hence not restricted by the new profile.

WARNING: Safety of Domain Transitions

The `change_hat` and `change_profile` domain transitions are less secure than a domain transition done through an `exec` because they do not affect a processes memory mappings, nor do they close resources that have already been opened.

21.3 #include Statements

`#include` statements are directives that pull in components of other Novell AppArmor profiles to simplify profiles. Include files retrieve access permissions for programs. By using an include, you can give the program access to directory paths or files that are also required by other programs. Using includes can reduce the size of a profile.

By default, AppArmor adds `/etc/apparmor.d` to the path in the `#include` statement. AppArmor expects the include files to be located in `/etc/apparmor.d`. Unlike other profile statements (but similar to C programs), `#include` lines do not end with a comma.

To assist you in profiling your applications, Novell AppArmor provides three classes of `#includes`: abstractions, program chunks and tunables.

21.3.1 Abstractions

Abstractions are `#includes` that are grouped by common application tasks. These tasks include access to authentication mechanisms, access to name service routines, common graphics requirements, and system accounting. Files listed in these abstractions are specific to the named task. Programs that require one of these files usually require some of the other files listed in the abstraction file (depending on the local configuration as well as the specific requirements of the program). Find abstractions in `/etc/apparmor.d/abstractions`.

21.3.2 Program Chunks

The program-chunks directory (`/etc/apparmor.d/program-chunks`) contains some chunks of profiles that are specific to program suites and not generally useful outside of the suite, thus are never suggested for use in profiles by the profile wizards (`aa-logprof` and `aa-genprof`). Currently, program chunks are only available for the postfix program suite.

21.3.3 Tunables

The tunables directory (`/etc/apparmor.d/tunables`) contains global variable definitions. When used in a profile, these variables expand to a value that can be changed without changing the entire profile. Add all the tunables definitions that should be available to every profile to `/etc/apparmor.d/tunables/global`.

21.4 Capability Entries (POSIX.1e)

Capability statements are simply the word `capability` followed by the name of the POSIX.1e capability as defined in the `capabilities(7)` man page.

21.5 Network Access Control

AppArmor allows mediation of network access based on the address type and family. The following illustrates the network access rule syntax:

```
network [[<domain>❶][<type>❷][<protocol>❸]]
```

- ❶ Supported domains: `inet`, `ax25`, `ipx`, `appletalk`, `netrom`, `bridge`, `x25`, `inet6`, `rose`, `netbeui`, `security`, `key`, `packet`, `ash`, `econet`, `atmsvc`, `sna`, `irda`, `pppox`, `wanpipe`, `bluetooth`
- ❷ Supported types: `stream`, `dgram`, `seqpacket`, `rdm`, `raw`, `packet`
- ❸ Supported protocols: `tcp`, `udp`, `icmp`

The AppArmor tools support only family and type specification. The AppArmor module emits only `network domain type` in “access denied” messages. And only these are output by the profile generation tools, both YaST and command line.

The following examples illustrate possible network-related rules to be used in AppArmor profiles. Note that the syntax of the last two are not currently supported by the AppArmor tools.

```
network❶,  
network inet❷,  
network inet6❸,  
network inet stream❹,  
network inet tcp❺,  
network tcp❻,
```

- ❶ Allow all networking. No restrictions applied with regards to domain, type, or protocol.
- ❷ Allow general use of IPv4 networking.
- ❸ Allow general use of IPv6 networking.
- ❹ Allow the use of IPv4 TCP networking.
- ❺ Allow the use of IPv4 TCP networking, paraphrasing the rule above.
- ❻ Allow the use of both IPv4 and IPv6 TCP networking.

21.6 Paths and Globbing

AppArmor explicitly distinguishes directory path names from file path names. Use a trailing `/` for any directory path that needs to be explicitly distinguished:

```
/some/random/example/* r
```

Allow read access to files in the `/some/random/example` directory.

```
/some/random/example/ r
```

Allow read access to the directory only.

```
/some/**/ r
```

Give read access to any directories below `/some`.

```
/some/random/example/** r
```

Give read access to files and directories under `/some/random/example`.

```
/some/random/example/**[^/] r
```

Give read access to files under `/some/random/example`. Explicitly exclude directories (`[^/]`).

Globbering (or regular expression matching) is when you modify the directory path using wild cards to include a group of files or subdirectories. File resources can be specified with a globbing syntax similar to that used by popular shells, such as `csh`, `Bash`, and `zsh`.

<code>*</code>	Substitutes for any number of any characters, except <code>/</code> . Example: An arbitrary number of file path elements.
<code>**</code>	Substitutes for any number of characters, including <code>/</code> . Example: An arbitrary number of path elements, including entire directories.
<code>?</code>	Substitutes for any single character, except <code>/</code> .
<code>[abc]</code>	Substitutes for the single character <code>a</code> , <code>b</code> , or <code>c</code> . Example: a rule that matches <code>/home[01]/*/.plan</code> allows a program to access <code>.plan</code> files for users in both <code>/home0</code> and <code>/home1</code> .
<code>[a-c]</code>	Substitutes for the single character <code>a</code> , <code>b</code> , or <code>c</code> .
<code>{ab, cd}</code>	Expands to one rule to match <code>ab</code> and one rule to match <code>cd</code> . Example: a rule that matches <code>{usr, www}/pages/**</code> grants access to Web pages in both <code>/usr/pages</code> and <code>/www/pages</code> .
<code>[^a]</code>	Substitutes for any character except <code>a</code> .

21.6.1 Using Variables in Profiles

AppArmor allows to use variables holding paths in profiles. Use global variables to make your profiles portable and local variables to create shortcuts for paths.

A typical example of when global variables come in handy are network scenarios in which user home directories are mounted in different locations. Instead of rewriting

paths to home directories in all affected profiles, you only need to change the value of a variable. Global variables are defined under `/etc/apparmor.d/tunables` and have to be made available via an `#include` statement. Find the variable definitions for this use case (`@{HOME}` and `@{HOMEDIRS}`) in the `/etc/apparmor.d/tunables/home` file.

Local variables are defined at the head of a profile. This is useful to provide the base of for a chrooted path, for example:

```
@{CHROOT_BASE}=/tmp/foo
/sbin/syslog-ng {
...
# chrooted applications
@{CHROOT_BASE}/var/lib/*/dev/log w,
@{CHROOT_BASE}/var/log/** w,
...
}
```

NOTE

With the current AppArmor tools, variables can only be used when manually editing and maintaining a profile.

21.6.2 Alias rules

Alias rules provide an alternative way to manipulate profile path mappings to site specific layouts. They are an alternative form of path rewriting to using variables, and are done post variable resolution:

```
alias /home/ -> /mnt/users/
```

NOTE

With the current AppArmor tools, alias rules can only be used when manually editing and maintaining a profile. Whats more, they are deactivated by disabled. Enable alias rules by editing `/etc/apparmor.d/tunables/alias`

21.7 File Permission Access Modes

File permission access modes consist of combinations of the following modes:

r	Read mode
w	Write mode (mutually exclusive to a)
a	Append mode (mutually exclusive to w)
k	File locking mode
l	Link mode
<code>link file -> target</code>	Link pair rule (cannot be combined with other access modes)

21.7.1 Read Mode (r)

Allows the program to have read access to the resource. Read access is required for shell scripts and other interpreted content and determines if an executing process can core dump.

21.7.2 Write Mode (w)

Allows the program to have write access to the resource. Files must have this permission if they are to be unlinked (removed).

21.7.3 Append Mode (a)

Allows a program to write to the end of a file. In contrast to the w mode, the append mode does not include the ability to overwrite data, to rename, or to remove a file. The append permission is typically used with applications who need to be able to write to log files, but which should not be able to manipulate any existing data in the log files.

As the append permission is just a subset of the permissions associated with the write mode, the `w` and `a` permission flags cannot be used together and are mutually exclusive.

21.7.4 File Locking Mode (k)

The application can take file locks. Former versions of AppArmor allowed files to be locked if an application had access to them. By using a separate file locking mode, AppArmor makes sure locking is restricted only to those files which need file locking and tightens security as locking can be used in several denial of service attack scenarios.

21.7.5 Link Mode (l)

The link mode mediates access to hard links. When a link is created, the target file must have the same access permissions as the link created (with the exception that the destination does not need link access).

21.7.6 Link Pair

The link mode grants permission to create links to arbitrary files, provided the link has a subset of the permissions granted by the target (subset permission test). By specifying origin and destination, the link pair rule provides greater control over how hard links are created. Link pair rules by default do not enforce the link subset permission test that the standard rules link permission requires. To force the rule to require the test the `subset` keyword is used. The following rules are equivalent:

```
/link    l,  
link subset /link -> /**,
```

NOTE

Currently link pair rules are not supported by YaST and the command line tools. Manually edit your profiles to use them. Updating such profiles using the tools is safe, because the link pair entries will not be touched.

21.7.7 Owner Conditional Rules

The file rules can be extended so that they can be conditional upon the the user being the owner of the file (the fsuid has to match the file's uid). For this purpose the `owner` keyword is prepended to the rule. Owner conditional rules accumulate just as regular file rules.

```
owner /home/*/** rw
```

When using file ownership conditions with link rules the ownership test is done against the target file so the user must own the file to be able to link to it.

NOTE: Precedence of Regular File Rules

Owner conditional rules are considered a subset of regular file rules. If a regular file rule overlaps with an owner conditional file rule, the resultant permissions will be that of the regular file rule.

21.7.8 Deny Rules

Deny rules can be used to annotate or quiet known rejects. The profile generating tools will not ask about a known reject treated with a deny rule. Such a reject will also not show up in the audit logs when denied, keeping the log files lean. If this is not desired, prepend the deny entry with the keyword `audit`.

It is also possible to use deny rules in combination with allow rules. This allows you to specify a broad allow rule, and then subtract a few known files that should not be allowed. Deny rules can also be combined with owner rules, to deny files owned by the user. The following example allows read/write access to everything in a users directory except write access to the `.ssh/` files:

```
deny /home/*/.ssh/** w,  
/home/*/** rw,
```

The extensive use of deny rules is generally not encouraged, because it makes it much harder to understand what a profile does. However a judicious use of deny rules can simplify profiles. Therefore the tools only generate profiles denying specific files and will not make use of globbing in deny rules. Manually edit your profiles to add deny rules using globbing. Updating such profiles using the tools is safe, because the deny entries will not be touched.

21.8 Execute Modes

Execute modes, also named profile transitions, consist of the following modes:

<code>px</code>	Discrete profile execute mode
<code>cx</code>	Discrete local profile execute mode
<code>ux</code>	Unconstrained execute mode
<code>ix</code>	Inherit execute mode
<code>m</code>	Allow <code>PROT_EXEC</code> with <code>mmap(2)</code> calls

21.8.1 Discrete Profile Execute Mode (px)

This mode requires that a discrete security profile is defined for a resource executed at an AppArmor domain transition. If there is no profile defined, the access is denied.

WARNING: Using the Discrete Profile Execute Mode

`px` does not scrub the environment of variables such as `LD_PRELOAD`. As a result, the calling domain may have an undue amount of influence over the called item.

Incompatible with `Ux`, `ux`, `Px`, and `ix`.

21.8.2 Discrete Local Profile Execute Mode (cx)

As `px`, but instead of searching the global profile set, `cx` only searches the local profiles of the current profile. This profile transition provides a way for an application to have alternate profiles for helper applications.

NOTE: Limitations of the Discrete Local Profile Execute Mode (cx)

Currently, cx transitions are limited to top level profiles and can not be used in hats and children profiles. This restriction will be removed in the future.

Incompatible with Ux, ux, Px, px, Cx, and ix.

21.8.3 Unconstrained Execute Mode (ux)

Allows the program to execute the resource without any AppArmor profile applied to the executed resource. This mode is useful when a confined program needs to be able to perform a privileged operation, such as rebooting the machine. By placing the privileged section in another executable and granting unconstrained execution rights, it is possible to bypass the mandatory constraints imposed on all confined processes. For more information about what is constrained, see the `apparmor(7)` man page.

WARNING: Using Unconstrained Execute Mode (ux)

Use ux only in very special cases. It enables the designated child processes to be run without any AppArmor protection. ux does not scrub the environment of variables such as LD_PRELOAD. As a result, the calling domain may have an undue amount of influence over the called resource. Use this mode only if the child absolutely must be run unconfined and LD_PRELOAD must be used. Any profile using this mode provides negligible security. Use at your own risk.

This mode is incompatible with Ux, px, Px, and ix.

21.8.4 Clean Exec modes

The clean exec modes allow the named program to run in px, cx and ux mode, but AppArmor invokes the Linux kernel's `unsafe_exec` routines to scrub the environment, similar to `setuid` programs. The clean exec modes are specified with an uppercase letter: Px, Cx and Ux. See the man page of `ld.so(8)` for some information about `setuid` and `setgid` environment scrubbing.

21.8.5 Inherit Execute Mode (ix)

`ix` prevents the normal AppArmor domain transition on `execve(2)` when the profiled program executes the named program. Instead, the executed resource inherits the current profile.

This mode is useful when a confined program needs to call another confined program without gaining the permissions of the target's profile or losing the permissions of the current profile. There is no version to scrub the environment because `ix` executions do not change privileges.

Incompatible with `cx`, `ux`, and `px`. Implies `m`.

21.8.6 Allow Executable Mapping (m)

This mode allows a file to be mapped into memory using `mmap(2)`'s `PROT_EXEC` flag. This flag marks the pages executable. It is used on some architectures to provide non executable data pages, which can complicate exploit attempts. AppArmor uses this mode to limit which files a well-behaved program (or all programs on architectures that enforce non executable memory access controls) may use as libraries, to limit the effect of invalid `-L` flags given to `ld(1)` and `LD_PRELOAD`, `LD_LIBRARY_PATH`, given to `ld.so(8)`.

21.8.7 Named Profile Transitions

By default, the `px` and `cx` (and their clean exec variants, too) transition to a profile who's name matches the executable name. With named profile transitions, you can specify a profile to be transitioned to. This is useful if multiple binaries need to share a single profile, or if they need to use a different profile than their name would specify. Named profile transitions can be used in conjunction with `cx`, `Cx`, `px` and `Px`. Currently there is a limit of twelve named profile transitions per profile.

Named profile transitions use `->` to indicate the name of the profile that needs to be transitioned to:

```
/usr/bin/foo
{
    /bin/** px -> shared_profile,
```

```
...
/usr/*bash cx -> local_profile,
...
profile local_profile
{
  ...
}
}
```

NOTE: Difference Between Normal and Named Transitions

When used with globbing, normal transitions provide a “one to many” relationship—`/bin/** px` will transition to `/bin/ping`, `/bin/cat`, etc, depending on the program being run.

Named transitions provide a “many to one” relationship—all programs that match the rule regardless of their name will transition to the specified profile.

Named profile transitions show up in the log as having the mode `Nx`. The name of the profile to be changed to is listed in the `name2` field.

21.8.8 Inheritance Fallback for Profile Transitions

The `px` and `cx` transitions specify a hard dependency (if the specified profile does not exist, the exec will fail). With the inheritance fallback, the execution will succeed but inherit the current profile. To specify inheritance fallback, `ix` is combined with `cx`, `Cx`, `px` and `Px` into the modes `cix`, `Cix`, `pix` and `Pix`. The fallback modes can be used with named profile transitions, too.

21.8.9 Variable Settings in Execution Modes

When choosing one of the `Px`, `Cx` or `Ux` execution modes, take into account that the following environment variables are removed from the environment before the child process inherits it. As a consequence, applications or processes relying on any of these variables do not work anymore if the profile applied to them carries `Px`, `Cx` or `Ux` flags:

- GCONV_PATH
- GETCONF_DIR
- HOSTALIASES
- LD_AUDIT
- LD_DEBUG
- LD_DEBUG_OUTPUT
- LD_DYNAMIC_WEAK
- LD_LIBRARY_PATH
- LD_ORIGIN_PATH
- LD_PRELOAD
- LD_PROFILE
- LD_SHOW_AUXV
- LD_USE_LOAD_BIAS
- LOCALDOMAIN
- LOCPATH
- MALLOC_TRACE
- NLSPATH
- RESOLV_HOST_CONF
- RES_OPTIONS
- TMPDIR
- TZDIR

21.9 Resource Limit Control

AppArmor provides the ability to set and control an application's resource limits (rlimits, also known as ulimits). By default AppArmor does not control applications rlimits, and it will only control those limits specified in the confining profile. For more information about resource limits, refer to the `setrlimit(2)`, `ulimit(1)`, or `ulimit(3)` man pages.

AppArmor leverages the system's rlimits and as such does not provide an additional auditing that would normally occur. It also cannot raise rlimits set by the system, AppArmor rlimits can only reduce an application's current resource limits.

The values will be inherited by the children of a process and will remain even if a new profile is transitioned to or the application becomes unconfined. So when an application transitions to a new profile, that profile has the ability to further reduce the applications rlimits.

AppArmor's rlimit rules will also provide mediation of setting an application's hard limits, should it try to raise them. The application will not be able to raise its hard limits any further than specified in the profile. The mediation of raising hard limits is not inherited as the set value is, so that once the application transitions to a new profile it is free to raise its limits as specified in the profile.

AppArmor's rlimit control does not affect an application's soft limits beyond ensuring that they are less than or equal to the application's hard limits.

AppArmor's hard limit rules have the general form of:

```
set rlimit resource <= value,
```

where *resource* and *value* are to be replaced with the following values:

cpu

currently not supported

fsize, data, stack, core, rss, as, memlock, msgqueue

a number in bytes, or a number with a suffix where the suffix can be K (kilobytes), M (megabytes), G (gigabytes), for example

```
rlimit data <= 100M,
```

`fsize, nofile, locks, sigpending, nproc*, rtprio`
a number greater or equal to 0

`nice`
a value between -20 and 19

*The `nproc` rlimit is handled different than all the other rlimits. Instead of indicating the standard process rlimit it controls the maximum number of processes that can be running under the profile at any given time. Once the limit is exceeded the creation of new processes under the profile will fail until the number of currently running processes is reduced.

NOTE

Currently the tools can not be used to add rlimit rules to profiles. The only way to add rlimit controls to a profile is to manually edit the profile with a text editor. The tools will still work with profiles containing rlimit rules and will not remove them, so it is safe to use the tools to update profiles containing them.

21.10 Auditing Rules

AppArmor provides the ability to audit given rules so that when they are matched an audit message will appear in the audit log. To enable audit messages for a given rule, the `audit` keyword is prepended to the rule:

```
audit /etc/foo/*          rw,
```

If it is desirable to audit only a given permission the rule can be split into two rules. The following example will result in audit messages when files are opened for writing, but not when they are opened for just reading:

```
audit /etc/foo/*  w,  
/etc/foo/*       r,
```

NOTE

Audit messages are not generated for every read or write of a file but only when a file is opened for read or write.

Audit control can be combined with owner conditional file rules to provide auditing when users access files they own (at the moment it is not possible to audit files they don't own):

```
audit owner /home/*/.ssh/**          rw,
```

21.11 Setting Capabilities per Profile

Normally AppArmor only restricts existing native Linux controls and does not grant additional privileges. Therefore a program, having been granted write access to a file via its profile, would not be able to actually write to this file as long as the mode bits are set to read only.

The only exception to this strict rule is the `set capability` rule. This provides the ability to give non-root users administrative privileges, as defined in the `capabilities(7)` man page. Contrary to setting a program to `setuid` or using file system capabilities (that apply to single programs only), the `set capability` rule allows the user to apply capabilities to multiple programs running under a specific profile (by using `ix` transitions). For security reasons, `set capability` rules will not be inherited (once a program leaves the profile, it loses the elevated privilege).

WARNING: Use set capabilities Rules with Extreme Caution

Using the `set capabilities` rules allows to give processes `root` privileges. Therefore these rules should be used with extreme caution and only in exceptional cases.

To set a capability in a profile the keyword “set” is prepended to a capability rule. Setting a capability also implicitly adds a capability rule allowing that capability.

```
set capabilty cap_chown,
```

NOTE

Currently the tools can not be used to add `rlimit` rules to profiles. The only way to add `rlimit` controls to a profile is to manually edit the profile with a text editor. The tools will still work with profiles containing `rlimit` rules and will not remove them, so it is safe to use the tools to update profiles containing them.

AppArmor Profile Repositories

AppArmor ships a set of profiles enabled by default and created by the AppArmor developers, and kept under the `/etc/apparmor.d`. In addition to these profiles, SUSE Linux Enterprise Server ships profiles for individual applications together with the relevant application. These profiles are not enabled by default, and reside under another directory than the standard AppArmor profiles, `/etc/apparmor/profiles/extras`.

AppArmor also supports the use of an external profile repository. This repository is maintained by Novell and allows you to download profiles generated by Novell and other AppArmor users as well as uploading your own. Find the profile repository at <http://apparmor.opensuse.org>.

22.1 Using the Local Repository

The AppArmor tools (YaST and `aa-genprof` and `aa-logprof`) support the use of a local repository. Whenever you start to create a new profile from scratch, and there already is one inactive profile in your local repository, you are asked whether you would like to use the existing inactive one from `/etc/apparmor/profiles/extras` and whether you want to base your efforts on it. If you decide to use this profile, it gets copied over to the directory of profiles enabled by default (`/etc/apparmor.d`) and loaded whenever AppArmor is started. Any further further adjustments will be done to the active profile under `/etc/apparmor.d`.

22.2 Using the External Repository

The external AppArmor profile repository at <http://apparmor.opensuse.org> serves two main purposes: Allowing users to either browse and download profiles created by other users and uploading their profiles to be able to easily use them on different machines. A valid login on the profile repository server is required for uploading profiles. Simply downloading profiles from the server does not require a login.

NOTE: Using the AppArmor Profile Repository

When using the profile repository in your deployment, keep in mind that the profiles maintained in the repository are primarily targeted at profile developers and might probably need fine-tuning before they suit your particular needs. Please test the downloaded profiles extensively before deploying them to your live setup, and adjust them if necessary.

22.2.1 Setting up Profile Repository Support

Once properly configured, both the YaST and the command line tools support the use of an external profile repository. The initial configuration takes place when you start the YaST Add Profile Wizard, the Update Profile Wizard, `aa-genprof`, or `aa-logprof` to create or update a profile that already exists on the repository server:

- 1 Determine whether or not to use the profile repository.
- 2 Enable the repository for profile downloads.
- 3 Once you have created or modified a profile, determine whether the tools need to be able to upload your profile to the repository.

If you choose to upload profiles to the repository, enter your credentials for the repository server.

The configuration of the repository is done by editing two configuration files, `/etc/apparmor/logprof.conf` and `/etc/apparmor/respository.conf`.

The `/etc/apparmor/logprof.conf` file contains a section called `[repository].distro` determines the version of SUSE Linux Enterprise Server

used on your system for which the AppArmor tools need to search profiles on the server. `url` holds the server URL and `preferred_user` tells the AppArmor tools to prefer profiles created by the `novell` user. Those profiles were created, tested and approved by members of the SUSE development team.

```
...
[repository]
  distro      = opensuse10.3
  url         = http://apparmor.opensuse.org/backend/api
  preferred_user = novell
...
```

The `/etc/apparmor/repository.conf` file is created during the configuration process with the AppArmor tools. It contains your authentication data and specifies which actions to enable with regards to the profile repository. If you opt for profile download and do not want to be able to upload your own profiles `enabled` is set to `yes` while `upload` is set to `no`.

```
[repository]
  enabled = yes
  upload = yes
  user = tux
  pass = XXXXX
```

Once initially configured through the AppArmor tools, the configuration can only be changed manually.

22.2.2 Downloading a Profile

While creating a profile from scratch or updating an existing profile by processing reject messages in the log, the AppArmor tools search the repository for a matching profile. If the search is successful, the profile or the list of profiles is displayed and you can view them and choose the one that best matches your setup. As soon as you have chosen a profile, it gets copied to the local machine (to the `/etc/apparmor.d` directory) and activated. Alternatively, you can choose to ignore the profile on the repository and create your own one from scratch.

22.2.3 Uploading Your own Profile

After a profile has been created or updated, the AppArmor tools that a profile also present in the repository has been changed or that a new one has been created. If your system is configured to upload profiles to the repository, you are prompted to provide a ChangeLog to document your changes before the changes are uploaded to the server. These changes are only synched to the repository, but not to the creator of the original profile.

Building and Managing Profiles with YaST

23

YaST provides an easy way to build profiles and manage Novell® AppArmor. It provides two interfaces: a graphical one and a text-based one. The text-based interface consumes less resources and bandwidth, making it a better choice for remote administration, or for times when a local graphical environment is inconvenient. Although the interfaces have differing appearances, they offer the same functionality in similar ways. Another alternative is to use AppArmor commands, which can control AppArmor from a terminal window or through remote connections. The command line tools are described in Chapter 24, *Building Profiles from the Command Line* (page 291).

Start YaST from the main menu and enter your `root` password when prompted for it. Alternatively, start YaST by opening a terminal window, logging in as `root`, and entering `yast2` for the graphical mode or `yast` for the text-based mode.

Figure 23.1 *YaST Controls for AppArmor*

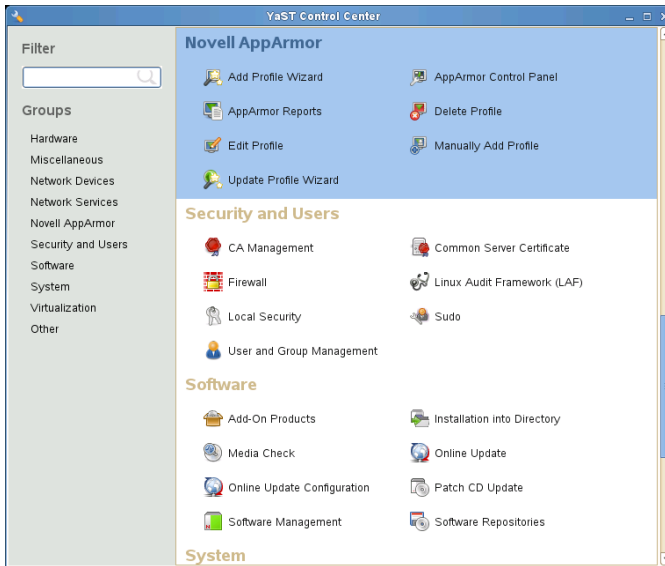

The right frame shows the AppArmor options:

Add Profile Wizard

For detailed steps, refer to Section 23.1, “Adding a Profile Using the Wizard” (page 273).

Manually Add Profile

Add a Novell AppArmor profile for an application on your system without the help of the wizard. For detailed steps, refer to Section 23.2, “Manually Adding a Profile” (page 281).

Edit Profile

Edits an existing Novell AppArmor profile on your system. For detailed steps, refer to Section 23.3, “Editing Profiles” (page 281).

Delete Profile

Deletes an existing Novell AppArmor profile from your system. For detailed steps, refer to Section 23.4, “Deleting a Profile” (page 287).

Update Profile Wizard

For detailed steps, refer to Section 23.5, “Updating Profiles from Log Entries” (page 287).

AppArmor Reports

For detailed steps, refer to Section 27.3, “Configuring Reports” (page 337).

AppArmor Control Panel

For detailed steps, refer to Section 23.6, “Managing Novell AppArmor and Security Event Status” (page 288).

23.1 Adding a Profile Using the Wizard

Add Profile Wizard is designed to set up Novell AppArmor profiles using the AppArmor profiling tools, `aa-genprof` (generate profile) and `aa-logprof` (update profiles from learning mode log file). For more information about these tools, refer to Section 24.6.3, “Summary of Profiling Tools” (page 298).

- 1 Stop the application before profiling it to ensure that application start-up is included in the profile. To do this, make sure that the application or daemon is not running.

For example, enter `rcPROGRAM stop` (or `/etc/init.d/PROGRAM stop`) in a terminal window while logged in as `root`, replacing `PROGRAM` with the name of the program to profile.

- 2 Start YaST and select *Novell AppArmor > Add Profile Wizard*.

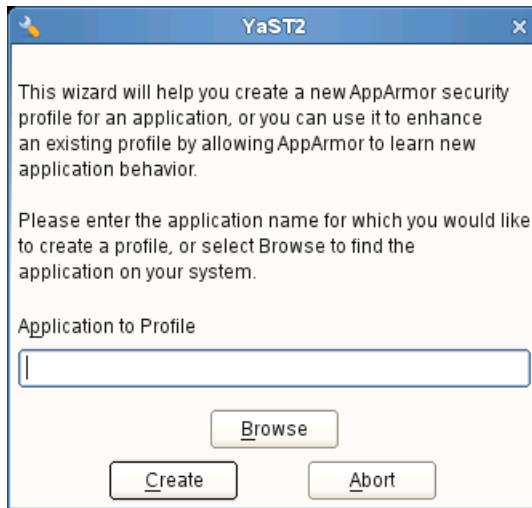

3 Enter the name of the application or browse to the location of the program.

4 Click *Create*. This runs an AppArmor tool named `aa-autodep`, which performs a static analysis of the program to profile and loads an approximate profile into the AppArmor module. For more information about `aa-autodep`, refer to Section “`aa-autodep`—Creating Approximate Profiles” (page 298).

Depending on whether the profile you are about to create already exists either in the local profile repository (see Section 22.1, “Using the Local Repository” (page 267)) or in the external profile repository (see Section 22.2, “Using the External Repository” (page 268)) or whether it does not exist yet, proceed with one of the following options:

- Determine whether you want to use or fine-tune an already existing profile from your local profile repository, as outlined in Step 5 (page 275).
- Determine whether you want to use or fine-tune an already existing profile from the external profile repository, as outlined in Step 6 (page 275).
- Create the profile from scratch and proceed with Step 7 (page 275) and beyond.

- 5** If the profile already exists in the local profile repository under `/etc/apparmor/profiles/extra`, YaST informs you that there is an inactive profile which you can either use as a base for your own efforts or which you can just accept as is.

Alternatively, you can choose not to use the local version at all and start creating the profile from scratch. In any case, proceed with Step 7 (page 275).

- 6** If the profile already exists in the external profile repository and this is the first time you tried to create a profile that already exists in the repository, configure your access to the server and determine how to use it:
 - 6a** Determine whether you want to enable access to the external repository or postpone this decision. In case you have selected *Enable Repository*, determine the access mode (download/upload) in a next step. In case you want to postpone the decision, select *Ask Me Later* and proceed directly to Step 7 (page 275).
 - 6b** Provide username and password for your account on the profile repository server and register at the server.
 - 6c** Select the profile to use and proceed to Step 7 (page 275).

7 Run the application to profile.

- 8** Perform as many of the application functions as possible, so that learning mode can log the files and directories to which the program requires access to function properly. Be sure to include restarting and stopping the program in the exercised functions. AppArmor needs to handle these events, as well as any other program function.
- 9** Click *Scan system log for AppArmor events* to parse the learning mode log files. This generates a series of questions that you must answer to guide the wizard in generating the security profile.

If requests to add hats appear, proceed to Chapter 25, *Profiling Your Web Applications Using ChangeHat* (page 319).

The questions fall into two categories:

- A resource is requested by a profiled program that is not in the profile (see Figure 23.2, “Learning Mode Exception: Controlling Access to Specific Resources” (page 276)). Allow or deny access to a specific resource.
- A program is executed by the profiled program and the security domain transition has not been defined (see Figure 23.3, “Learning Mode Exception: Defining Execute Permissions for an Entry” (page 277)). Define execute permissions for an entry.

Each of these cases results in a series of questions that you must answer to add the resource to the profile or to add the program to the profile. For an example of each case, see Figure 23.2, “Learning Mode Exception: Controlling Access to Specific Resources” (page 276) and Figure 23.3, “Learning Mode Exception: Defining Execute Permissions for an Entry” (page 277). Subsequent steps describe your options in answering these questions.

NOTE: Varying Processing Options

Depending on the type of entry processed, the available options vary.

Figure 23.2 *Learning Mode Exception: Controlling Access to Specific Resources*

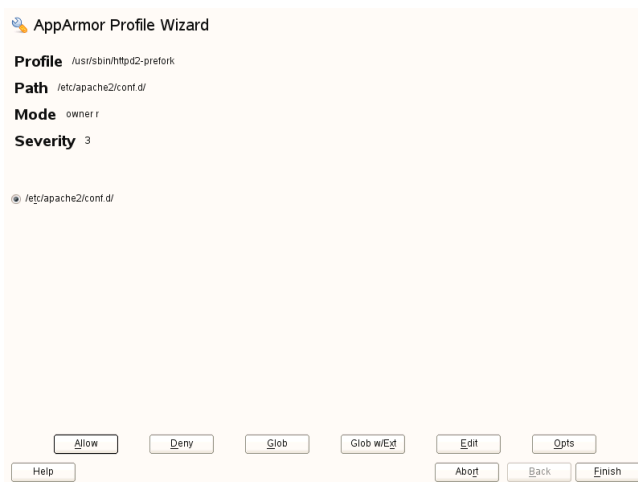
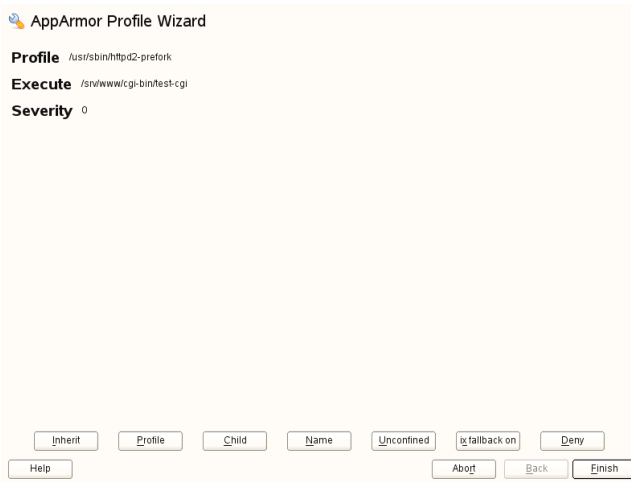

Figure 23.3 *Learning Mode Exception: Defining Execute Permissions for an Entry*



10 The *Add Profile Wizard* begins suggesting directory path entries that have been accessed by the application profiled (as seen in Figure 23.2, “Learning Mode Exception: Controlling Access to Specific Resources” (page 276)) or requires you to define execute permissions for entries (as seen in Figure 23.3, “Learning Mode Exception: Defining Execute Permissions for an Entry” (page 277)).

- For Figure 23.2: Learning Mode Exception: Controlling Access to Specific Resources: Select the option that satisfies the request for access, which could be a suggested include, a particular globbed version of the path, or the actual pathname. Depending on the situation, these options are available:

```
#include
```

The section of a Novell AppArmor profile that refers to an include file. Include files give access permissions for programs. By using an include, you can give the program access to directory paths or files that are also required by other programs. Using includes can reduce the size of a profile. It is good practice to select includes when suggested.

Globbered Version

Accessed by clicking *Glob*. For information about globbing syntax, refer to Section 21.6, “Paths and Globbing” (page 252).

Actual Pathname

Literal path that the program needs to access to run properly.

After selecting a directory path, process it as an entry to the Novell AppArmor profile by clicking *Allow* or *Deny*. If you are not satisfied with the directory path entry as it is displayed, you can also *Glob* or *Edit* it.

The following options are available to process the learning mode entries and build the profile:

Allow

Grant the program access to the specified directory path entries. The *Add Profile Wizard* suggests file permission access. For more information about this, refer to Section 21.7, “File Permission Access Modes” (page 255).

Deny

Click *Deny* to prevent the program from accessing the specified paths.

Glob

Clicking this modifies the directory path (using wild cards) to include all files in the suggested directory. Double-clicking it grants access to all files and subdirectories beneath the one shown. For more information about globbing syntax, refer to Section 21.6, “Paths and Globbing” (page 252).

Glob w/Ext

Modify the original directory path while retaining the filename extension. A single click causes `/etc/apache2/file.ext` to become `/etc/apache2/*.ext`, adding the wild card (asterisk) in place of the filename. This allows the program to access all files in the suggested directories that end with the `.ext` extension. When you double-click it, access is granted to all files with the particular extension and subdirectories beneath the one shown.

Edit

Edit the highlighted line. The new edited line appears at the bottom of the list.

Abort

Abort aa-logprof, losing all rule changes entered so far and leaving all profiles unmodified.

Finish

Close aa-logprof, saving all rule changes entered so far and modifying all profiles.

Click *Allow* or *Deny* for each learning mode entry. These help build the Novell AppArmor profile.

NOTE

The number of learning mode entries corresponds to the complexity of the application.

- For Figure 23.3: Learning Mode Exception: Defining Execute Permissions for an Entry: From the following options, select the one that satisfies the request for access. For detailed information about the options available, refer to Section 21.7, “File Permission Access Modes” (page 255).

Inherit

Stay in the same security profile (parent's profile).

Profile

Require a separate profile to exist for the executed program. When selecting this option, also select whether AppArmor should sanitize the environment when switching profiles by removing certain environment variables that can modify the execution behavior of the child process. Unless these variables are absolutely required to properly execute the child process, always choose the more secure, sanitized option.

Unconfined

Execute the program without a security profile. When prompted, have AppArmor sanitize the environment to avoid adding security risks by inheriting certain environmental variables from the parent process.

WARNING: Risks of Running Unconfined

Unless absolutely necessary, do not run unconfined. Choosing the *Unconfined* option executes the new program without any protection from AppArmor.

Deny

Click *Deny* to prevent the program from accessing the specified paths.

Abort

Abort aa-logprof, losing all rule changes entered so far, and leaving all profiles unmodified.

Finish

Close aa-logprof, saving all rule changes entered so far, and modifying all profiles.

- 11** Repeat the previous steps if you need to execute more functionality of the application.

When you are done, click *Finish*. Choose to apply your changes to the local profile set. If you have previously chosen to upload your profile to the external profile repository, provide a brief change log entry describing your work and upload the profile. If you had postponed the decision on whether to upload the profile or not, YaST asks you again and you can create an account the upload the profile now or not upload it at all.

As soon as you exit the *Profile Creation Wizard*, the profile is saved both locally and on the repository server, if you have chosen to upload it. The profile is then loaded into the AppArmor module.

23.2 Manually Adding a Profile

Novell AppArmor enables you to create a Novell AppArmor profile by manually adding entries into the profile. Select the application for which to create a profile then add entries.

- 1 Start YaST and select *Novell AppArmor > Manually Add Profile*.
- 2 Browse your system to find the application for which to create a profile.
- 3 When you find the application, select it and click *Open*. A basic, empty profile appears in the *AppArmor Profile Dialog* window.
- 4 In *AppArmor Profile Dialog*, add, edit, or delete AppArmor profile entries by clicking the corresponding buttons and referring to Section 23.3.1, “Adding an Entry” (page 283), Section 23.3.2, “Editing an Entry” (page 286), or Section 23.3.3, “Deleting an Entry” (page 287).
- 5 When finished, click *Done*.

23.3 Editing Profiles

AppArmor enables you to edit Novell AppArmor profiles manually by adding, editing, or deleting entries. To edit a profile, proceed as follows:

- 1 Start YaST and select *Novell AppArmor > Edit Profile*.

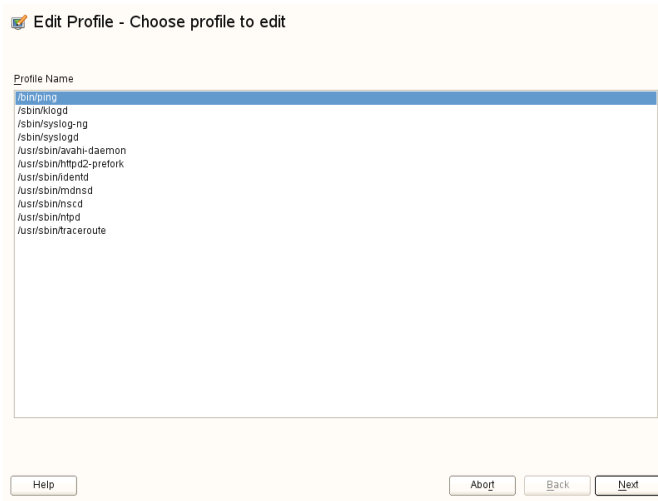

- 2 From the list of profiled applications, select the profile to edit.
- 3 Click *Next*. The *AppArmor Profile Dialog* window displays the profile.

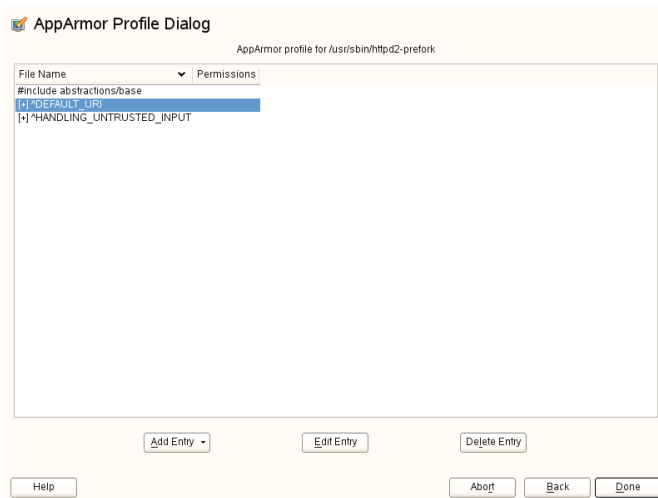

- 4 In the *AppArmor Profile Dialog* window, add, edit, or delete Novell AppArmor profile entries by clicking the corresponding buttons and referring to Sec-

tion 23.3.1, “Adding an Entry” (page 283), Section 23.3.2, “Editing an Entry” (page 286), or Section 23.3.3, “Deleting an Entry” (page 287).

- 5 When you are finished, click *Done*.
- 6 In the pop-up that appears, click *Yes* to confirm your changes to the profile and reload the AppArmor profile set.

TIP: Syntax Checking in AppArmor

AppArmor contains a syntax check that notifies you of any syntax errors in profiles you are trying to process with the YaST AppArmor tools. If an error occurs, edit the profile manually as `root` and reload the profile set with `rcapparmor reload`.

23.3.1 Adding an Entry

The *Add Entry* option can be found in Section 23.2, “Manually Adding a Profile” (page 281) or Section 23.3, “Editing Profiles” (page 281). When you select *Add Entry*, a list shows the types of entries you can add to the Novell AppArmor profile.

From the list, select one of the following:

File

In the pop-up window, specify the absolute path of a file, including the type of access permitted. When finished, click *OK*.

You can use globbing if necessary. For globbing information, refer to Section 21.6, “Paths and Globbing” (page 252). For file access permission information, refer to Section 21.7, “File Permission Access Modes” (page 255).

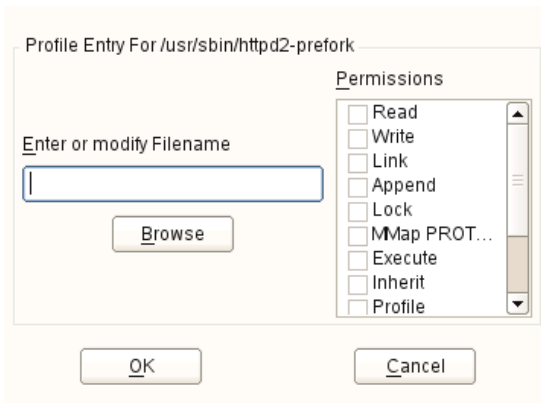

Directory

In the pop-up window, specify the absolute path of a directory, including the type of access permitted. You can use globbing if necessary. When finished, click *OK*.

For globbing information, refer to Section 21.6, “Paths and Globbing” (page 252).

For file access permission information, refer to Section 21.7, “File Permission Access Modes” (page 255).

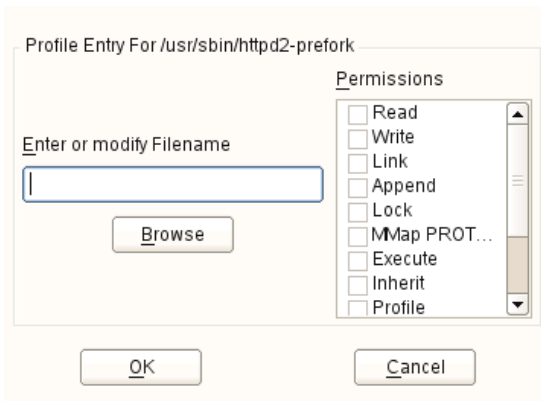

Network Rule

In the pop-up window, select the appropriate network family and the socket type.

For more information, refer to Section 21.5, “Network Access Control” (page 251).

Network Family Socket Type

All All

Cancel Save

Capability

In the pop-up window, select the appropriate capabilities. These are statements that enable each of the 32 POSIX.1e capabilities. Refer to Section 21.4, “Capability Entries (POSIX.1e)” (page 251) for more information about capabilities. When finished making your selections, click *OK*.

Capabilities enabled for the profile /usr/sbin/httpd2-prefork

Capabilities

- CAP_CHOWN
- CAP_DAC_OVERRIDE
- CAP_DAC_READ_SEA...
- CAP_FOWNER
- CAP_FSETID
- CAP_IPC_LOCK
- CAP_IPC_OWNER
- CAP_KILL
- CAP_LEASE
- CAP_LINUX_IMMUTABLE
- CAP_MKNOD
- CAP_NET_ADMIN
- CAP_NET_BIND_SERV...
- CAP_NET_BROADCAST
- CAP_NET_RAW
- CAP_SETGID
- CAP_SETPCAP
- CAP_SETUID
- CAP_SYS_ADMIN
- CAP_SYS_BOOT
- CAP_SYS_CHROOT

Capability Selection

Select desired capabilities for this profile. Select a Capability name to see information about the capability.

OK Cancel

Include

In the pop-up window, browse to the files to use as includes. Includes are directives that pull in components of other Novell AppArmor profiles to simplify profiles. For more information, refer to Section 21.3, “#include Statements” (page 250).

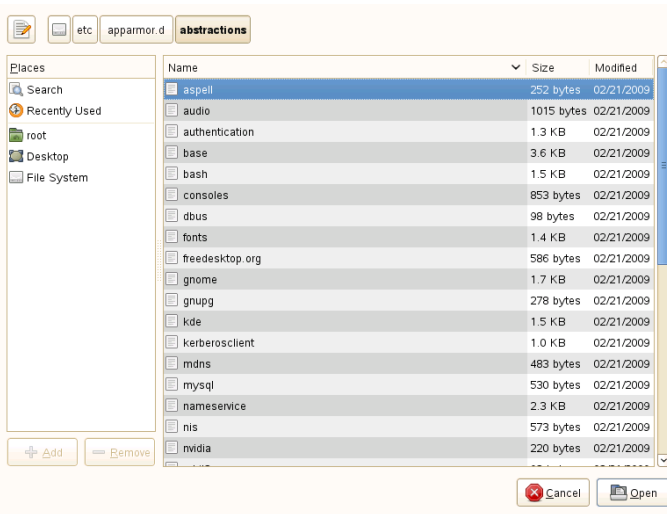

Hat

In the pop-up window, specify the name of the subprofile (*hat*) to add to your current profile and click *Create Hat*. For more information, refer to Chapter 25, *Profiling Your Web Applications Using ChangeHat* (page 319).



23.3.2 Editing an Entry

When you select *Edit Entry*, the file browser pop-up window opens. From here, edit the selected entry.

In the pop-up window, specify the absolute path of a file, including the type of access permitted. You can use globbing if necessary. When finished, click *OK*.

For globbing information, refer to Section 21.6, “Paths and Globbing” (page 252). For file access permission information, refer to Section 21.7, “File Permission Access Modes” (page 255).

23.3.3 Deleting an Entry

To delete an entry in a given profile, select *Delete Entry*. AppArmor removes the selected profile entry.

23.4 Deleting a Profile

AppArmor enables you to delete an AppArmor profile manually. Simply select the application for which to delete a profile then delete it as follows:

- 1 Start YaST and select *Novell AppArmor > Delete Profile*.
- 2 Select the profile to delete.
- 3 Click *Next*.
- 4 In the pop-up that opens, click *Yes* to delete the profile and reload the AppArmor profile set.

23.5 Updating Profiles from Log Entries

The Novell AppArmor profile wizard uses *aa-logprof*, the tool that scans log files and enables you to update profiles. *aa-logprof* tracks messages from the Novell AppArmor module that represent exceptions for all profiles running on your system. These exceptions represent the behavior of the profiled application that is outside of the profile definition for the program. You can add the new behavior to the relevant profile by selecting the suggested profile entry.

TIP: Support for the External Profile Repository

Similar to the *Add Profile Wizard*, the *Update Profile Wizard* also supports profile exchange with the external repository server. For background information on the use of the external AppArmor profile repository, refer to Section 22.2, “Using the External Repository” (page 268). For details on how to configure access and access mode to the server, check the procedure described under Section 23.1, “Adding a Profile Using the Wizard” (page 273).

- 1 Start YaST and select *Novell AppArmor > Update Profile Wizard*.

Running *Update Profile Wizard* (aa-logprof) parses the learning mode log files. This generates a series of questions that you must answer to guide aa-logprof to generate the security profile. The exact procedure is the same as with creating a new profile. Refer to Step 9 (page 275) in Section 23.1, “Adding a Profile Using the Wizard” (page 273) for details.

- 2 When you are done, click *Finish*. In the following pop-up, click *Yes* to exit the *Add Profile Wizard*. The profile is saved and loaded into the Novell AppArmor module.

23.6 Managing Novell AppArmor and Security Event Status

You can change the status of AppArmor by enabling or disabling it. Enabling AppArmor protects your system from potential program exploitation. Disabling AppArmor, even if your profiles have been set up, removes protection from your system. You can determine how and when you are notified when system security events occur.

NOTE

For event notification to work, you must set up a mail server on your system that can send outgoing mail using the single mail transfer protocol (SMTP), such as postfix or exim.

To configure event notification or change the status of AppArmor, start YaST and select *Novell AppArmor > Novell AppArmor Control Panel*.

AppArmor Configuration

Enable AppArmor

Configure AppArmor

Security Event Notification

Notification is disabled

[Configure](#)

Configure Profile Modes

Set profile modes

[Configure](#)

[Help](#)

[About](#)

[Back](#)

[Done](#)

From the *AppArmor Configuration* screen, determine whether Novell AppArmor and security event notification are running by looking for a status message that reads *enabled* or configure the mode of individual profiles.

To change the status of Novell AppArmor, continue as described in Section 23.6.1, “Changing Novell AppArmor Status” (page 289). To change the mode of individual profiles, continue as described in Section 23.6.2, “Changing the Mode of Individual Profiles” (page 290). To configure security event notification, continue as described in Section 27.2, “Configuring Security Event Notification” (page 334).

23.6.1 Changing Novell AppArmor Status

When you change the status of AppArmor, set it to enabled or disabled. When AppArmor is enabled, it is installed, running, and enforcing the AppArmor security policies.

- 1 Start YaST and select *Novell AppArmor > AppArmor Control Panel*.
- 2 Enable AppArmor by checking *Enable AppArmor* or disable AppArmor by deselecting it.
- 3 Click *Done* in the *AppArmor Configuration* window.

- 4 Click *File > Quit* in the YaST Control Center.

23.6.2 Changing the Mode of Individual Profiles

AppArmor can apply profiles in two different modes. In *complain* or *learning* mode, violations of AppArmor profile rules, such as the profiled program accessing files not permitted by the profile, are detected. The violations are permitted, but also logged. This mode is convenient for developing profiles and is used by the AppArmor tools for generating profiles. Loading a profile in *enforce* mode enforces the policy defined in the profile and reports policy violation attempts to syslogd.

The *Profile Modes* dialog allows you to view and edit the mode of currently loaded AppArmor profiles. This feature is useful for determining the status of your system during profile development. During the course of systemic profiling (see Section 24.6.2, “Systemic Profiling” (page 296)), you can use this tool to adjust and monitor the scope of the profiles for which you are learning behavior.

To edit an application's profile mode, proceed as follows:

- 1 Start YaST and select *Novell AppArmor > AppArmor Control Panel*.
- 2 In the *Configure Profile Modes* section, select *Configure*.
- 3 Select the profile for which to change the mode.
- 4 Select *Toggle Mode* to set this profile to *complain* mode or to *enforce* mode.
- 5 Apply your settings and leave YaST with *Done*.

To change the mode of all profiles, use *Set All to Enforce* or *Set All to Complain*.

TIP: Listing the Profiles Available

By default, only active profiles are listed (any profile that has a matching application installed on your system). To set up a profile before installing the respective application, click *Show All Profiles* and select the profile to configure from the list that appears.

Building Profiles from the Command Line

24

Novell® AppArmor provides the user the ability to use a command line interface rather than a graphical interface to manage and configure the system security. Track the status of Novell AppArmor and create, delete, or modify AppArmor profiles using the AppArmor command line tools.

TIP: Background Information

Before starting to manage your profiles using the AppArmor command line tools, check out the general introduction to AppArmor given in Chapter 20, *Immunizing Programs* (page 233) and Chapter 21, *Profile Components and Syntax* (page 243).

24.1 Checking the AppArmor Module Status

An AppArmor module can be in any one of three states:

Unloaded

The AppArmor module is not loaded into the kernel.

Running

The AppArmor module is loaded into the kernel and is enforcing AppArmor program policies.

Stopped

The AppArmor module is loaded into the kernel, but no policies are enforced.

Detect the state of the AppArmor module by inspecting `/sys/kernel/security/apparmor/profiles`. If `cat /sys/kernel/security/apparmor/profiles` reports a list of profiles, AppArmor is running. If it is empty and returns nothing, AppArmor is stopped. If the file does not exist, AppArmor is unloaded.

Manage AppArmor through the script `rcapparmor`, which can perform the following operations:

`rcapparmor start`

Behavior depends on the AppArmor module state. If it is unloaded, `start` loads the module and starts it, putting it in the running state. If it is stopped, `start` causes the module to rescan the AppArmor profiles usually found in `/etc/apparmor.d` and puts the module in the running state. If the module is already running, `start` reports a warning and takes no action.

`rcapparmor stop`

Stops the AppArmor module if it is running by removing all profiles from kernel memory, effectively disabling all access controls, and putting the module into the stopped state. If the AppArmor module is unloaded or already stopped, `stop` tries to unload the profiles again, but nothing happens.

`rcapparmor restart`

Causes the AppArmor module to rescan the profiles in `/etc/apparmor.d` without unconfining running processes. Freshly created profiles are enforced and recently deleted ones are removed from the `/etc/apparmor.d` directory.

`rcapparmor kill`

Unconditionally removes the AppArmor module from the kernel. However, unloading modules from the Linux kernel is unsafe. This command is provided only for debugging and emergencies (when the module might need to be removed).

WARNING

AppArmor is a powerful access control system and it is possible to lock yourself out of your own machine to the point where you must boot the machine from a rescue medium (such as the first medium of SUSE Linux Enterprise Server) to regain control.

To prevent such a problem, always ensure that you have a running, unconfined, `root` login on the machine being configured when you restart the AppArmor module. If you damage your system to the point where logins are no longer possible (for example, by breaking the profile associated with the SSH daemon), you can repair the damage using your running `root` prompt then restarting the AppArmor module.

24.2 Building AppArmor Profiles

The AppArmor module profile definitions are stored in the `/etc/apparmor.d` directory as plain text files. For a detailed description of the syntax of these files, refer to Chapter 21, *Profile Components and Syntax* (page 243).

All files in the `/etc/apparmor.d` directory are interpreted as profiles and are loaded as such. Renaming files in that directory is not an effective way of preventing profiles from being loaded. You must remove profiles from this directory to prevent them from being read and evaluated effectively.

You can use a text editor, such as `vim`, to access and make changes to these profiles. The following options contain detailed steps for building profiles:

Adding or Creating AppArmor Profiles

Refer to Section 24.3, “Adding or Creating an AppArmor Profile” (page 294)

Editing AppArmor Profiles

Refer to Section 24.4, “Editing an AppArmor Profile” (page 294)

Deleting AppArmor Profiles

Refer to Section 24.5, “Deleting an AppArmor Profile” (page 294)

24.3 Adding or Creating an AppArmor Profile

To add or create an AppArmor profile for an application, you can use a systemic or stand-alone profiling method, depending on your needs. Learn more about these two approaches in Section 24.6, “Two Methods of Profiling” (page 295).

24.4 Editing an AppArmor Profile

The following steps describe the procedure for editing an AppArmor profile:

- 1 If you are not currently logged in as `root`, enter `su` in a terminal window.
- 2 Enter the `root` password when prompted.
- 3 Go to the profile directory with `cd /etc/apparmor.d/`.
- 4 Enter `ls` to view all profiles currently installed.
- 5 Open the profile to edit in a text editor, such as `vim`.
- 6 Make the necessary changes then save the profile.
- 7 Restart AppArmor by entering `rcapparmor restart` in a terminal window.

24.5 Deleting an AppArmor Profile

The following steps describe the procedure for deleting an AppArmor profile.

- 1 If you are not currently logged in as `root`, enter `su` in a terminal window.
- 2 Enter the `root` password when prompted.
- 3 Go to the AppArmor directory with `cd /etc/apparmor.d/`.

- 4 Enter `ls` to view all the AppArmor profiles that are currently installed.
- 5 Delete the profile with `rm profilename`.
- 6 Restart AppArmor by entering `rcapparmor restart` in a terminal window.

24.6 Two Methods of Profiling

Given the syntax for AppArmor profiles in Chapter 21, *Profile Components and Syntax* (page 243), you could create profiles without using the tools. However, the effort involved would be substantial. To avoid such a situation, use the AppArmor tools to automate the creation and refinement of profiles.

There are two ways to approach AppArmor profile creation. Tools are available for both methods.

Stand-Alone Profiling

A method suitable for profiling small applications that have a finite run time, such as user client applications like mail clients. For more information, refer to Section 24.6.1, “Stand-Alone Profiling” (page 296).

Systemic Profiling

A method suitable for profiling large numbers of programs all at once and for profiling applications that may run for days, weeks, or continuously across reboots, such as network server applications like Web servers and mail servers. For more information, refer to Section 24.6.2, “Systemic Profiling” (page 296).

Automated profile development becomes more manageable with the AppArmor tools:

- 1 Decide which profiling method suits your needs.
- 2 Perform a static analysis. Run either `aa-genprof` or `aa-autodep`, depending on the profiling method chosen.
- 3 Enable dynamic learning. Activate learning mode for all profiled programs.

24.6.1 Stand-Alone Profiling

Stand-alone profile generation and improvement is managed by a program called `aa-genprof`. This method is easy because `aa-genprof` takes care of everything, but is limited because it requires `aa-genprof` to run for the entire duration of the test run of your program (you cannot reboot the machine while you are still developing your profile).

To use `aa-genprof` for the stand-alone method of profiling, refer to Section “`aa-genprof`—Generating Profiles” (page 301).

24.6.2 Systemic Profiling

This method is called *systemic profiling* because it updates all of the profiles on the system at once, rather than focusing on the one or few targeted by `aa-genprof` or stand-alone profiling. With systemic profiling, profile construction and improvement are somewhat less automated, but more flexible. This method is suitable for profiling long-running applications whose behavior continues after rebooting, or a large number of programs all at once.

Build an AppArmor profile for a group of applications as follows:

- 1 Create profiles for the individual programs that make up your application.

Although this approach is systemic, AppArmor only monitors those programs with profiles and their children. To get AppArmor to consider a program, you must at least have `aa-autodep` create an approximate profile for it. To create this approximate profile, refer to Section “`aa-autodep`—Creating Approximate Profiles” (page 298).

- 2 Put relevant profiles into learning or complain mode.

Activate learning or complain mode for all profiled programs by entering `aa-complain /etc/apparmor.d/*` in a terminal window while logged in as `root`. This functionality is also available through the YaST Profile Mode module, described in Section 23.6.2, “Changing the Mode of Individual Profiles” (page 290).

When in learning mode, access requests are not blocked, even if the profile dictates that they should be. This enables you to run through several tests (as shown

in Step 3 (page 297)) and learn the access needs of the program, so it runs properly. With this information, you can decide how secure to make the profile.

Refer to Section “aa-complain—Entering Complain or Learning Mode” (page 299) for more detailed instructions for using learning or complain mode.

3 Exercise your application.

Run your application and exercise its functionality. How much to exercise the program is up to you, but you need the program to access each file representing its access needs. Because the execution is not being supervised by aa-genprof, this step can go on for days or weeks and can span complete system reboots.

4 Analyze the log.

In systemic profiling, run aa-logprof directly instead of letting aa-genprof run it (as in stand-alone profiling). The general form of aa-logprof is:

```
aa-logprof [ -d /path/to/profiles ] [ -f /path/to/logfile ]
```

Refer to Section “aa-logprof—Scanning the System Log” (page 310) for more information about using aa-logprof.

5 Repeat Step 3 (page 297) and Step 4 (page 297).

This generates optimum profiles. An iterative approach captures smaller data sets that can be trained and reloaded into the policy engine. Subsequent iterations generate fewer messages and run faster.

6 Edit the profiles.

You might want to review the profiles that have been generated. You can open and edit the profiles in `/etc/apparmor.d/` using vim.

7 Return to enforce mode.

This is when the system goes back to enforcing the rules of the profiles, not just logging information. This can be done manually by removing the `flags=(complain)` text from the profiles or automatically by using the `aa-enforce` command, which works identically to the `aa-complain` command, except it sets the profiles to enforce mode. This functionality is also

available through the YaST Profile Mode module, described in Section 23.6.2, “Changing the Mode of Individual Profiles” (page 290).

To ensure that all profiles are taken out of complain mode and put into enforce mode, enter `aa-enforce /etc/apparmor.d/*`.

8 Rescan all profiles.

To have AppArmor rescan all of the profiles and change the enforcement mode in the kernel, enter `rcapparmor restart`.

24.6.3 Summary of Profiling Tools

All of the AppArmor profiling utilities are provided by the `apparmor-utils` RPM package and are stored in `/usr/sbin`. Each tool has a different purpose.

aa-autodep—Creating Approximate Profiles

This creates an approximate profile for the program or application selected. You can generate approximate profiles for binary executables and interpreted script programs. The resulting profile is called “approximate” because it does not necessarily contain all of the profile entries that the program needs to be properly confined by AppArmor. The minimum `aa-autodep` approximate profile has, at minimum, a base include directive, which contains basic profile entries needed by most programs. For certain types of programs, `aa-autodep` generates a more expanded profile. The profile is generated by recursively calling `ldd(1)` on the executables listed on the command line.

To generate an approximate profile, use the `aa-autodep` program. The program argument can be either the simple name of the program, which `aa-autodep` finds by searching your shell's path variable, or it can be a fully qualified path. The program itself can be of any type (ELF binary, shell script, Perl script, etc.). `aa-autodep` generates an approximate profile to improve through the dynamic profiling that follows.

The resulting approximate profile is written to the `/etc/apparmor.d` directory using the AppArmor profile naming convention of naming the profile after the absolute path of the program, replacing the forward slash (`/`) characters in the path with period (`.`) characters. The general form of `aa-autodep` is to enter the following in a terminal window when logged in as `root`:

```
aa-autodep [ -d /path/to/profiles ] [program1 program2...]
```

If you do not enter the program name or names, you are prompted for them.

/path/to/profiles overrides the default location of */etc/apparmor.d*, should you keep profiles in a location other than the default.

To begin profiling, you must create profiles for each main executable service that is part of your application (anything that might start without being a child of another program that already has a profile). Finding all such programs depends on the application in question. Here are several strategies for finding such programs:

Directories

If all the programs to profile are in one directory and there are no other programs in that directory, the simple command `aa-autodep /path/to/your/programs/*` creates basic profiles for all programs in that directory.

ps command

You can run your application and use the standard Linux `ps` command to find all processes running. Then manually hunt down the location of these programs and run the `aa-autodep` for each one. If the programs are in your path, `aa-autodep` finds them for you. If they are not in your path, the standard Linux command `find` might be helpful in finding your programs. Execute `find / -name 'my_application' -print` to determine an application's path (*my_application* being an example application). You may use wild cards if appropriate.

aa-complain—Entering Complain or Learning Mode

The complain or learning mode tool (`aa-complain`) detects violations of AppArmor profile rules, such as the profiled program accessing files not permitted by the profile. The violations are permitted, but also logged. To improve the profile, turn complain mode on, run the program through a suite of tests to generate log events that characterize the program's access needs, then postprocess the log with the AppArmor tools to transform log events into improved profiles.

Manually activating complain mode (using the command line) adds a flag to the top of the profile so that `/bin/foo` becomes `/bin/foo flags=(complain)`. To use complain mode, open a terminal window and enter one of the following lines as `root`:

- If the example program (*program1*) is in your path, use:

```
aa-complain [program1 program2 ...]
```

- If the program is not in your path, specify the entire path as follows:

```
aa-complain /sbin/program1
```

- If the profiles are not in `/etc/apparmor.d`, use the following to override the default location:

```
aa-complain /path/to/profiles/ program1
```

- Specify the profile for *program1* as follows:

```
aa-complain /etc/apparmor.d/sbin.program1
```

Each of the above commands activates the complain mode for the profiles or programs listed. If the program name does not include its entire path, `aa-complain` searches `$PATH` for the program. For instance, `aa-complain /usr/sbin/*` finds profiles associated with all of the programs in `/usr/sbin` and puts them into complain mode.

`aa-complain /etc/apparmor.d/*` puts all of the profiles in `/etc/apparmor.d` into complain mode.

TIP: Toggling Profile Mode with YaST

YaST offers a graphical front-end for toggling complain and enforce mode. See Section 23.6.2, “Changing the Mode of Individual Profiles” (page 290) for information.

aa-enforce—Entering Enforce Mode

The enforce mode detects violations of AppArmor profile rules, such as the profiled program accessing files not permitted by the profile. The violations are logged and not permitted. The default is for enforce mode to be enabled. To log the violations only, but still permit them, use complain mode. Enforce toggles with complain mode.

Manually activating enforce mode (using the command line) adds a flag to the top of the profile so that `/bin/foo` becomes `/bin/foo flags=(enforce)`. To use enforce mode, open a terminal window and enter one of the following lines as `root`.

- If the example program (*program1*) is in your path, use:

```
aa-enforce [program1 program2 ...]
```

- If the program is not in your path, specify the entire path, as follows:

```
aa-enforce /sbin/program1
```

- If the profiles are not in `/etc/apparmor.d`, use the following to override the default location:

```
aa-enforce /path/to/profiles/program1
```

- Specify the profile for *program1* as follows:

```
aa-enforce /etc/apparmor.d/sbin.program1
```

Each of the above commands activates the enforce mode for the profiles and programs listed.

If you do not enter the program or profile names, you are prompted to enter one.

`/path/to/profiles` overrides the default location of `/etc/apparmor.d`.

The argument can be either a list of programs or a list of profiles. If the program name does not include its entire path, `aa-enforce` searches `$PATH` for the program.

TIP: Toggling Profile Mode with YaST

YaST offers a graphical front-end for toggling complain and enforce mode. See Section 23.6.2, “Changing the Mode of Individual Profiles” (page 290) for information.

aa-genprof—Generating Profiles

`aa-genprof` is AppArmor's profile generating utility. It runs `aa-autodep` on the specified program, creating an approximate profile (if a profile does not already exist for it), sets

it to complain mode, reloads it into AppArmor, marks the log, and prompts the user to execute the program and exercise its functionality. Its syntax is as follows:

```
aa-genprof [ -d /path/to/profiles ] program
```

To create a profile for the the Apache Web server program `httpd2-prefork`, do the following as `root`:

- 1 Enter `rcapache2 stop`.
- 2 Next, enter `aa-genprof httpd2-prefork`.

Now `aa-genprof` does the following:

1. Resolves the full path of `httpd2-prefork` using your shell's path variables. You can also specify a full path. On SUSE Linux Enterprise Server, the default full path is `/usr/sbin/httpd2-prefork`.
2. Checks to see if there is an existing profile for `httpd2-prefork`. If there is one, it updates it. If not, it creates one using the `aa-autodep` as described in Section 24.6.3, “Summary of Profiling Tools” (page 298).
3. Puts the profile for this program into learning or complain mode so that profile violations are logged, but are permitted to proceed. A log event looks like this (see `/var/log/audit/audit.log`):

```
type=APPARMOR_ALLOWED msg=audit(1189682639.184:20816):
operation="file_mmap" requested_mask="::r" denied_mask="::r" fsuid=30
name="/srv/www/htdocs/index.html" pid=27471
profile="null-complain-profile"
```

If you are not running the audit daemon, the AppArmor events are logged to `/var/log/messages`:

```
Sep 13 13:20:30 K23 kernel: audit(1189682430.672:20810):
operation="file_mmap" requested_mask="::r" denied_mask="::r" fsuid=30
name="/srv/www/htdocs/phpsysinfo/templates/bulix/form.tpl" pid=30405
profile="/usr/sbin/httpd2-prefork//phpsysinfo/"
```

They also can be viewed using the `dmesg` command:

```
audit(1189682430.672:20810): operation="file_mmap"
requested_mask="::r" denied_mask="::r" fsuid=30
name="/srv/www/htdocs/phpsysinfo/templates/bulix/form.tpl" pid=30405
profile="/usr/sbin/httpd2-prefork//phpsysinfo/"
```

4. Marks the log with a beginning marker of log events to consider. For example:

```
Sep 13 17:48:52 figwit root: GenProf:  
e2ff78636296f16d0b5301209a04430d
```

- 3 When prompted by the tool, run the application to profile in another terminal window and perform as many of the application functions as possible. Thus, the learning mode can log the files and directories to which the program requires access in order to function properly. For example, in a new terminal window, enter `rcapache2 start`.
- 4 Select from the following options that are available in the `aa-logprof` terminal window after you have executed the program function:
 - `S` runs `aa-logprof` on the system log from where it was marked when `aa-genprof` was started and reloads the profile. If system events exist in the log, AppArmor parses the learning mode log files. This generates a series of questions that you must answer to guide `aa-genprof` in generating the security profile.
 - `F` exits the tool and returns to the main menu.

NOTE

If requests to add hats appear, proceed to Chapter 25, *Profiling Your Web Applications Using ChangeHat* (page 319).

- 5 Answer two types of questions:
 - A resource is requested by a profiled program that is not in the profile (see Example 24.1, “Learning Mode Exception: Controlling Access to Specific Resources” (page 304)).
 - A program is executed by the profiled program and the security domain transition has not been defined (see Example 24.2, “Learning Mode Exception: Defining Execute Permissions for an Entry” (page 306)).

Each of these categories results in a series of questions that you must answer to add the resource or program to the profile. Example 24.1, “Learning Mode Ex-

ception: Controlling Access to Specific Resources” (page 304) and Example 24.2, “Learning Mode Exception: Defining Execute Permissions for an Entry” (page 306) provide examples of each one. Subsequent steps describe your options in answering these questions.

- Dealing with execute accesses is complex. You must decide how to proceed with this entry regarding which execute permission type to grant to this entry:

Example 24.1 *Learning Mode Exception: Controlling Access to Specific Resources*

```
Reading log entries from /var/log/audit/audit.log.  
Updating AppArmor profiles in /etc/apparmor.d.
```

```
Profile: /usr/sbin/xinetd  
Program: xinetd  
Execute: /usr/lib/cups/daemon/cups-lpd  
Severity: unknown
```

```
[(I)nherit] / (P)rofile / (U)nconfined / (D)eny / Abo(r)t / (F)inish
```

Inherit (ix)

The child inherits the parent's profile, running with the same access controls as the parent. This mode is useful when a confined program needs to call another confined program without gaining the permissions of the target's profile or losing the permissions of the current profile. This mode is often used when the child program is a *helper application*, such as the `/usr/bin/mail` client using `less` as a pager or the Mozilla* Web browser using Adobe Acrobat* to display PDF files.

Profile (px)

The child runs using its own profile, which must be loaded into the kernel. If the profile is not present, attempts to execute the child fail with permission denied. This is most useful if the parent program is invoking a global service, such as DNS lookups or sending mail with your system's MTA.

Choose the *profile with clean exec (Px)* option to scrub the environment of environment variables that could modify execution behavior when passed to the child process.

Unconfined (ux)

The child runs completely unconfined without any AppArmor profile applied to the executed resource.

Choose the *unconfined with clean exec* (Ux) option to scrub the environment of environment variables that could modify execution behavior when passed to the child process. This option introduces a security vulnerability that could be used to exploit AppArmor. Only use it as a last resort.

mmap (m)

This permission denotes that the program running under the profile can access the resource using the mmap system call with the flag `PROT_EXEC`. This means that the data mapped in it can be executed. You are prompted to include this permission if it is requested during a profiling run.

Deny

Prevents the program from accessing the specified directory path entries. AppArmor then continues to the next event.

Abort

Aborts aa-logprof, losing all rule changes entered so far and leaving all profiles unmodified.

Finish

Closes aa-logprof, saving all rule changes entered so far and modifying all profiles.

- Example 24.2, “Learning Mode Exception: Defining Execute Permissions for an Entry” (page 306) shows AppArmor suggesting directory path entries that have been accessed by the application being profiled. It might also require you to define execute permissions for entries.

Example 24.2 Learning Mode Exception: Defining Execute Permissions for an Entry

Adding /bin/ps ix to profile.

```
Profile: /usr/sbin/xinetd
Path: /etc/hosts.allow
New Mode: r
```

```
[1 - /etc/hosts.allow]
```

```
[(A)llow] / [(D)eny] / [(N)ew] / [(G)lob] / Glob w/[(E)xt] / Abo(r)t /
[(F)inish]
```

AppArmor provides one or more paths or includes. By entering the option number, select the desired options then proceed to the next step.

NOTE

All of these options are not always presented in the AppArmor menu.

#include

This is the section of an AppArmor profile that refers to an include file, which procures access permissions for programs. By using an include, you can give the program access to directory paths or files that are also required by other programs. Using includes can reduce the size of a profile. It is good practice to select includes when suggested.

Globbered Version

This is accessed by selecting *Glob* as described in the next step. For information about globbing syntax, refer to Section 21.6, “Paths and Globbing” (page 252).

Actual Path

This is the literal path to which the program needs access so that it can run properly.

After you select the path or include, process it as an entry into the AppArmor profile by selecting *Allow* or *Deny*. If you are not satisfied with the directory path entry as it is displayed, you can also *Glob* it.

The following options are available to process the learning mode entries and build the profile:

Select Enter

Allows access to the selected directory path.

Allow

Allows access to the specified directory path entries. AppArmor suggests file permission access. For more information, refer to Section 21.7, “File Permission Access Modes” (page 255).

Deny

Prevents the program from accessing the specified directory path entries. AppArmor then continues to the next event.

New

Prompts you to enter your own rule for this event, allowing you to specify a regular expression. If the expression does not actually satisfy the event that prompted the question in the first place, AppArmor asks for confirmation and lets you reenter the expression.

Glob

Select a specific path or create a general rule using wild cards that match a broader set of paths. To select any of the offered paths, enter the number that is printed in front of the path then decide how to proceed with the selected item.

For more information about globbing syntax, refer to Section 21.6, “Paths and Globbing” (page 252).

Glob w/Ext

This modifies the original directory path while retaining the filename extension. For example, `/etc/apache2/file.ext` becomes `/etc/apache2/*.ext`, adding the wild card (asterisk) in place of the filename. This allows the program to access all files in the suggested directory that end with the `.ext` extension.

Abort

Aborts `aa-logprof`, losing all rule changes entered so far and leaving all profiles unmodified.

Finish

Closes `aa-logprof`, saving all rule changes entered so far and modifying all profiles.

- 6 To view and edit your profile using vim, enter `vim /etc/apparmor.d/profilename` in a terminal window.
- 7 Restart AppArmor and reload the profile set including the newly created one using the `rcapparmor restart` command.

Like the graphical front-end for building AppArmor profiles, the YaST Add Profile Wizard, `aa-genprof` also supports the use of the local profile repository under `/etc/apparmor/profiles/extras` and the remote AppArmor profile repository.

To use a profile from the local repository, proceed as follows:

- 1 Start `aa-genprof` as described above.

If `aa-genprof` finds an inactive local profile, the following lines appear on your terminal window:

```
Profile: /usr/bin/opera  
  
[1 - Inactive local profile for /usr/bin/opera]  
  
[(V)iew Profile] / (U)se Profile / (C)reate New Profile / Abo(r)t /  
(F)inish
```

- 2 If you want to just use this profile, hit `U` (*Use Profile*) and follow the profile generation procedure outlined above.

If you want to examine the profile before activating it, hit `V` (*View Profile*).

If you want to ignore the existing profile, hit `C` (*Create New Profile*) and follow the profile generation procedure outlined above to create the profile from scratch.

- 3 Leave `aa-genprof` by hitting `F` (*Finish*) when you are done and save your changes.

To use the remote AppArmor profile repository with `aa-genprof`, proceed as follows:

- 1 Start `aa-genprof` as described above.

If `aa-genprof` detects a suitable profile on the repository server, the following lines appear on your terminal window:

```
Repository: http://apparmor.opensuse.org/backend/api  
  
Would you like to enable access to the profile repository?
```

```
(E)nable Repository / (D)isable Repository / Ask Me (L)ater
```

2 Hit **E** (*Enable Repository*) to enable the repository.

3 Determine whether you want to aa-genprof to upload any profiles to the repository server:

```
Would you like to upload newly created and changed profiles to  
the profile repository?
```

```
(Y)es / (N)o / Ask Me (L)ater
```

Hit **Y** (*Yes*), if you want to enable profile upload or select **N** (*No*), if you want aa-genprof to just pull profiles from the repository, but not to upload any.

4 Create a new user on the profile repository server to be able to upload profiles. Provide username and password.

5 Determine whether you want to use the profile downloaded from the server or whether you would just like to review it:

```
Profile: /usr/bin/opera
```

```
[1 - novell]
```

```
[(V)iew Profile] / (U)se Profile / (C)reate New Profile / Abo(r)t /  
(F)inish
```

If you want to just use this profile, hit **U** (*Use Profile*) and follow the profile generation procedure outlined above.

If you want to examine the profile before activating it, hit **V** (*View Profile*).

If you want to ignore the existing profile, hit **C** (*Create New Profile*) and follow the profile generation procedure outlined above to create the profile from scratch.

6 Leave aa-genprof by hitting **F** (*Finish*) when you are done and save the profile.

If you opted for uploading your profile, provide a short change log and push it to the repository.

aa-logprof—Scanning the System Log

aa-logprof is an interactive tool used to review the learning or complain-mode output found in the log entries in `/var/log/audit/audit.log` or `/var/log/messages` (if `auditd` is not running) and generate new entries in AppArmor security profiles.

When you run `aa-logprof`, it begins to scan the log files produced in learning or complain mode and, if there are new security events that are not covered by the existing profile set, it gives suggestions for modifying the profile. The learning or complain mode traces program behavior and enters it in the log. `aa-logprof` uses this information to observe program behavior.

If a confined program forks and executes another program, `aa-logprof` sees this and asks the user which execution mode should be used when launching the child process. The execution modes *ix*, *px*, *Px*, *ux*, and *Ux* are options for starting the child process. If a separate profile exists for the child process, the default selection is *px*. If one does not exist, the profile defaults to *ix*. Child processes with separate profiles have `aa-autodep` run on them and are loaded into AppArmor, if it is running.

When `aa-logprof` exits, profiles are updated with the changes. If the AppArmor module is running, the updated profiles are reloaded and, if any processes that generated security events are still running in the null-complain-profile, those processes are set to run under their proper profiles.

TIP: Support for the External Profile Repository

Similar to the `aa-genprof`, `aa-logprof` also supports profile exchange with the external repository server. For background information on the use of the external AppArmor profile repository, refer to Section 22.2, “Using the External Repository” (page 268). For details on how to configure access and access mode to the server, check the procedure described under Section “aa-genprof—Generating Profiles” (page 301).

To run `aa-logprof`, enter `aa-logprof` into a terminal window while logged in as `root`. The following options can be used for `aa-logprof`:

```
aa-logprof -d /path/to/profile/directory/
```

Specifies the full path to the location of the profiles if the profiles are not located in the standard directory, `/etc/apparmor.d/`.

```
aa-logprof -f /path/to/logfile/
```

Specifies the full path to the location of the log file if the log file is not located in the default directory, `/var/log/audit/audit.log` or `/var/log/messages` (if `auditd` is not running).

```
aa-logprof -m "string marker in logfile"
```

Marks the starting point for `aa-logprof` to look in the system log. `aa-logprof` ignores all events in the system log before the specified mark. If the mark contains spaces, it must be surrounded by quotes to work correctly. For example:

```
aa-logprof -m"17:04:21"
```

or

```
logprof -m e2ff78636296f16d0b5301209a04430d
```

`aa-logprof` scans the log, asking you how to handle each logged event. Each question presents a numbered list of AppArmor rules that can be added by pressing the number of the item on the list.

By default, `aa-logprof` looks for profiles in `/etc/apparmor.d/` and scans the log in `/var/log/messages`. In many cases, running `aa-logprof` as `root` is enough to create the profile.

However, there might be times when you need to search archived log files, such as if the program exercise period exceeds the log rotation window (when the log file is archived and a new log file is started). If this is the case, you can enter `zcat -f `ls -ltr /var/log/messages*` | aa-logprof -f -`.

aa-logprof Example 1

The following is an example of how `aa-logprof` addresses `httpd2-prefork` accessing the file `/etc/group`. `[]` indicates the default option.

In this example, the access to `/etc/group` is part of `httpd2-prefork` accessing name services. The appropriate response is `1`, which includes a predefined set of AppArmor rules. Selecting `1` to `#include` the name service package resolves all of the future

questions pertaining to DNS lookups and also makes the profile less brittle in that any changes to DNS configuration and the associated name service profile package can be made just once, rather than needing to revise many profiles.

```
Profile: /usr/sbin/httpd2-prefork
Path: /etc/group
New Mode: r

[1 - #include <abstractions/nameservice>]
 2 - /etc/group
[(A)llow] / (D)eny / (N)ew / (G)lob / Glob w/(E)xt / Abo(r)t / (F)inish
```

Select one of the following responses:

Select Enter

Triggers the default action, which is, in this example, allowing access to the specified directory path entry.

Allow

Allows access to the specified directory path entries. AppArmor suggests file permission access. For more information about this, refer to Section 21.7, “File Permission Access Modes” (page 255).

Deny

Prevents the program from accessing the specified directory path entries. AppArmor then continues to the next event.

New

Prompts you to enter your own rule for this event, allowing you to specify whatever form of regular expression you want. If the expression entered does not actually satisfy the event that prompted the question in the first place, AppArmor asks for confirmation and lets you reenter the expression.

Glob

Select either a specific path or create a general rule using wild cards that matches on a broader set of paths. To select any of the offered paths, enter the number that is printed in front of the paths then decide how to proceed with the selected item.

For more information about globbing syntax, refer to Section 21.6, “Paths and Globbing” (page 252).

Glob w/Ext

This modifies the original directory path while retaining the filename extension. For example, `/etc/apache2/file.ext` becomes `/etc/apache2/*.ext`, adding the wild card (asterisk) in place of the filename. This allows the program to access all files in the suggested directory that end with the `.ext` extension.

Abort

Aborts `aa-logprof`, losing all rule changes entered so far and leaving all profiles unmodified.

Finish

Closes `aa-logprof`, saving all rule changes entered so far and modifying all profiles.

aa-logprof Example 2

For example, when profiling `vsftpd`, see this question:

```
Profile: /usr/sbin/vsftpd
Path:    /y2k.jpg
New Mode: r
```

```
[1 - /y2k.jpg]
```

```
(A)llow / [(D)eny] / (N)ew / (G)lob / Glob w/(E)xt / Abo(r)t / (F)inish
```

Several items of interest appear in this question. First, note that `vsftpd` is asking for a path entry at the top of the tree, even though `vsftpd` on SUSE Linux Enterprise Server serves FTP files from `/srv/ftp` by default. This is because `httpd2-prefork` uses `chroot` and, for the portion of the code inside the `chroot` jail, `AppArmor` sees file accesses in terms of the `chroot` environment rather than the global absolute path.

The second item of interest is that you might want to grant FTP read access to all JPEG files in the directory, so you could use *Glob w/Ext* and use the suggested path of `/*.jpg`. Doing so collapses all previous rules granting access to individual `.jpg` files and forestalls any future questions pertaining to access to `.jpg` files.

Finally, you might want to grant more general access to FTP files. If you select *Glob* in the last entry, `aa-logprof` replaces the suggested path of `/y2k.jpg` with `/*`. Alternatively, you might want to grant even more access to the entire directory tree, in which case you could use the *New path* option and enter `/**/*.jpg` (which would grant access

to all `.jpg` files in the entire directory tree) or `/**` (which would grant access to all files in the directory tree).

These items deal with read accesses. Write accesses are similar, except that it is good policy to be more conservative in your use of regular expressions for write accesses. Dealing with execute accesses is more complex. Find an example in Example 24.1, “Learning Mode Exception: Controlling Access to Specific Resources” (page 304).

In the following example, the `/usr/bin/mail` mail client is being profiled and `aa-logprof` has discovered that `/usr/bin/mail` executes `/usr/bin/less` as a helper application to “page” long mail messages. Consequently, it presents this prompt:

```
/usr/bin/nail -> /usr/bin/less
(I)nherit / (P)rofile / (U)nconfined / (D)eny
```

TIP

The actual executable file for `/usr/bin/mail` turns out to be `/usr/bin/nail`, which is not a typographical error.

The program `/usr/bin/less` appears to be a simple one for scrolling through text that is more than one screen long and that is in fact what `/usr/bin/mail` is using it for. However, `less` is actually a large and powerful program that makes use of many other helper applications, such as `tar` and `rpm`.

TIP

Run `less` on a tar file or an RPM file and it shows you the inventory of these containers.

You do not want to run `rpm` automatically when reading mail messages (that leads directly to a Microsoft* Outlook-style virus attack, because `rpm` has the power to install and modify system programs), so, in this case, the best choice is to use *Inherit*. This results in the `less` program executed from this context running under the profile for `/usr/bin/mail`. This has two consequences:

- You need to add all of the basic file accesses for `/usr/bin/less` to the profile for `/usr/bin/mail`.

- You can avoid adding the helper applications, such as tar and rpm, to the `/usr/bin/mail` profile so that when `/usr/bin/mail` runs `/usr/bin/less` in this context, the less program is far less dangerous than it would be without AppArmor protection.

In other circumstances, you might instead want to use the *Profile* option. This has two effects on aa-logprof:

- The rule written into the profile uses `px`, which forces the transition to the child's own profile.
- aa-logprof constructs a profile for the child and starts building it, in the same way that it built the parent profile, by assigning events for the child process to the child's profile and asking the aa-logprof user questions.

If a confined program forks and executes another program, aa-logprof sees this and asks the user which execution mode should be used when launching the child process. The execution modes of `inherit`, `profile`, `unconfined` or an option to deny the execution are presented.

If a separate profile exists for the child process, the default selection is `profile`. If a profile does not exist, the default is `inherit`. The `inherit` option, or `ix`, is described in Section 21.7, “File Permission Access Modes” (page 255).

The `profile` option indicates that the child program should run in its own profile. A secondary question asks whether to sanitize the environment that the child program inherits from the parent. If you choose to sanitize the environment, this places the execution modifier `Px` in your AppArmor profile. If you select not to sanitize, `px` is placed in the profile and no environment sanitizing occurs. The default for the execution mode is `px` if you select `profile` execution mode.

The `unconfined` execution mode is not recommended and should only be used in cases where there is no other option to generate a profile for a program reliably. Selecting `unconfined` opens a warning dialog asking for confirmation of the choice. If you are sure and choose *Yes*, a second dialog asks whether to sanitize the environment. Choosing *Yes* uses the execution mode `Ux` in your profile. Choosing *No* uses the execution mode `ux` for your profile. The default value selected is `Ux` for `unconfined` execution mode.

IMPORTANT: Running Unconfined

Choosing `ux` is very dangerous and provides no enforcement of policy (from a security perspective) of the resulting execution behavior of the child program.

aa-unconfined—Identifying Unprotected Processes

The `aa-unconfined` command examines open network ports on your system, compares that to the set of profiles loaded on your system, and reports network services that do not have AppArmor profiles. It requires `root` privileges and that it not be confined by an AppArmor profile.

`aa-unconfined` must be run as `root` to retrieve the process executable link from the `/proc` file system. This program is susceptible to the following race conditions:

- An unlinked executable is mishandled
- A process that dies between `netstat(8)` and further checks is mishandled

NOTE

This program lists processes using TCP and UDP only. In short, this program is unsuitable for forensics use and is provided only as an aid to profiling all network-accessible processes in the lab.

24.7 Important Filenames and Directories

The following list contains the most important files and directories used by the AppArmor framework. If you intend to manage and troubleshoot your profiles manually, make sure that you know about these files and directories:

`/sys/kernel/security/apparmor/profiles`

Virtualized file representing the currently loaded set of profiles.

`/etc/apparmor/`

Location of AppArmor configuration files.

`/etc/apparmor/profiles/extras/`

A local repository of profiles shipped with AppArmor, but not enabled by default.

`/etc/apparmor.d/`

Location of profiles, named with the convention of replacing the `/` in paths with `.` (not for the root `/`) so profiles are easier to manage. For example, the profile for the program `/usr/sbin/ntpd` is named `usr.sbin.ntpd`.

`/etc/apparmor.d/abstractions/`

Location of abstractions.

`/etc/apparmor.d/program-chunks/`

Location of program chunks.

`/proc/*/attr/current`

Check this file to review the confinement status of a process and the profile that is used to confine the process. The `ps auxZ` command retrieves this information automatically.

Profiling Your Web Applications Using ChangeHat

25

A Novell® AppArmor profile represents the security policy for an individual program instance or process. It applies to an executable program, but if a portion of the program needs different access permissions than other portions, the program can “change hats” to use a different security context, distinctive from the access of the main program. This is known as a *hat* or *subprofile*.

ChangeHat enables programs to change to or from a *hat* within a Novell AppArmor profile. It enables you to define security at a finer level than the process. This feature requires that each application be made “ChangeHat aware”, meaning that it is modified to make a request to the Novell AppArmor module to switch security domains at arbitrary times during the application execution. Two examples for ChangeHat-aware applications are the Apache Web server and Tomcat.

A profile can have an arbitrary number of subprofiles, but there are only two levels: a subprofile cannot have further sub-subprofiles. A subprofile is written as a separate profile and named as the containing profile followed by the subprofile name, separated by a `^`. Subprofiles must be stored in the same file as the parent profile.

Note that the security of hats is considerably weaker than that of full profiles. That is to say, if attackers can find just the right kind of bug in a program, they may be able to escape from a hat into the containing profile. This is because the security of hats is determined by a secret key handled by the containing process, and the code running in the hat must not have access to the key. Thus `change_hat` is most useful in conjunction with application servers, where a language interpreter (such as PERL, PHP, or Java) is isolating pieces of code such that they do not have direct access to the memory of the containing process.

The rest of this chapter describes using `change_hat` in conjunction with Apache, to contain web server components run using `mod_perl` and `mod_php`. Similar approaches can be used with any application server by providing an application module similar to the `mod_apparmor` described next in Section 25.2.2, “Location and Directory Directives” (page 327).

NOTE: For More Information

For more information, see the `change_hat` man page.

25.1 Apache ChangeHat

Novell AppArmor provides a `mod_apparmor` module (package `apache2-mod-apparmor`) for the Apache program (only included in SUSE Linux Enterprise Server). This module makes the Apache Web server ChangeHat aware. Install it along with Apache.

When Apache is ChangeHat aware, it checks for the following customized Novell AppArmor security profiles in the order given for every URI request that it receives.

- URI-specific hat. For example, `^phpsysinfo/templates/classic/images/bar_left.gif`
- `DEFAULT_URI`
- `HANDLING_UNTRUSTED_INPUT`

NOTE: Apache Configuration

If you install `apache2-mod-apparmor`, make sure the module gets loaded in Apache by executing the following command:

```
a2enmod apparmor
```

25.1.1 Managing ChangeHat-Aware Applications

As with most of the Novell AppArmor tools, you can use two methods for managing ChangeHat, YaST or the command line interface. Managing ChangeHat-aware applications from the command line is much more flexible, but the process is also more complicated. Both methods allow you to manage the hats for your application and populate them with profile entries.

The following steps are a demonstration that adds hats to an Apache profile using YaST. In the *Add Profile Wizard*, the Novell AppArmor profiling utilities prompt you to create new hats for distinct URI requests. Choosing to create a new hat allows you to create individual profiles for each URI. You can create very tight rules for each request.

If the URI that is processed does not represent significant processing or otherwise does not represent a significant security risk, safely select *Use Default Hat* to process this URI in the default hat, which is the default security profile.

This example creates a new hat for the URI `phpsysinfo` and its subsequent accesses. Using the profiling utilities, delegate what to add to this new hat. The resulting hat becomes a tight-security container that encompasses all the processing on the server that occurs when the `phpsysinfo` URI is passed to the Apache Web server.

The URI runs the application `phpsysinfo` (refer to <http://phpsysinfo.sourceforge.net> for more information). The `phpsysinfo` package is assumed to be installed in `/srv/www/htdocs/phpsysinfo` in a clean (new) installation of SUSE Linux Enterprise Server and AppArmor.

- 1 Once `phpsysinfo` is installed, you are ready to add hats to the Apache profile. From the Novell AppArmor GUI, select *Add Profile Wizard*.
- 2 In *Application to Profile*, enter `httpd2-prefork`.
- 3 Click *Create Profile*.

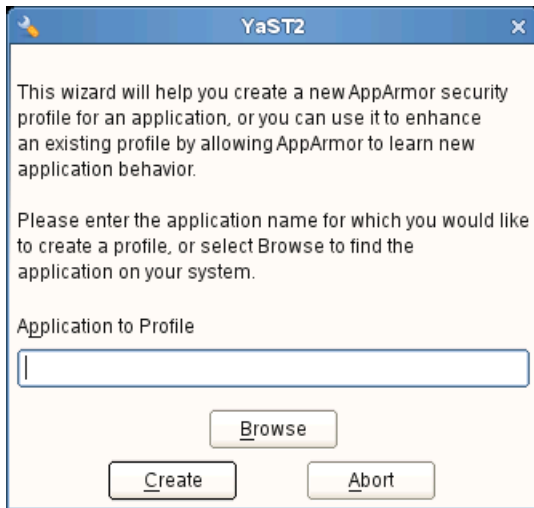

- 4 Restart Apache by entering `rcapache2 restart` in a terminal window.

Restart any program you are profiling at this point.

- 5 Open `http://localhost/phpsysinfo/` in a Web browser window. The browser window should display network usage and system information.

NOTE: Data Caching

To ensure that this request is processed by the server and you do not review cached data in your browser, refresh the page. To do this, click the browser *Refresh* button to make sure that Apache processes the request for the `phpsysinfo` URI.

- 6 Click *Scan System Log for Entries to Add to Profiles*. Novell AppArmor launches the `aa-logprof` tool, which scans the information learned in the previous step. It begins to prompt you with profile questions.
- 7 `aa-logprof` first prompts with *Add Requested Hat* or *Use Default Hat* because it noticed that the `phpsysinfo` URI was accessed. Select *Add Requested Hat*.
- 8 Click *Allow*.

Choosing *Add Requested Hat* in the previous step creates a new hat in the profile and specifies that the results of subsequent questions about the script's actions are added to the newly created hat rather than the default hat for this application.

In the next screen, Novell AppArmor displays an external program that the script executed. You can specify that the program should run confined by the `phpsysinfo` hat (choose *Inherit*), confined by a separate profile (choose *Profile*), or that it should run unconfined or without any security profile (choose *Unconfined*). For the case of the *Profile* option, a new profile is created for the program if one does not already exist.

NOTE: Security Considerations

Selecting *Unconfined* can create a significant security hole and should be done with caution.

8a Select *Inherit* for the `/bin/bash` path. This adds `/bin/bash` (accessed by Apache) to the `phpsysinfo` hat profile with the necessary permissions.

8b Click *Allow*.

9 The remaining questions prompt you to generate new hats and add entries to your profile and its hats. The process of adding entries to profiles is covered in detail in the Section 23.1, “Adding a Profile Using the Wizard” (page 273).

When all profiling questions are answered, click *Finish* to save your changes and exit the wizard.

The following is an example `phpsysinfo` hat.

Example 25.1 *Example phpsysinfo Hat*

```
/usr/sbin/httpd2-prefork {
...
^phpsysinfo {
  #include <abstractions/bash>
  #include <abstractions/nameservice>

  /bin/basename          ixr,
  /bin/bash              ixr,
  /bin/df                ixr,
  /bin/grep              ixr,
  /bin/mount             Ux,
  /bin/sed               ixr,
  /dev/bus/usb/          r,
  /dev/bus/usb/**       r,
  /dev/null              w,
  /dev/tty               rw,
  /dev/urandom           r,
  /etc/SuSE-release      r,
  /etc/ld.so.cache       r,
  /etc/lsb-release       r,
  /etc/lsb-release.d/   r,
  /lib/ld-2.6.1.so       ixr,
  /proc/**               r,
  /sbin/lspci            ixr,
  /srv/www/htdocs/phpsysinfo/** r,
  /sys/bus/pci/**        r,
  /sys/bus/scsi/devices/ r,
  /sys/devices/**       r,
  /usr/bin/cut           ixr,
  /usr/bin/getopt        ixr,
  /usr/bin/head          ixr,
  /usr/bin/lsb_release   ixr,
  /usr/bin/lsscsi        ixr,
  /usr/bin/tr            ixr,
  /usr/bin/who           ixr,
  /usr/lib/lib*so*       mr,
  /usr/lib/locale/**     r,
  /usr/sbin/lusb         ixr,
  /usr/share/locale/**   r,
  /usr/share/pci.ids     r,
  /usr/share/usb.ids     r,
  /var/log/apache2/access_log w,
  /var/run/utmp          kr,
}
}
```

NOTE: Hat and Parent Profile Relationship

The profile `^phpsysinfo` is only valid in the context of a process running under the parent profile `httpd2-prefork`.

25.1.2 Adding Hats and Entries to Hats

When you use the *Edit Profile* dialog (for instructions, refer to Section 23.3, “Editing Profiles” (page 281)) or when you add a new profile using *Manually Add Profile* (for instructions, refer to Section 23.2, “Manually Adding a Profile” (page 281)), you are given the option of adding hats (subprofiles) to your Novell AppArmor profiles. Add a *ChangeHat* subprofile from the *AppArmor Profile Dialog* window as in the following.

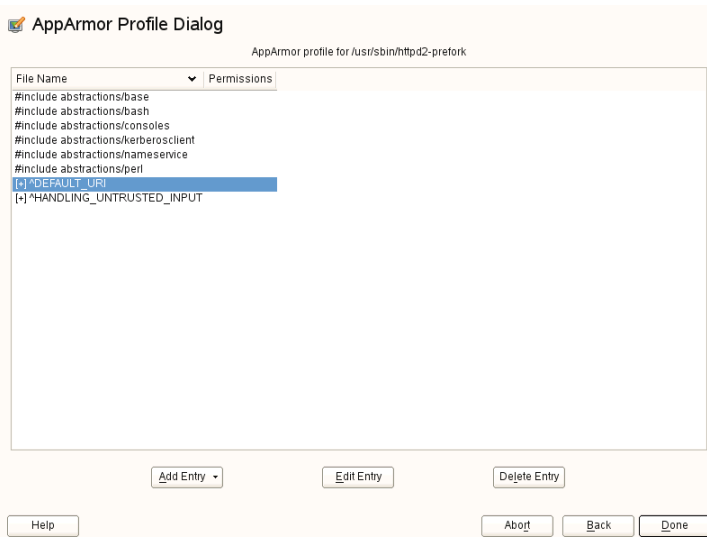

- 1 From the *AppArmor Profile Dialog* window, click *Add Entry* then select *Hat*. The *Enter Hat Name* dialog box opens:

Please enter the name of the Hat that you would like to add to the profile /usr/sbin/httpd2-prefork.

Hat name to add

- 2 Enter the name of the hat to add to the Novell AppArmor profile. The name is the URI that, when accessed, receives the permissions set in the hat.
- 3 Click *Create Hat*. You are returned to the *AppArmor Profile Dialog* screen.
- 4 After adding the new hat, click *Done*.

NOTE: For More Information

For an example of an Novell AppArmor profile, refer to Example 25.1, “Example phpsysinfo Hat” (page 324).

25.2 Configuring Apache for mod_apparmor

Apache is configured by placing directives in plain text configuration files. The main configuration file is usually `httpd.conf`. When you compile Apache, you can indicate the location of this file. Directives can be placed in any of these configuration files to alter the way Apache behaves. When you make changes to the main configuration files, you need to start or restart Apache, so the changes are recognized.

25.2.1 Virtual Host Directives

Virtual host directives control whether requests that contain trailing pathname information following an actual filename (or that refer to a nonexistent file in an existing directory) are accepted or rejected. For Apache documentation on virtual host directives,

refer to <http://httpd.apache.org/docs-2.2/mod/core.html#virtualhost>.

The ChangeHat-specific configuration keyword is `AADefaultHatName`. It is used similarly to `AAHatName`, for example, `AADefaultHatName My_Funky_Default_Hat`.

The configuration option is actually based on a server directive, which enables you to use the keyword outside of other options, setting it for the default server. Virtual hosts are considered internally within Apache to be separate “servers,” so you can set a default hat name for the default server as well as one for each virtual host, if desired.

When a request comes in, the following steps reflect the sequence in which `mod_apparmor` attempts to apply hats.

1. A location or directory hat as specified by the `AAHatName` keyword
2. A hat named by the entire URI path
3. A default server hat as specified by the `AADefaultHatName` keyword
4. `DEFAULT_URI` (if none of those exist, it goes back to the “parent” Apache hat)

25.2.2 Location and Directory Directives

Location and directory directives specify hat names in the program configuration file so the program calls the hat regarding its security. For Apache, you can find documentation about the location and directory directives at <http://httpd.apache.org/docs-2.2/sections.html>.

The location directive example below specifies that, for a given location, `mod_apparmor` should use a specific hat:

```
<Location /foo/> AAHatName MY_HAT_NAME </Location>
```

This tries to use `MY_HAT_NAME` for any URI beginning with `/foo/` (`/foo/`, `/foo/bar`, `/foo/cgi/path/blah_blah/blah`, etc.).

The directory directive works similarly to the location directive, except it refers to a path in the file system as in the following example:

```
<Directory "/srv/www/www.immunix.com/docs">
  # Note lack of trailing slash
  AAHatName immunix.com
</Directory>
```

Example: The program `phpsysinfo` is used to illustrate a location directive in the following example. The tarball can be downloaded from <http://phpsysinfo.sourceforge.net>.

- 1 After downloading the tarball, install it into `/srv/www/htdocs/phpsysinfo`.
- 2 Create `/etc/apache2/conf.d/phpsysinfo.conf` and add the following text to it:

```
<Location "/phpsysinfo">
  AAHatName phpsysinfo
</Location>
```

The following hat should then work for `phpsysinfo`:

```
/usr/sbin/httpd2-prefork {
  ...
  ^phpsysinfo {
    #include <abstractions/bash>
    #include <abstractions/namespace>

    /bin/basename          ixr,
    /bin/bash              ixr,
    /bin/df                ixr,
    /bin/grep              ixr,
    /bin/mount             Ux,
    /bin/sed               ixr,
    /dev/bus/usb/          r,
    /dev/bus/usb/**        r,
    /dev/null              w,
    /dev/tty               rw,
    /dev/urandom           r,
    /etc/SuSE-release      r,
    /etc/ld.so.cache       r,
    /etc/lsb-release       r,
    /etc/lsb-release.d/    r,
    /lib/ld-2.6.1.so       ixr,
    /proc/**               r,
    /sbin/lspci            ixr,
```

```

/srv/www/htdocs/phpsysinfo/**      r,
/sys/bus/pci/**                      r,
/sys/bus/scsi/devices/              r,
/sys/devices/**                      r,
/usr/bin/cut                          ixr,
/usr/bin/getopt                       ixr,
/usr/bin/head                         ixr,
/usr/bin/lsb_release                  ixr,
/usr/bin/lsscsi                       ixr,
/usr/bin/tr                           ixr,
/usr/bin/who                          ixr,
/usr/lib/lib*so*                     mr,
/usr/lib/locale/**                   r,
/usr/sbin/lsub                         ixr,
/usr/share/locale/**                 r,
/usr/share/pci.ids                    r,
/usr/share/usb.ids                    r,
/var/log/apache2/access_log           w,
/var/run/utmp                         kr,
}

```

- 3** Reload Novell AppArmor profiles by entering `rcapparmor restart` at a terminal window as `root`.
- 4** Restart Apache by entering `rcapache2 restart` at a terminal window as `root`.
- 5** Enter `http://hostname/phpsysinfo/` into a browser to receive the system information that `phpsysinfo` delivers.
- 6** Locate configuration errors by going to `/var/log/audit/audit.log` or running `dmesg` and looking for any rejections in the output.

Confining Users with `pam_apparmor`

26

An AppArmor profile applies to an executable program; if a portion of the program needs different access permissions than other portions need, the program can change hats via `change_hat` to a different role, also known as a subprofile. The `pam_apparmor` PAM module allows applications to confine authenticated users into subprofiles based on group names, user names, or a default profile. To accomplish this, `pam_apparmor` needs to be registered as a PAM session module.

The package `pam_apparmor` may not be installed by default, you may need to install it using `YaST` or `zypper`. Details about how to set up and configure `pam_apparmor` can be found in `/usr/share/doc/packages/pam_apparmor/README` after the package has been installed. For details on PAM, refer to Chapter 2, *Authentication with PAM* (page 17).

`pam_apparmor` allows you to set up role-based access control (RBAC). In conjunction with the set capabilities rules (see Section 21.11, “Setting Capabilities per Profile” (page 265) for more information), it allows you to map restricted admin profiles to users. A detailed HOWTO on setting up RBAC with AppArmor is available at http://developer.novell.com/wiki/index.php/Apparmor_RBAC_in_version_2.3.

Managing Profiled Applications

27

After creating profiles and immunizing your applications, SUSE® Linux Enterprise Server becomes more efficient and better protected as long as you perform Novell® AppArmor profile maintenance (which involves analyzing log files, refining your profiles, backing up your set of profiles and keeping it up-to-date). You can deal with these issues before they become a problem by setting up event notification by e-mail, running periodic reports, updating profiles from system log entries by running the `aa-logprof` tool through YaST, and dealing with maintenance issues.

27.1 Monitoring Your Secured Applications

Applications that are confined by Novell AppArmor security profiles generate messages when applications execute in unexpected ways or outside of their specified profile. These messages can be monitored by event notification, periodic report generation, or integration into a third-party reporting mechanism.

For reporting and alerting, AppArmor uses a userspace daemon (`/usr/sbin/aa-eventd`). This daemon monitors log traffic, sends out notifications, and runs scheduled reports. It does not require any end user configuration and it is started automatically as part of the security event notification through the YaST AppArmor Control Panel or by the configuration of scheduled reports in the YaST AppArmor Reports module.

Apart from transparently enabling and disabling `aa-eventd` with the YaST modules, you can manually toggle its status with the `rcaaeventd` init script. The AppArmor event daemon is not required for proper functioning of the profiling process (such as enforcement or learning). It is just required for reporting.

Find more details on security event notification in Section 27.2, “Configuring Security Event Notification” (page 334) and on scheduled reports in Section 27.3, “Configuring Reports” (page 337).

If you prefer a simple way of being notified of any AppArmor reject events that does not require you to check your e-mails or any log files, use the AppArmor Desktop Monitor applet that integrates into the GNOME desktop. Refer to Section 27.4, “Configuring and Using the AppArmor Desktop Monitor Applet” (page 357) for details.

27.2 Configuring Security Event Notification

Security event notification is a Novell AppArmor feature that informs you when systemic Novell AppArmor activity occurs. Activate it by selecting a notification frequency (receiving daily notification, for example). Enter an e-mail address so you can be notified by e-mail when Novell AppArmor security events occur. Select one of the following notification types:

Terse

Terse notification summarizes the total number of system events without providing details. For example:

```
jupiter.example.com has had 41 security events since Mon Sep 10 14:53:16
2007.
```

Summary Notification

Summary notification displays the logged Novell AppArmor security events and lists the number of individual occurrences, including the date of the last occurrence. For example:

```
AppArmor: PERMITTING access to capability 'setgid' (httpd2-prefork(6347)
profile /usr/sbin/httpd2-prefork active /usr/sbin/httpd2-prefork) 2 times,
the latest at Sat Oct 9 16:05:54 2004.
```

Verbose Notification

Verbose notification displays unmodified, logged Novell AppArmor security events. It tells you every time an event occurs and writes a new line in the verbose log. These security events include the date and time the event occurred, when the application profile permits and rejects access, and the type of file permission access that is permitted or rejected. Verbose notification also reports several messages that the aa-logprof tool (see Section “aa-logprof—Scanning the System Log” (page 310)) uses to interpret profiles. For example:

```
type=APPARMOR_DENIED msg=audit(1189428793.218:2880):
  operation="file_permission" requested_mask="::w" denied_mask="::w"
  fsuid=1000 name="/var/log/apache2/error_log" pid=22969
  profile="/usr/sbin/httpd2-prefork"
```

NOTE

You must set up a mail server that can send outgoing mail using the SMTP protocol (for example, postfix or exim) for event notification to work.

- 1 In the *Enable Security Event Notification* section of the *AppArmor Configuration* window, click *Configure*.

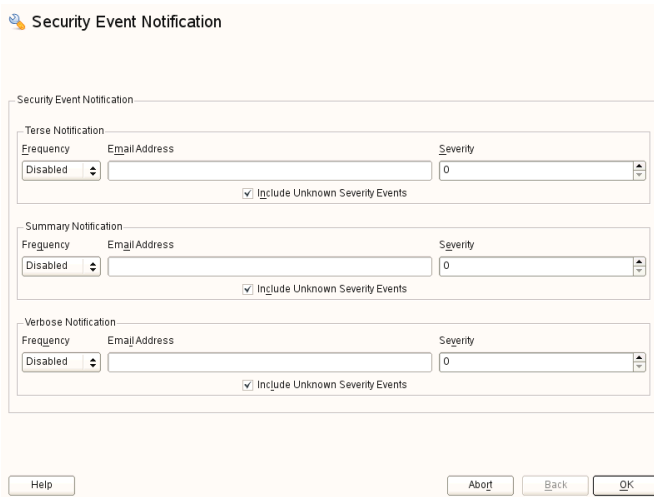

The screenshot shows the "Security Event Notification" configuration window. It has a title bar with a gear icon and the text "Security Event Notification". The window contains three sections: "Terse Notification", "Summary Notification", and "Verbose Notification". Each section has a "Frequency" dropdown menu (all set to "Disabled"), an "Email Address" text field (all empty), and a "Severity" dropdown menu (all set to "0"). Below each section is a checkbox labeled "Include Unknown Severity Events", which is checked in all three sections. At the bottom of the window are four buttons: "Help", "About", "Back", and "OK".

- 2 In the *Security Event Notification* window, enable *Terse*, *Summary*, or *Verbose* event notification.

2a In each applicable notification type section, enter the e-mail addresses of those who should receive notification in the field provided. If notification is enabled, you must enter an e-mail address. Separate multiple e-mail addresses with commas.

2b For each notification type enabled, select the frequency of notification.

Select a notification frequency from the following options:

- Disabled
- 1 minute
- 5 minutes
- 10 minutes
- 15 minutes
- 30 minutes
- 1 hour
- 1 day
- 1 week

2c For each selected notification type, select the lowest severity level for which a notification should be sent. Security events are logged and the notifications are sent at the time indicated by the interval when events are equal to or greater than the selected severity level. If the interval is *1 day*, the notification is sent daily, if security events occur.

NOTE: Severity Levels

Novell AppArmor sends out event messages for things that are in the severity database and above the level selected. Severity levels are numbered 1 through 10, with 10 being the most severe security incident. The `/etc/severity.db` file defines the severity level of potential security events. The severity levels are determined by the

importance of different security events, such as certain resources accessed or services denied.

- 3 Click *OK*.
- 4 Click *Done* in the *Novell AppArmor Configuration* window.
- 5 Click *File > Quit* in the YaST Control Center.

After configuring security event notification, read the reports and determine whether events require follow up. Follow up may include the procedures outlined in Section 27.5, “Reacting to Security Event Rejections” (page 358).

27.3 Configuring Reports

Novell AppArmor's reporting feature adds flexibility by enhancing the way users can view security event data. The reporting tool performs the following:

- Creates on-demand reports
- Exports reports
- Schedules periodic reports for archiving
- E-mails periodic reports
- Filters report data by date
- Filters report data by other options, such as program name

Using reports, you can read important Novell AppArmor security events reported in the log files without manually sifting through the messages only useful to the `aa-logprof` tool. Narrow down the size of the report by filtering by date range or program name. You can also export an `html` or `csv` file.

The following are the three types of reports available in Novell AppArmor:

Executive Security Summary

A combined report, consisting of one or more security incident reports from one or more machines. This report can provide a single view of security events on multiple machines. For more details, refer to Section “Executive Security Summary” (page 347).

Application Audit Report

An auditing tool that reports which application servers are running and whether the applications are confined by AppArmor. Application servers are applications that accept incoming network connections. For more details, refer to Section “Application Audit Report” (page 343).

Security Incident Report

A report that displays application security for a single host. It reports policy violations for locally confined applications during a specific time period. You can edit and customize this report or add new versions. For more details, refer to Section “Security Incident Report” (page 345).

To use the Novell AppArmor reporting features, proceed with the following steps:

- 1** Open *YaST > Novell AppArmor*.
- 2** In *Novell AppArmor*, click *AppArmor Reports*. The *AppArmor Security Event Reports* window appears. From the *Reports* window, select an option and proceed to the respective section for instructions:

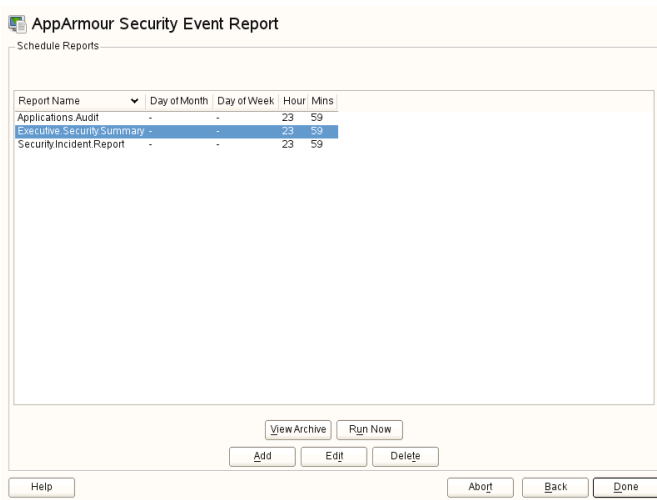

View Archive

Displays all reports that have been run and stored in `/var/log/apparmor/reports-archived/`. Select the report you want to see in detail and click *View*. For *View Archive* instructions, proceed to Section 27.3.1, “Viewing Archived Reports” (page 340).

Run Now

Produces an instant version of the selected report type. If you select a security incident report, it can be further filtered in various ways. For *Run Now* instructions, proceed to Section 27.3.2, “Run Now: Running On-Demand Reports” (page 348).

Add

Creates a scheduled security incident report. For *Add* instructions, proceed to Section 27.3.3, “Adding New Reports” (page 350).

Edit

Edits a scheduled security incident report.

Delete

Deletes a scheduled security incident report. All stock or canned reports cannot be deleted.

Back

Returns you to the Novell AppArmor main screen.

Abort

Returns you to the Novell AppArmor main screen.

Next

Performs the same function as the *Run Now* button.

27.3.1 Viewing Archived Reports

View Reports enables you to specify the location of a collection of reports from one or more systems, including the ability to filter by date or names of programs accessed and display them all together in one report.

- 1 From the *AppArmor Security Event Report* window, select *View Archive*.

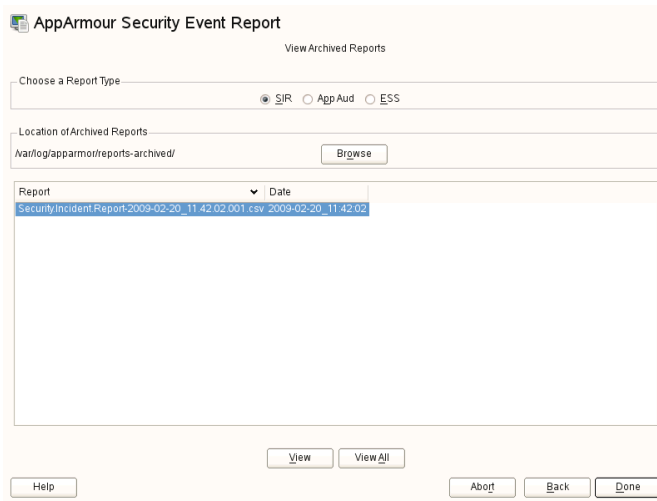

The screenshot shows the 'AppArmor Security Event Report' window with the 'View Archived Reports' section active. The window title is 'AppArmor Security Event Report'. Below the title, it says 'View Archived Reports'. There are three radio buttons for 'Choose a Report Type': 'SIR' (selected), 'App Aud', and 'ESS'. Below that is a text field for 'Location of Archived Reports' containing '/var/log/apparmor/reports-archived/' and a 'Browse' button. A table with columns 'Report' and 'Date' is shown, with one row selected: 'SecurityIncidentReport-2009-02-20_11.42.02.001.csv' and '2009-02-20_11.42.02'. At the bottom, there are buttons for 'View', 'View All', 'Help', 'Abort', 'Back', and 'Done'.

- 2 Select the report type to view. Toggle between the different types: *SIR* (Security Incident Report), *App Aud* (Application Audit), and *ESS* (Executive Security Summary).

- 3 You can alter the directory location of the archived reports in *Location of Archived Reports*. Select *Accept* to use the current directory or select *Browse* to find a new report location. The default directory is `/var/log/apparmor/reports-archived`.
- 4 To view all the reports in the archive, select *View All*. To view a specific report, select a report file listed in the *Report* field then select *View*.
- 5 For *Application Audit* and *Executive Security Summary* reports, proceed to Step 9 (page 343).
- 6 The *Report Configuration Dialog* opens for *Security Incident* reports.

- 7 The *Report Configuration* dialog enables you to filter the reports selected in the previous screen. Enter the desired filter details. The fields are:

Date Range

To display reports for a certain time period, select *Filter By Date Range*. Enter the start and end dates that define the scope of the report.

Program Name

When you enter a program name or pattern that matches the name of the binary executable of the program of interest, the report displays security events that have occurred for a specific program.

Profile Name

When you enter the name of the profile, the report displays the security events that are generated for the specified profile. You can use this to see what is being confined by a specific profile.

PID Number

PID number is a number that uniquely identifies one specific process or running program (this number is valid only during the lifetime of that process).

Severity

Select the lowest severity level for security events to include in the report. The selected severity level (and above) are then included in the reports.

Detail

A source to which the profile has denied access. This includes capabilities and files. You can use this field to report the resources to which profiles prevent access.

Access Type

The access type describes what is actually happening with the security event. The options are `PERMITTING`, `REJECTING`, or `AUDITING`.

Mode

The *Mode* is the permission that the profile grants to the program or process to which it is applied. The options are `a11` (all modes without filtering), `r` (read), `w` (write), `l` (link), `x` (execute), and `m` (mmap).

Export Type

Enables you to export a CSV (comma separated values) or HTML file. The CSV file separates pieces of data in the log entries with commas using a standard data format for importing into table-oriented applications. You can enter a path for your exported report by typing the full path in the field provided.

Location to Store Log

Enables you to change the location at which to store the exported report. The default location is `/var/log/apparmor/reports-exported`. When you change this location, select *Accept*. Select *Browse* to browse the file system.

- 8 To see the report, filtered as desired, select *Next*. One of the three reports displays.
- 9 Refer to the following sections for detailed information about each type of report.
 - For the application audit report, refer to Section “Application Audit Report” (page 343).
 - For the security incident report, refer to Section “Security Incident Report” (page 345).
 - For the executive summary report, refer to Section “Executive Security Summary” (page 347).

Application Audit Report

An application audit report is an auditing tool that reports which application servers are running and whether they are confined by AppArmor.

AppArmor On-Demand Report

Applications Audit Report

Host	Date	Program	Profile	PID	State	Type
bourbaki	Fri Feb 20 11:47:46 2009	/usr/bin/vnc	-	3172	not-confined	-
bourbaki	Fri Feb 20 11:47:46 2009	/usr/bin/vnc	-	3172	not-confined	-
bourbaki	Fri Feb 20 11:47:46 2009	/usr/bin/vnc	-	3172	not-confined	-
bourbaki	Fri Feb 20 11:47:46 2009	/usr/sbin/cupsd	-	11575	not-confined	-
bourbaki	Fri Feb 20 11:47:46 2009	/usr/sbin/cupsd	-	11575	not-confined	-
bourbaki	Fri Feb 20 11:47:46 2009	/usr/sbin/cupsd	-	11575	not-confined	-
bourbaki	Fri Feb 20 11:47:46 2009	/sbin/rpcbind	-	13839	not-confined	-
bourbaki	Fri Feb 20 11:47:46 2009	/sbin/rpcbind	-	13839	not-confined	-
bourbaki	Fri Feb 20 11:47:46 2009	/sbin/rpcbind	-	13839	not-confined	-
bourbaki	Fri Feb 20 11:47:46 2009	/sbin/rpcbind	-	13839	not-confined	-
bourbaki	Fri Feb 20 11:47:46 2009	/sbin/rpcbind	-	13839	not-confined	-
bourbaki	Fri Feb 20 11:47:46 2009	/usr/sbin/gdm	-	14311	not-confined	-
bourbaki	Fri Feb 20 11:47:46 2009	/usr/sbin/ssh	-	14371	not-confined	-
bourbaki	Fri Feb 20 11:47:46 2009	/usr/sbin/ssh	-	14371	not-confined	-
bourbaki	Fri Feb 20 11:47:46 2009	/usr/sbin/xinetd	-	14404	not-confined	-
bourbaki	Fri Feb 20 11:47:46 2009	/usr/sbin/xinetd	-	14404	not-confined	-
bourbaki	Fri Feb 20 11:47:46 2009	/usr/lib/postfix/master	-	14426	not-confined	-

The following fields are provided in an application audit report:

Host

The machine protected by AppArmor for which the security events are reported.

Date

The date during which security events occurred.

Program

The name and path of the executing process.

Profile

The absolute name of the security profile that is applied to the process.

PID

A number that uniquely identifies one specific process or running program (this number is valid only during the lifetime of that process).

State

This field reveals whether the program listed in the program field is confined. If it is not confined, consider creating a profile for it.

Type

This field reveals the type of confinement the security event represents (either complain or enforce). If the application is not confined (state), no type of confinement is reported.

Security Incident Report

A security incident report displays security events of interest to an administrator. The SIR reports policy violations for locally confined applications during a specified time period. It also reports policy exceptions and policy engine state changes. These two types of security events are defined as follows:

Policy Exceptions

When an application requests a resource that is not defined within its profile, a security event is triggered. A report is generated that displays security events of interest to an administrator. The SIR reports policy violations for locally confined applications during a specified time period. The SIR reports policy exceptions and policy engine state changes.

Policy Engine State Changes

Enforces policy for applications and maintains its own state, including when engines start or stop, when a policy is reloaded, and when global security features are enabled or disabled.

AppArmor On-Demand Report

On Demand Event Report - Page 1 of 1

Host	Date	Program	Profile	PID	Severity	Mode Request	Mode Deny	Detail	Event
bourbaki	2009-02-20 13:24:39	/usr/sbin/httpd2-prefork	/usr/sbin/httpd2-prefork	6667	U	r::	r::	-	REJEC
bourbaki	2009-02-20 13:24:39	/etc/apache2/httpd.conf	/usr/sbin/httpd2-prefork	6667	3	r::	r::	-	REJEC

The fields in the SIR report have the following meanings:

Host

The machine protected by AppArmor for which the security events are reported.

Date

The date during which security events occurred.

Program

The name of the executing process.

Profile

The absolute name of the security profile that is applied to the process.

PID

A number that uniquely identifies one specific process or running program (this number is valid only during the lifetime of that process).

Severity

Severity levels of events are reported from the severity database. The severity database defines the importance of potential security events and numbers them 1 through 10, 10 being the most severe security incident. The severity levels are de-

terminated by the threat or importance of different security events, such as certain resources accessed or services denied.

Mode

The mode is the permission that the profile grants to the program or process to which it is applied. The options are `r` (read), `w` (write), `l` (link), and `x` (execute).

Detail

A source to which the profile has denied access. This includes capabilities and files. You can use this field to report the resources to which the profile prevents access.

Access Type

The access type describes what is actually happening with the security event. The options are `PERMITTING`, `REJECTING`, or `AUDITING`.

Executive Security Summary

A combined report consisting of one or more high-level reports from one or more machines. This report can provide a single view of security events on multiple machines as long as each machine's data is copied to the report archive directory, which is `/var/log/apparmor/reports-archived`. One line of the ESS report represents a range of SIR reports.

The following fields are provided in an executive security summary:

Host

The machine protected by AppArmor for which the security events are reported.

Start Date

The first date in a range of dates during which security events are reported.

End Date

The last date in a range of dates during which security events are reported.

Num Rejects

In the date range given, the total number of security events that are rejected access attempts.

Num Events

In the date range given, the total number of security events.

Ave. Sev

This is the average of the severity levels reported in the date range given. Unknown severities are disregarded in this figure.

High Sev

This is the severity of the highest severity event reported in the date range given.

27.3.2 Run Now: Running On-Demand Reports

The *Run Now* report feature enables you to instantly extract report information from the Novell AppArmor event logs without waiting for scheduled events. If you need help navigating to the main report screen, see Section 27.3, “Configuring Reports” (page 337). Perform the following steps to run a report from the list of reports:

- 1 Select the report to run instantly from the list of reports in the *Schedule Reports* window.
- 2 Select *Run Now* or *Next*. The next screen is dependent on which report you selected in the previous step. As an example, select a security incident report.
- 3 The *Report Configuration Dialog* opens for security incident reports.

The screenshot shows the 'Report Configuration Dialogue' window. At the top, there is a checkbox for 'Filter By Date Range' and a 'Select Date Range' section. This section contains two rows of date pickers: 'Enter Starting Date/Time' and 'Enter Ending Date'. Each row has fields for Hours, Minutes, Day, Month, and Year. Below the date pickers, there are four input fields: 'Program name', 'Profile name', 'PID number', and 'Severity'. The 'Severity' field has a dropdown menu currently set to 'All'. Underneath these fields, there is a 'Detail' field and an 'Access Type' field with a dropdown set to 'R'. To the right of 'Access Type' is a 'Mode' field with a dropdown set to 'All'. At the bottom, there is an 'Export Type' dropdown set to 'None' and a 'Location to store log' text field containing '/var/log/apparmor/reports-exported'. A 'Browse' button is located to the right of the location field. At the very bottom, there are three buttons: 'Help', 'About', and 'Next'.

- 4 The *Report Configuration Dialog* enables you to filter the reports selected in the previous screen. Enter the desired filter details. The following filter options are available:

Date Range

To limit reports to a certain time period, select *Filter By Date Range*. Enter the start and end dates that determine the scope of the report.

Program Name

When you enter a program name or pattern that matches the name of the binary executable for the relevant program, the report displays security events that have occurred for that program only.

Profile Name

When you enter the name of the profile, the report displays the security events that are generated for the specified profile. You can use this to see what is confined by a specific profile.

PID Number

A number that uniquely identifies one specific process or running program (this number is valid only during the lifetime of that process).

Severity

Select the lowest severity level for security events to include in the report. The selected severity level and above are included in the reports.

Detail

A source to which the profile has denied access. This includes capabilities and files. You can use this field to report the resources to which profiles prevent access.

Access Type

The access type describes the action being taken with the security event. The options are `PERMITTING`, `REJECTING`, or `AUDITING`.

Mode

The mode is the permission that the profile grants to the program or process to which it is applied. The options are `r` (read), `w` (write), `l` (link), and `x` (execute).

Export Type

Enables you to export a CSV (comma separated values) or HTML file. The CSV file separates pieces of data in the log entries with commas, using a standard data format for importing into table-oriented applications. Enter a path for your exported report by typing in the full path in the field provided.

Location to Store Log

Enables you to change the location that the exported report is stored. The default location is `/var/log/apparmor/reports-exported`. When you change this location, select *Accept*. Select *Browse* to browse the file system.

5 To see the report, filtered as desired, select *Next*. One of the three reports displays.

Refer the following sections for detailed information about each type of report.

- For the application audit report, refer to Section “Application Audit Report” (page 343).
- For the security incident report, refer to Section “Security Incident Report” (page 345).
- For the executive summary report, refer to Section “Executive Security Summary” (page 347).

27.3.3 Adding New Reports

Adding new reports enables you to create a scheduled security incident report that displays Novell AppArmor security events according to your preset filters. When a report is set up in *Schedule Reports*, it periodically launches a report of Novell AppArmor security events that have occurred on the system.

You can configure a daily, weekly, monthly, or hourly report to run for a specified period. You can set the report to display rejections for certain severity levels or to filter by program name, profile name, severity level, or denied resources. This report can be exported to an HTML (Hypertext Markup Language) or CSV (Comma Separated Values) file format.

NOTE

Return to the beginning of this section if you need help navigating to the main report screen (see Section 27.3, “Configuring Reports” (page 337)).

To add a new scheduled security incident report, proceed as follows:

- 1 Click *Add* to create a new security incident report. The first page of *Add Scheduled SIR* opens.

Add Scheduled SIR

Report Name
My Report

Day of Month Day of Week Hour Minute
All All 0 5

Email Target 1 Email Target 2 Email Target 3
tux@example.com

Export Type Location to store log.
None /var/log/apparmor/reports-exported Browse

Cancel Next

- 2 Fill in the fields with the following filtering information, as necessary:

Report Name

Specify the name of the report. Use names that easily distinguish different reports.

Day of Month

Select any day of the month to activate monthly filtering in reports. If you select `All`, monthly filtering is not performed.

Day of Week

Select the day of the week on which to schedule weekly reports, if desired. If you select `ALL`, weekly filtering is not performed. If monthly reporting is selected, this field defaults to `ALL`.

Hour and Minute

Select the time. This specifies the hour and minute that you would like the reports to run. If you do not change the time, selected reports run at midnight. If neither month nor day of week are selected, the report runs daily at the specified time.

E-Mail Target

You have the ability to send the scheduled security incident report via e-mail to up to three recipients. Just enter the e-mail addresses for those who require the security incident information.

Export Type

This option enables you to export a CSV (comma separated values) or HTML file. The CSV file separates pieces of data in the log entries with commas using a standard data format for importing into table-oriented applications. Enter a path for your exported report by typing in the full path in the field provided.

Location to Store Log

Enables you to change the location where the exported report is stored. The default location is `/var/log/apparmor/reports-exported`. When you change this location, select *Accept*. Select *Browse* to browse the file system.

- 3 Click *Next* to proceed to the second page of *Add Scheduled SIR*.

Program name	Profile name	
<input type="text" value="sshd"/>	<input type="text"/>	
PID number	Detail	
<input type="text"/>	<input type="text"/>	
Severity	Access Type:	Mode:
<input type="button" value="All"/>	<input type="button" value="R"/>	<input type="button" value="All"/>
<input type="button" value="Cancel"/>		<input type="button" value="Save"/>

4 Fill in the fields with the following filtering information, as necessary:

Program Name

You can specify a program name or pattern that matches the name of the binary executable for the program of interest. The report displays security events that have occurred for the specified program only.

Profile Name

You can specify the name of the profile for which the report should display security events. You can use this to see what is being confined by a specific profile.

PID Number

A number that uniquely identifies one specific process or running program (this number is valid only during the lifetime of that process).

Detail

A source to which the profile has denied access. This includes capabilities and files. You can use this field to create a report of resources to which profiles prevent access.

Severity

Select the lowest severity level of security events to include in the report. The selected severity level and above are included in the reports.

Access Type

The access type describes the action being taken with the security event. The options are `PERMITTING`, `REJECTING`, or `AUDITING`.

Mode

The mode is the permission that the profile grants to the program or process to which it is applied. The options are `r` (read), `w` (write), `l` (link), and `x` (execute).

5 Click *Save* to save this report. Novell AppArmor returns to the *Scheduled Reports* main window where the newly scheduled report appears in the list of reports.

27.3.4 Editing Reports

From the AppArmor *Reports* screen, you can select and edit a report. The three pre-configured reports (*stock reports*) cannot be edited or deleted.

NOTE

Return to the beginning of this section if you need help navigating to the main report screen (see Section 27.3, “Configuring Reports” (page 337)).

Perform the following steps to modify a report from the list of reports:

- 1 From the list of reports in the *Schedule Reports* window, select the report to edit. This example assumes that you have selected a security incident report.
- 2 Click *Edit* to edit the security incident report. The first page of the *Edit Scheduled SIR* displays.

The screenshot shows a dialog box titled "Edit Report Schedule for Security.Incident.Report". It contains several input fields and buttons:

- Day of Month:** A dropdown menu with "All" selected.
- Day of Week:** A dropdown menu with "All" selected.
- Hour:** A text input field containing "23".
- Minute:** A text input field containing "59".
- Email Target 1, 2, 3:** Three empty text input fields.
- Export Type:** A dropdown menu with "Both" selected.
- Location to store log:** A text input field containing "/var/log/apparmor/reports-archived".
- Buttons:** "Cancel" and "Next" buttons at the bottom.

- 3 Modify the following filtering information, as necessary:

Day of Month

Select any day of the month to activate monthly filtering in reports. If you select `All`, monthly filtering is not performed.

Day of Week

Select the day of the week on which to schedule the weekly reports. If you select `All`, weekly filtering is not performed. If monthly reporting is selected, this defaults to `All`.

Hour and Minute

Select the time. This specifies the hour and minute that you would like the reports to run. If you do not change the time, the selected report runs at midnight. If neither the day of the month nor day of the week is selected, the report runs daily at the specified time.

E-Mail Target

You have the ability to send the scheduled security incident report via e-mail to up to three recipients. Just enter the e-mail addresses for those who require the security incident information.

Export Type

This option enables you to export a CSV (comma separated values) or HTML file. The CSV file separates pieces of data in the log entries with commas, using a standard data format for importing into table-oriented applications. Enter a path for your exported report by typing the full path in the field provided.

Location to Store Log

Enables you to change the location where the exported report is stored. The default location is `/var/log/apparmor/reports-exported`. When you change this location, select *Accept*. Select *Browse* to browse the file system.

- 4 Click *Next* to proceed to the next *Edit Scheduled SIR* page. The second page of *Edit Scheduled Reports* opens.

The screenshot shows a form with the following fields and controls:

- Program name:** A text input field containing "httpd2-prefork".
- Profile name:** An empty text input field.
- PID number:** An empty text input field.
- Detail:** An empty text input field.
- Severity:** A dropdown menu with "All" selected.
- Access Type:** A button with "R" selected.
- Mode:** A button with "All" selected.
- Buttons:** "Cancel" and "Save" buttons at the bottom.

5 Modify the fields with the following filtering information, as necessary:

Program Name

You can specify a program name or pattern that matches the name of the binary executable for the program of interest. The report displays security events that have occurred for the specified program only.

Profile Name

You can specify the name of the profile for which to display security events. You can use this to see what is being confined by a specific profile.

PID Number

Process ID number is a number that uniquely identifies one specific process or running program (this number is valid only during the lifetime of that process).

Detail

A source to which the profile has denied access. This includes capabilities and files. You can use this field to create a report of resources to which profiles prevent access.

Severity

Select the lowest severity level for security events to include in the report. The selected severity level and above are included in the reports.

Access Type

The access type describes the action being taken with the security event. The options are `PERMITTING`, `REJECTING`, or `AUDITING`.

Mode

The mode is the permission that the profile grants to the program or process to which it is applied. The options are `r` (read), `w` (write), `l` (link), and `x` (execute).

6 Select *Save* to save the changes to this report. Novell AppArmor returns to the *Scheduled Reports* main window where the scheduled report appears in the list of reports.

27.3.5 Deleting Reports

Delete a Report enables you to permanently remove a report from the list of Novell AppArmor scheduled reports. To delete a report, follow these instructions:

- 1 To remove a report from the list of reports, highlight the report and click *Delete*.
- 2 From the confirmation pop-up, select *Cancel* if you do not want to delete the selected report. If you are sure you want to remove the report permanently from the list of reports, select *Delete*.

27.4 Configuring and Using the AppArmor Desktop Monitor Applet

The Linux audit framework contains a dispatcher that can send AppArmor events to any consumer application via dbus. The GNOME AppArmor Desktop Monitor applet is one example of an application that gathers AppArmor events via dbus. To configure audit to use the dbus dispatcher, just set the dispatcher in your audit configuration in `/etc/audit/auditd.conf` to `apparmor-dbus` and restart `auditd`:

```
dispatcher=/usr/bin/apparmor-dbus
```

Once the dbus dispatcher is configured correctly, add the AppArmor Desktop Monitor to the GNOME panel by right-clicking the panel and selecting *Add to Panel > AppArmor Desktop Monitor*. As soon as a `REJECT` event is logged, the applet's panel icon changes appearance and you can click the applet to see the number of reject events per confined application. To view the exact log messages, refer to the audit log under `/var/log/audit/audit.log`. React to any `REJECT` events as described in Section 27.5, “Reacting to Security Event Rejections” (page 358).

27.5 Reacting to Security Event Rejections

When you receive a security event rejection, examine the access violation and determine if that event indicated a threat or was part of normal application behavior. Application-specific knowledge is required to make the determination. If the rejected action is part of normal application behavior, run `aa-logprof` at the command line or the *Update Profile Wizard* in Novell AppArmor to update your profile.

If the rejected action is not part of normal application behavior, this access should be considered a possible intrusion attempt (that was prevented) and this notification should be passed to the person responsible for security within your organization.

27.6 Maintaining Your Security Profiles

In a production environment, you should plan on maintaining profiles for all of the deployed applications. The security policies are an integral part of your deployment. You should plan on taking steps to back up and restore security policy files, plan for software changes, and allow any needed modification of security policies that your environment dictates.

27.6.1 Backing Up Your Security Profiles

Backing up profiles might save you from having to reprofile all your programs after a disk crash. Also, if profiles are changed, you can easily restore previous settings by using the backed up files.

Back up profiles by copying the profile files to a specified directory.

- 1 You should first archive the files into one file. To do this, open a terminal window and enter the following as `root`:

```
tar zcJpf profiles.tgz /etc/apparmor.d
```

The simplest method to ensure that your security policy files are regularly backed up is to include the directory `/etc/apparmor.d` in the list of directories that your backup system archives.

- 2 You can also use `scp` or a file manager like Konqueror or Nautilus to store the files on some kind of storage media, the network, or another computer.

27.6.2 Changing Your Security Profiles

Maintenance of security profiles includes changing them if you decide that your system requires more or less security for its applications. To change your profiles in Novell AppArmor, refer to Section 23.3, “Editing Profiles” (page 281).

27.6.3 Introducing New Software into Your Environment

When you add a new application version or patch to your system, you should always update the profile to fit your needs. You have several options, depending on your company's software deployment strategy. You can deploy your patches and upgrades into a test or production environment. The following explains how to do this with each method.

If you intend to deploy a patch or upgrade in a test environment, the best method for updating your profiles is one of the following:

- Run the profiling wizard by selecting *Add Profile Wizard* in YaST. This creates a new profile for the added or patched application. For step-by-step instructions, refer to Section 23.1, “Adding a Profile Using the Wizard” (page 273).
- Run `aa-genprof` by typing `aa-genprof` in a terminal while logged in as `root`. For detailed instructions, refer to Section “aa-genprof—Generating Profiles” (page 301).

If you intend to deploy a patch or upgrade directly into a production environment, the best method for updating your profiles is one of the following:

- Monitor the system frequently to determine if any new rejections should be added to the profile and update as needed using `aa-logprof`. For detailed instructions, refer to Section “aa-logprof—Scanning the System Log” (page 310).
- Run the YaST *Update Profile Wizard* to learn the new behavior (high security risk as all accesses are allowed and logged, not rejected). For step-by-step instructions, refer to Section 23.5, “Updating Profiles from Log Entries” (page 287).

Support

This chapter outlines maintenance-related tasks. Learn how to update Novell® AppArmor and get a list of available man pages providing basic help for using the command line tools provided by Novell AppArmor. Use the troubleshooting section to learn about some common problems encountered with Novell AppArmor and their solutions. Report defects or enhancement requests for Novell AppArmor following the instructions in this chapter.

28.1 Updating Novell AppArmor Online

Updates for Novell AppArmor packages are provided in the same way as any other update for SUSE Linux Enterprise Server. Retrieve and apply them exactly like for any other package that ships as part of SUSE Linux Enterprise Server.

28.2 Using the Man Pages

There are man pages available for your use. In a terminal, enter `man apparmor` to open the apparmor man page. Man pages are distributed in sections numbered 1 through 8. Each section is specific to a category of documentation:

Table 28.1 *Man Pages: Sections and Categories*

Section	Category
1	User commands
2	System calls
3	Library functions
4	Device driver information
5	Configuration file formats
6	Games
7	High level concepts
8	Administrator commands

The section numbers are used to distinguish man pages from each other. For example, `exit(2)` describes the `exit` system call, while `exit(3)` describes the `exit` C library function.

The Novell AppArmor man pages are:

- `unconfined(8)`
- `autodep(1)`
- `complain(1)`
- `enforce(1)`
- `genprof(1)`
- `logprof(1)`
- `change_hat(2)`

- `logprof.conf` (5)
- `apparmor.conf` (5)
- `apparmor.d` (5)
- `apparmor.vim` (5)
- `apparmor` (7)
- `apparmor_parser` (8)

28.3 For More Information

Find more information about the AppArmor product on the Novell AppArmor product page at Novell: <http://www.novell.com/products/apparmor/>. Find the product documentation for Novell AppArmor, including this document, at <http://www.novell.com/documentation/apparmor/> or in the installed system in `/usr/share/doc/manual`.

There are specific mailing lists for AppArmor that users can post to or join to communicate with developers.

`apparmor-general@forge.novell.com` [<mailto:apparmor-general@forge.novell.com>]

This is a mailing list for end users of AppArmor. It is a good place for questions about how to use AppArmor to protect your applications.

`apparmor-dev@forge.novell.com` [<mailto:apparmor-dev@forge.novell.com>]

This is a developer mailing list for AppArmor developers and community members. This list is for questions about development of core AppArmor features—the kernel module and the profiling tools. If you are interested in reviewing the code for AppArmor and contributing reviews or patches, this would be the list for you.

`apparmor-announce@forge.novell.com` [<mailto:apparmor-announce@forge.novell.com>]

This is a low traffic list announcing the availability of new releases or features.

28.4 Troubleshooting

This section lists the most common problems and error messages that may occur using Novell AppArmor.

28.4.1 How to React to odd Application Behavior?

If you notice odd application behavior or any other type of application problem, you should first check the reject messages in the log files to see if AppArmor is too closely constricting your application. To check reject messages, start *YaST* > *Novell AppArmor* and go to *AppArmor Reports*. Select *View Archive* and *App Aud* for the application audit report. You can filter dates and times to narrow down the specific periods when the unexpected application behavior occurred.

If you detect reject messages that indicate that your application or service is too closely restricted by AppArmor, update your profile to properly handle your use case of the application. Do this with the *Update Profile Profile Wizard* in YaST, as described in Section 23.5, “Updating Profiles from Log Entries” (page 287).

If you decide to run your application or service without AppArmor protection, remove the application's profile from `/etc/apparmor.d` or move it to another location.

28.4.2 My Profiles do not Seem to Work Anymore ...

If you have been using previous versions of AppArmor and have updated your system (but kept your old set of profiles) you might notice some applications which seemed to work perfectly before you updated behaving strangely, or not working at all .

This version of AppArmor introduces a set of new features to the profile syntax and the AppArmor tools that might cause trouble with older versions of the AppArmor profiles. Those features are:

- File Locking

- Network Access Control
- The `SYS_PTRACE` Capability
- Directory Path Access

The current version of AppArmor mediates file locking and introduces a new permission mode (`k`) for this. Applications requesting file locking permission might misbehave or fail altogether if confined by older profiles which do not explicitly contain permissions to lock files. If you suspect this being the case, check the log file under `/var/log/audit/audit.log` for entries like the following:

```
type=APPARMOR_DENIED msg=audit(1188913493.299:9304): operation="file_lock"
requested_mask="::k" denied_mask="::k" fsuid=1000
name="/home/tux/.qt/.qtrc.lock" pid=25736 profile="/usr/bin/opera"
```

Update the profile using the YaST Update Profile Wizard or the `aa-logprof` command as outlined below.

The new network access control syntax based on the network family and type specification, described in Section 21.5, “Network Access Control” (page 251), might cause application misbehavior or even stop applications from working. If you notice a network-related application behaving strangely, check the log file under `/var/log/audit/audit.log` for entries like the following:

```
type=APPARMOR_DENIED msg=audit(1188894313.206:9123): operation="socket_create"
family="inet" sock_type="raw" protocol=1 pid=23810 profile="/bin/ping"
```

This log entry means that our example application, `/bin/ping` in this case, failed to get AppArmor's permission to open a network connection. This permission has to be explicitly stated to make sure that an application has network access. To update the profile to the new syntax, use the YaST Update Profile Wizard or the `aa-logprof` command as outlined below.

The current kernel requires the `SYS_PTRACE` capability, if a process tries to access files in `/proc/pid/fd/*`. New profiles need an entry for the file and the capability, where old profiles only needed the file entry. For example:

```
/proc*/fd/** rw,
```

in the old syntax would translate to the following rules in the new syntax:

```
capability SYS_PTRACE,  
/proc*/fd/** rw,
```

To update the profile to the new syntax, use the YaST Update Profile Wizard or the `aa-logprof` command as outlined below.

With this version of AppArmor, a few changes have been made to the profile rule syntax to better distinguish directory from file access. Therefore, some rules matching both file and directory paths in the previous version might now just match a file path. This could lead to AppArmor not being able to access a crucial directory at all, and thus trigger misbehavior of your application and various log messages. The following examples highlight the most important changes to the path syntax.

Using the old syntax, the following rule would allow access to files and directories in `/proc/net`. It would allow directory access only to read the entries in the directory, but not give access to files or directories under the directory, e.g. `/proc/net/dir/foo` would be matched by the asterisk (*), but as `foo` is a file or directory under `dir`, it cannot be accessed.

```
/proc/net/* r,
```

To get the same behavior using the new syntax, you need two rules instead of one. The first allows access to the file under `/proc/net` and the second allows access to directories under `/proc/net`. Directory access can only be used for listing the contents, not actually accessing files or directories underneath the directory.

```
/proc/net/* r,  
/proc/net/*/ r,
```

The following rule works similarly both under the old and the new syntax, and allows access to both files and directories under `/proc/net`:

```
/proc/net/** r,
```

To distinguish file access from directory access using the above expression in the new syntax, use the following two rules. The first one only allows to recursively access directories under `/proc/net` while the second one explicitly allows for recursive file access only.

```
/proc/net/**/ r,  
/proc/net/**[^/] r,
```

The following rule works similarly both under the old and the new syntax and allows access to both files and directories beginning with `foo` under `/proc/net`:

```
/proc/net/foo** r,
```

To distinguish file access from directory access in the new syntax and use the `**` globbing pattern, use the following two rules. The first one would have matched both files and directories in the old syntax, but only matches files in the new syntax due to the missing trailing slash. The second rule matched neither file nor directory in the old syntax, but matches directories only in the new syntax:

```
/proc/net/**foo r,  
/proc/net/**foo/ r,
```

The following rules illustrate how the use of the `?` globbing pattern has changed. In the old syntax, the first rule would have matched both files and directories (four characters, last character could be any but a slash). In the new syntax, it matches only files (trailing slash is missing). The second rule would match nothing in the old profile syntax, but matches directories only in the new syntax. The last rule matches explicitly matches a file called `bar` under `/proc/net/foo?`. Using the old syntax, this rule would have applied to both files and directories:

```
/proc/net/foo? r,  
/proc/net/foo?/ r,  
/proc/net/foo?/bar r,
```

To find and resolve issues related to syntax changes, take some time after the update to check the profiles you want to keep and proceed as follows for each application you kept the profile for:

- 1** Make sure that AppArmor is running and that the application's profile is loaded.
- 2** Start the YaST AppArmor Control Panel and put the application's profile into complain mode. Log entries are made for any actions violating the current profile, but the profile is not enforced and the application's behavior not restricted.
- 3** Run the application covering all the tasks you need this application to be able to perform.
- 4** Start the YaST Update Profile Wizard to update the application's profile according to the log entries generated while running the application.

- 5 Once the profile is updated, put it back into enforce mode via the YaST AppArmor Control Panel.

Using the AppArmor command line tools, you would proceed as follows:

- 1 Put the application's profile into complain mode:

```
aa-complain /path/to/application
```

- 2 Run the application.

- 3 Update the profile according to the log entries made while running the application:

```
aa-logprof /path/to/application
```

- 4 Put the resulting profile back into enforce mode:

```
aa-enforce /path/to/application
```

28.4.3 How to Confine KDE Applications with AppArmor?

Currently, it is not possible to confine KDE applications to the same extent as any other application, due to the way KDE manages its processes.

If you want to confine KDE applications, choose one of the following approaches, but note that none of them are really suited for a standard setup:

Create a Single Profile for the Entire KDE Desktop

As all KDE processes are children of one parent process and AppArmor cannot distinguish an individual application's process from the rest, create one huge profile to confine the entire desktop all at once. This approach is only feasible if your setup is a very limited (kiosk-type) one. Maintaining such a profile for a standard KDE desktop (including all of its applications) would be close to impossible.

Modify KDE's process handling

Using `KDE_EXEC_SLAVES=1` and `KDE_IS_PRELINKED=1` variables force KDE to manage its processes in a way that allows AppArmor to distinguish individual applications from each other and apply profiles to them. This approach might slow down your desktop considerably, as it turns off a crucial optimization for speed. Note that the above mentioned environment variables have to be set before KDM/XDM/GDM or startx are started. One way to achieve this would be to add them to `/etc/security/pam_env.conf`.

28.4.4 How to Resolve Issues with Apache?

Apache is not starting properly or it is not serving Web pages and you just installed a new module or made a configuration change. When you install additional Apache modules (like `apache2-mod_apparmor`) or make configuration changes to Apache, you should profile Apache again to catch any additional rules that need to be added to the profile.

28.4.5 Why are the Reports not Sent by E-Mail?

When the reporting feature generates an HTML or CSV file that exceeds the default size, the file is not sent. Mail servers have a default hard limit for e-mail size. This limitation can impede AppArmor's ability to send e-mails that are generated for reporting purposes. If your mail is not arriving, this could be why. Consider the mail size limits and check the archives if e-mails have not been received.

28.4.6 How to Exclude Certain Profiles from the List of Profiles Used?

AppArmor always loads and applies all profiles that are available in its profile directory (`/etc/apparmor.d/`). If you decide not to apply a profile to a certain application, delete the appropriate profile or move it to another location where AppArmor would not check for it.

28.4.7 Can I Manage Profiles for Applications not Installed on my System?

Managing profiles with AppArmor requires you to have access to the log of the system on which the application is running. So you do not need to run the application on your profile, build host as long as you have access to the machine that runs the application. You can run the application on one system, transfer the logs (`/var/log/audit.log` or, if `audit` is not installed, `/var/log/messages`) to your profile build host and run `aa-logprof -f path_to_logfile`.

28.4.8 How to Spot and fix AppArmor Syntax Errors?

Manually editing Novell AppArmor profiles can introduce syntax errors. If you attempt to start or restart AppArmor with syntax errors in your profiles, error results are shown. This example shows the syntax of the entire parser error.

```
localhost:~ # rcapparmor start
Loading AppArmor profiles AppArmor parser error in
/etc/apparmor.d/usr.sbin.squid at line 410: syntax error, unexpected TOK_ID,
expecting TOK_MODE
Profile /etc/apparmor.d/usr.sbin.squid failed to load
```

Using the AppArmor YaST tools, a graphical error message indicates which profile contained the error and requests you to fix it.

Errors found in AppArmor profiles

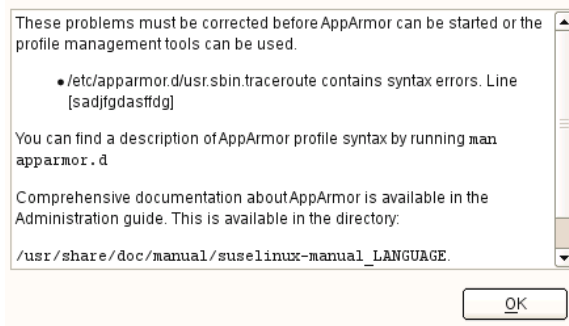

To fix a syntax error, log in to a terminal window as `root`, open the profile, and correct the syntax. Reload the profile set with `rcapparmor reload`.

28.5 Reporting Bugs for AppArmor

The developers of AppArmor are eager to deliver products of the highest quality. Your feedback and your bug reports help us keep the quality high. Whenever you encounter a bug in AppArmor, file a bug report against this product:

- 1 Use your Web browser to go to <https://bugzilla.novell.com/index.cgi>.
- 2 Enter the account data of your Novell account and click *Login*

or

Create a new Novell account as follows:

- 2a Click *Create New Account* on the *Login to Continue* page.
- 2b Provide a username and password and additional address data and click *Create Login* to immediately proceed with the login creation.

or

Provide data on which other Novell accounts you maintain to sync all these to one account.

- 3** Check whether a problem similar to yours has already been reported by clicking *Search Reports*. Use a quick search against a given product and keyword or use the *Advanced Search*.
- 4** If your problem has already been reported, check this bug report and add extra information to it, if necessary.
- 5** If your problem has not been reported yet, select *New* from the top navigation bar and proceed to the *Enter Bug* page.
- 6** Select the product against which to file the bug. In your case, this would be your product's release. Click *Submit*.
- 7** Select the product version, component (AppArmor in this case), hardware platform, and severity.
- 8** Enter a brief headline describing your problem and add a more elaborate description including log files. You may create attachments to your bug report for screen shots, log files, or test cases.
- 9** Click *Submit* after you have entered all the details to send your report to the developers.

AppArmor Glossary

29

Apache

Apache is a freely-available UNIX-based Web server. It is currently the most commonly used Web server on the Internet. Find more information about Apache at the Apache Web site at <http://www.apache.org>.

application firewalling

Novell AppArmor contains applications and limits the actions they are permitted to take. It uses privilege confinement to prevent attackers from using malicious programs on the protected server and even using trusted applications in unintended ways.

attack signature

Pattern in system or network activity that alerts of a possible virus or hacker attack. Intrusion detection systems might use attack signatures to distinguish between legitimate and potentially malicious activity.

By not relying on attack signatures, Novell AppArmor provides "proactive" instead of "reactive" defense from attacks. This is better because there is no window of vulnerability where the attack signature must be defined for Novell AppArmor as it does for products using attack signatures to secure their networks.

GUI

Graphical user interface. Refers to a software front-end meant to provide an attractive and easy-to-use interface between a computer user and application. Its elements include such things as windows, icons, buttons, cursors, and scroll bars.

globbing

Filename substitution.

HIP

Host intrusion prevention. Works with the operating system kernel to block abnormal application behavior in the expectation that the abnormal behavior represents an unknown attack. Blocks malicious packets on the host at the network level before they can “hurt” the application they target.

mandatory access control

A means of restricting access to objects that is based on fixed security attributes assigned to users, files, and other objects. The controls are mandatory in the sense that they cannot be modified by users or their programs.

profile foundation classes

Profile building blocks needed for common application activities, such as DNS lookup and user authentication.

RPM

The RPM Package Manager. An open packaging system available for anyone to use. It works on Red Hat Linux, SUSE Linux Enterprise Server, and other Linux and UNIX systems. It is capable of installing, uninstalling, verifying, querying, and updating computer software packages. See <http://www.rpm.org/> for more information.

SSH

Secure Shell. A service that allows you to access your server from a remote computer and issue text commands through a secure connection.

streamlined access control

Novell AppArmor provides streamlined access control for network services by specifying which files each program is allowed to read, write, and execute. This ensures that each program does what it is supposed to do and nothing else.

URI

Universal resource identifier. The generic term for all types of names and addresses that refer to objects on the World Wide Web. A URL is one kind of URI.

URL

Uniform Resource Locator. The global address of documents and other resources on the World Wide Web.

The first part of the address indicates what protocol to use and the second part specifies the IP address or the domain name where the resource is located.

For example, in `http://www.novell.com`, `http` is the protocol to use.

vulnerabilities

An aspect of a system or network that leaves it open to attack. Characteristics of computer systems that allow an individual to keep it from correctly operating or that allows unauthorized users to take control of the system. Design, administrative, or implementation weaknesses or flaws in hardware, firmware, or software. If exploited, a vulnerability could lead to an unacceptable impact in the form of unauthorized access to information or the disruption of critical processing.

**Part V. *The Linux Audit
Framework***

Understanding Linux Audit

The Linux audit framework as shipped with this version of SUSE Linux Enterprise Server provides a CAPP-compliant (Controlled Access Protection Profiles) auditing system that reliably collects information about any security-relevant event. The audit records can be examined to determine whether any violation of the security policies has been committed, and by whom.

Providing an audit framework is an important requirement for a CC-CAPP/EAL (Common Criteria–Controlled Access Protection Profiles/Evaluation Assurance Level) certification. Common Criteria (CC) for Information Technology Security Information is an international standard for independent security evaluations. Common Criteria helps customers judge the security level of any IT product they intend to deploy in mission-critical setups.

Common Criteria security evaluations have two sets of evaluation requirements, functional and assurance requirements. Functional requirements describe the security attributes of the product under evaluation and are summarized under the Controlled Access Protection Profiles (CAPP). Assurance requirements are summarized under the Evaluation Assurance Level (EAL). EAL describes any activities that must take place for the evaluators to be confident that security attributes are present, effective, and implemented. Examples for activities of this kind include documenting the developers' search for security vulnerabilities, the patch process, and testing.

This guide provides a basic understanding of how audit works and how it can be set up. For more information about Common Criteria itself, refer to the Common Criteria Web site [<http://www.commoncriteriaportal.org/>].

Linux audit helps make your system more secure by providing you with a means to analyze what is happening on your system in great detail. It does not, however, provide additional security itself—it does not protect your system from code malfunctions or any kind of exploits. Instead, Audit is useful for tracking these issues and helps you take additional security measures, like Novell AppArmor, to prevent them.

Audit consists of several components, each contributing crucial functionality to the overall framework. The audit kernel module intercepts the system calls and records the relevant events. The auditd daemon writes the audit reports to disk. Various command line utilities take care of displaying, querying, and archiving the audit trail.

Audit enables you to do the following:

Associate Users with Processes

Audit maps processes to the user ID that started them. This makes it possible for the administrator or security officer to exactly trace which user owns which process and is potentially doing malicious operations on the system.

IMPORTANT: Renaming User IDs

Audit does not handle the renaming of UIDs. Therefore avoid renaming UIDs (for example, changing `tux` from `uid=1001` to `uid=2000`) and make obsolete UIDs rather than renaming them. Otherwise you would need to change `auditctl` data (audit rules) and would have problems retrieving old data correctly.

Review the Audit Trail

Linux audit provides tools that write the audit reports to disk and translate them into human readable format.

Review Particular Audit Events

Audit provides a utility that allows you to filter the audit reports for certain events of interest. You can filter for:

- User
- Group
- Audit ID
- Remote Hostname

- Remote Host Address
- System Call
- System Call Arguments
- File
- File Operations
- Success or Failure

Apply a Selective Audit

Audit provides the means to filter the audit reports for events of interest and also to tune audit to record only selected events. You can create your own set of rules and have the audit daemon record only those of interest to you.

Guarantee the Availability of the Report Data

Audit reports are owned by `root` and therefore only removable by `root`. Unauthorized users cannot remove the audit logs.

Prevent Audit Data Loss

If the kernel runs out of memory, the audit daemon's backlog is exceeded, or its rate limit is exceeded, audit can trigger a shutdown of the system to keep events from escaping audit's control. This shutdown would be an immediate halt of the system triggered by the audit kernel component without any syncing of the latest logs to disk. The default configuration is to log a warning to `syslog` rather than to halt the system.

If the system runs out of disk space when logging, the audit system can be configured to perform clean shutdown (`init 0`). The default configuration tells the audit daemon to stop logging when it runs out of disk space.

30.1 Introducing the Components of Linux Audit

The following figure illustrates how the various components of audit interact with each other:

Figure 30.1 *Introducing the Components of Linux Audit*

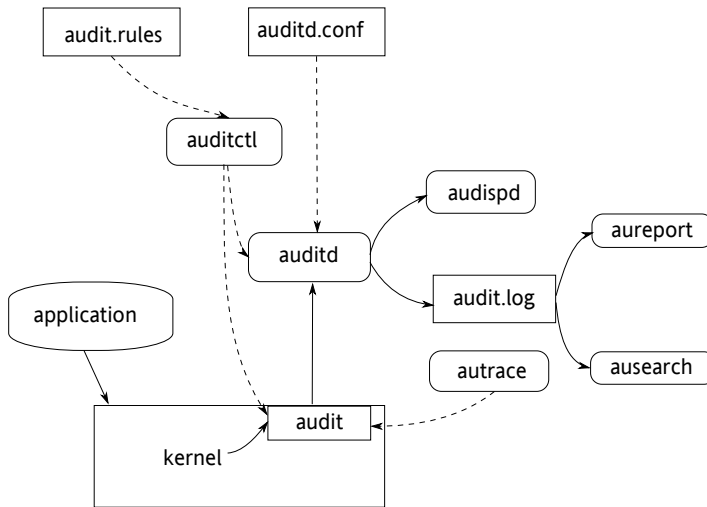

Straight arrows represent the data flow between components while dashed arrows represent lines of control between components.

auditd

The audit daemon is responsible for writing the audit messages that were generated through the audit kernel interface and triggered by application and system activity to disk. The way the audit daemon is started is controlled by its configuration file, `/etc/sysconfig/auditd`. The audit system functions (once started) are controlled by `/etc/audit/auditd.conf`. For more information about `auditd` and its configuration, refer to Section 30.2, “Configuring the Audit Daemon” (page 384).

auditctl

The `auditctl` utility controls the audit system. It controls the log generation parameters and kernel settings of the audit interface as well as the rule sets that determine which events are tracked. For more information about `auditctl`, refer to Section 30.3, “Controlling the Audit System Using `auditctl`” (page 389).

audit rules

The file `/etc/audit/audit.rules` contains a sequence of `auditctl` commands that are loaded at system boot time immediately after the audit daemon is started. For more information about audit rules, refer to Section 30.4, “Passing Parameters to the Audit System” (page 391).

aureport

The `aureport` utility allows you to create custom reports from the audit event log. This report generation can easily be scripted, and the output can be used by various other applications, for example, to plot these results. For more information about `aureport`, refer to Section 30.5, “Understanding the Audit Logs and Generating Reports” (page 395).

ausearch

The `ausearch` utility can search the audit log file for certain events using various keys or other characteristics of the logged format. For more information about `ausearch`, refer to Section 30.6, “Querying the Audit Daemon Logs with `ausearch`” (page 407).

audispd

The audit dispatcher daemon (`audispd`) can be used to relay event notifications to other applications instead of (or in addition to) writing them to disk in the audit log. For more information about `audispd`, refer to Section 30.9, “Relaying Audit Event Notifications” (page 414).

autrace

The `autrace` utility traces individual processes in a fashion similar to `strace`. The output of `autrace` is logged to the audit log. For more information about `autrace`, refer to Section 30.7, “Analyzing Processes with `autrace`” (page 411).

30.2 Configuring the Audit Daemon

Before you can actually start generating audit logs and processing them, configure the audit daemon itself. Configure how it is started in the `/etc/sysconfig/auditd` configuration file and configure how the audit system functions once the daemon has been started in `/etc/audit/auditd.conf`.

The most important configuration parameters in `/etc/sysconfig/auditd` are:

```
AUDITD_LANG="en_US"  
AUDITD_DISABLE_CONTEXTS="no"
```

`AUDITD_LANG`

The locale information used by audit. The default setting is `en_US`. Setting it to `none` would remove all locale information from audit's environment.

`AUDITD_DISABLE_CONTEXTS`

Disable system call auditing by default. Set to `no` for full audit functionality including file and directory watches and system call auditing.

The `/etc/audit/auditd.conf` configuration file determines how the audit system functions once the daemon has been started. For most use cases, the default settings shipped with SUSE Linux Enterprise Server should suffice. For CAPP environments, most of these parameters need tweaking. The following list briefly introduces the parameters available:

```
log_file = /var/log/audit/audit.log  
log_format = RAW  
log_group = root  
priority_boost = 4  
flush = INCREMENTAL  
freq = 20  
num_logs = 4  
disp_qos = lossy  
dispatcher = /usr/sbin/audispd  
name_format = NONE  
#name = mydomain  
max_log_file = 5  
max_log_file_action = ROTATE  
space_left = 75  
space_left_action = SYSLOG  
action_mail_acct = root  
admin_space_left = 50  
admin_space_left_action = SUSPEND  
disk_full_action = SUSPEND
```

```
disk_error_action = SUSPEND

#tcp_listen_port =
tcp_listen_queue = 5
#tcp_client_ports = 1024-65535
tcp_client_max_idle = 0
```

Depending on whether you want your environment to satisfy the requirements of CAPP, you need to be extra restrictive when configuring the audit daemon. Where you need to use particular settings to meet the CAPP requirements, a “CAPP Environment” note tells you how to adjust the configuration.

`log_file`, `log_format` and `log_group`

`log_file` specifies the location where the audit logs should be stored. `log_format` determines how the audit information is written to disk and `log_group` defines the group that owns the log files. Possible values for `log_format` are `raw` (messages are stored just as the kernel sends them) or `nolog` (messages are discarded and not written to disk). The data sent to the audit dispatcher is not affected if you use the `nolog` mode. The default setting is `raw` and you should keep it if you want to be able to create reports and queries against the audit logs using the `aureport` and `ausearch` tools. The value for `log_group` can either be specified literally or by the groups ID.

NOTE: CAPP Environment

In a CAPP environment, have the audit log reside on its own partition. By doing so, you can be sure that the space detection of the audit daemon is accurate and that you do not have other processes consuming this space.

`priority_boost`

Determine how much of a priority boost the audit daemon should get. Possible values are 0 to 4, with 4 assigning the highest priority. The values given here translate to negative nice values, as in 3 to -4 to increase the priority.

`flush` and `freq`

Specifies whether, how, and how often the audit logs should be written to disk. Valid values for `flush` are `none`, `incremental`, `data`, and `sync`. `none` tells the audit daemon not to make any special effort to write the audit data to disk. `incremental` tells the audit daemon to explicitly flush the data to disk. A frequency must be specified if `incremental` is used. A `freq` value of 20 tells the

audit daemon to request that the kernel flush the data to disk after every 20 records. The `data` option keeps the data portion of the disk file in sync at all times while the `sync` option takes care of both metadata and data.

NOTE: CAPP Environment

In a CAPP environment, make sure that the audit trail is always fully up to date and complete. Therefore, use `sync` or `data` with the `flush` parameter.

`num_logs`

Specify the number of log files to keep if you have given `rotate` as the `max_log_file_action`. Possible values range from 0 to 99. A value less than 2 means that the log files are not rotated at all. As you increase the number of files to rotate, you increase the amount of work required of the audit daemon. While doing this rotation, `auditd` cannot always service new data that is arriving from the kernel as quickly, which can result in a backlog condition (triggering `auditd` to react according to the failure flag, described in Section 30.3, “Controlling the Audit System Using `auditctl`” (page 389)). In this situation, increasing the backlog limit is recommended. Do so by changing the value of the `-b` parameter in the `/etc/audit/audit.rules` file.

`disp_qos` and `dispatcher`

The dispatcher is started by the audit daemon during its start. The audit daemon relays the audit messages to the application specified in `dispatcher`. This application must be a highly trusted one, because it needs to run as `root`. `disp_qos` determines whether you allow for `lossy` or `lossless` communication between the audit daemon and the dispatcher. If you choose `lossy`, the audit daemon might discard some audit messages when the message queue is full. These events still get written to disk if `log_format` is set to `raw`, but they might not get through to the dispatcher. If you choose `lossless` the audit logging to disk is blocked until there is an empty spot in the message queue. The default value is `lossy`.

`name_format` and `name`

`name_format` controls how computer names are resolved. Possible values are `none` (no name will be used), `hostname` (value returned by `gethostname`), `fqdn` (full qualified hostname as received per DNS lookup), `numeric` (IP address) and `user`. `user` is a custom string that has to be defined with the `name` parameter.

`max_log_file` and `max_log_file_action`

`max_log_file` takes a numerical value that specifies the maximum file size in megabytes that the log file can reach before a configurable action is triggered. The action to be taken is specified in `max_log_file_action`. Possible values for `max_log_file_action` are `ignore`, `syslog`, `suspend`, `rotate`, and `keep_logs`. `ignore` tells the audit daemon to do nothing once the size limit is reached, `syslog` tells it to issue a warning and send it to syslog, and `suspend` causes the audit daemon to stop writing logs to disk, leaving the daemon itself still alive. `rotate` triggers log rotation using the `num_logs` setting. `keep_logs` also triggers log rotation, but does not use the `num_log` setting, so always keeps all logs.

NOTE: CAPP Environment

To keep a complete audit trail in CAPP environments, the `keep_logs` option should be used. If using a separate partition to hold your audit logs, adjust `max_log_file` and `num_logs` to use the entire space available on that partition. Note that the more files that have to be rotated, the longer it takes to get back to receiving audit events.

`space_left` and `space_left_action`

`space_left` takes a numerical value in megabytes of remaining disk space that triggers a configurable action by the audit daemon. The action is specified in `space_left_action`. Possible values for this parameter are `ignore`, `syslog`, `email`, `exec`, `suspend`, `single`, and `halt`. `ignore` tells the audit daemon to ignore the warning and do nothing, `syslog` has it issue a warning to syslog, and `email` sends an e-mail to the account specified under `action_mail_acct`. `exec` plus a path to a script executes the given script. Note that it is not possible to pass parameters to the script. `suspend` tells the audit daemon to stop writing to disk but remain alive while `single` triggers the system to be brought down to single user mode. `halt` triggers a full shutdown of the system.

NOTE: CAPP Environment

Make sure that `space_left` is set to a value that gives the administrator enough time to react to the alert and allows him to free enough disk space for the audit daemon to continue to work. Freeing disk space would involve

calling `aureport -t` and archiving the oldest logs on a separate archiving partition or resource. The actual value for `space_left` depends on the size of your deployment. Set `space_left_action` to `email`.

`action_mail_acct`

Specify an e-mail address or alias to which any alert messages should be sent. The default setting is `root`, but you can enter any local or remote account as long as e-mail and the network are properly configured on your system and `/usr/lib/sendmail` exists.

`admin_space_left` and `admin_space_left_action`

`admin_space_left` takes a numerical value in megabytes of remaining disk space. The system is already running low on disk space when this limit is reached and the administrator has one last chance to react to this alert and free disk space for the audit logs. The value of `admin_space_left` should be lower than the value for `space_left`. The values for `admin_space_left_action` are the same as for `space_left_action`.

NOTE: CAPP Environment

Set `admin_space_left` to a value that would just allow the administrator's actions to be recorded. The action should be set to `single`.

`disk_full_action`

Specify which action to take when the system runs out of disk space for the audit logs. The possible values are the same as for `space_left_action`.

NOTE: CAPP Environment

As the `disk_full_action` is triggered when there is absolutely no more room for any audit logs, you should bring the system down to single-user mode (`single`) or shut it down completely (`halt`).

`disk_error_action`

Specify which action to take when the audit daemon encounters any kind of disk error while writing the logs to disk or rotating the logs. The possible value are the same as for `space_left_action`.

NOTE: CAPP Environment

Use `syslog`, `single`, or `halt` depending on your site's policies regarding the handling of any kind of hardware failure.

`tcp_listen_port`, `tcp_listen_queue`, `tcp_client_ports` and `tcp_client_max_idle`

The audit daemon can receive audit events from other audit daemons. The `tcp` parameters let you control incoming connections. Specify a port between 1 and 65535 with `tcp_listen_port` on which the `auditd` will listen. `tcp_listen_queue` lets you configure a maximum value for pending connections. Make sure not to set a value too small, since the number of pending connections may be high under certain circumstances, such as after a power outage. `tcp_client_ports` defines which client ports are allowed. Either specify a single port or a port range with numbers separated by a dash (e.g. 1-1023 for all privileged ports). Specifying a single allowed client port may make it difficult for the client to restart their audit subsystem, as it will be unable to recreate a connection with the same host addresses and ports until the connection closure `TIME_WAIT` state times out. If a client does not respond anymore, `auditd` complains. Specify the number of seconds after which this will happen with `tcp_client_max_idle`. Keep in mind that this setting is valid for all clients and therefore should be higher than any individual client heartbeat setting, preferably by a factor of two.

Once the daemon configuration in `/etc/sysconfig/auditd` and `/etc/audit/auditd.conf` is complete, the next step is to focus on controlling the amount of auditing the daemon does, and to assign sufficient resources and limits to the daemon so it can operate smoothly.

30.3 Controlling the Audit System Using `auditctl`

`auditctl` is responsible for controlling the status and some basic system parameters of the audit daemon. It controls the amount of auditing performed on the system. Using audit rules, `auditctl` controls which components of your system are subjected to the audit and to what extent they are audited. Audit rules can be passed to the audit daemon on the `auditctl` command line as well as by composing a rule set and instructing

the audit daemon to process this file. By default, the `rcauditd` script is configured to check for audit rules under `/etc/audit/audit.rules`. For more details on audit rules, refer to Section 30.4, “Passing Parameters to the Audit System” (page 391).

The main `auditctl` commands to control basic audit system parameters are:

- `auditctl -e` to enable or disable audit
- `auditctl -f` to control the failure flag
- `auditctl -r` to control the rate limit for audit messages
- `auditctl -b` to control the backlog limit
- `auditctl -s` to query the current status of the audit daemon

The `-e`, `-f`, `-r`, and `-b` options can also be specified in the `audit.rules` file to avoid having to enter them each time the audit daemon is started.

Any time you query the status of the audit daemon with `auditctl -s` or change the status flag with `auditctl -eflag`, a status message (including information on each of the above-mentioned parameters) is output. The following example highlights the typical audit status message.

Example 30.1 *Example output of `auditctl -s`*

```
AUDIT_STATUS: enabled=1 flag=2 pid=3105 rate_limit=0 backlog_limit=8192 lost=0
backlog=0
```

Table 30.1 *Audit Status Flags*

Flag	Meaning [Possible Values]	Command
enabled	Set the enable flag. [0..2] 0=disable, 1=enable, 2=enable and lock down the configuration	<code>auditctl -e [0 1]</code>
flag	Set the failure flag. [0..2] 0=silent, 1=printk, 2=panic (immediate halt without syncing pending data to disk)	<code>auditctl -f [0 1 2]</code>

Flag	Meaning [Possible Values]	Command
<code>pid</code>	Process ID under which <code>auditd</code> is running.	—
<code>rate_limit</code>	Set a limit in messages per second. If the rate is not zero and is exceeded, the action specified in the failure flag is triggered.	<code>auditctl -r <i>rate</i></code>
<code>backlog_limit</code>	Specify the maximum number of outstanding audit buffers allowed. If all buffers are full, the action specified in the failure flag is triggered.	<code>auditctl -b <i>backlog</i></code>
<code>lost</code>	Count the current number of lost audit messages.	—
<code>backlog</code>	Count the current number of outstanding audit buffers.	—

30.4 Passing Parameters to the Audit System

Commands to control the audit system can be invoked individually from the shell using `auditctl` or batch read from a file using `auditctl -R`. This latter method is used by the init scripts to load rules from the file `/etc/audit/audit.rules` after the audit daemon has been started. The rules are executed in order from top to bottom. Each of these rules would expand to a separate `auditctl` command. The syntax used in the rules file is the same as that used for the `auditctl` command.

Changes made to the running audit system by executing `auditctl` on the command line are not persistent across system restarts. For changes to persist, add them to the `/etc/audit/audit.rules` file and, if they are not currently loaded into audit, restart the audit system to load the modified rule set by using the `rcauditd restart` command.

Example 30.2 *Example Audit Rules—Audit System Parameters*

```
-b 1000❶  
-f 1❷  
-r 10❸  
-e 1❹
```

- ❶ Specify the maximum number of outstanding audit buffers. Depending on the level of logging activity, you might need to adjust the number of buffers to avoid causing too heavy an audit load on your system.
- ❷ Specify the failure flag to use. See Table 30.1, “Audit Status Flags” (page 390) for possible values.
- ❸ Specify the maximum number of messages per second that may be issued by the kernel. See Table 30.1, “Audit Status Flags” (page 390) for details.
- ❹ Enable or disable the audit subsystem.

Using audit, you can track any kind of file system access to important files, configurations or resources. You can add watches on these and assign keys to each kind of watch for better identification in the logs.

Example 30.3 Example Audit Rules—File System Auditing

```
-w /etc/shadow❶  
-w /etc -p rx❷  
-w /etc/passwd -k fk_passwd -p rwx❸
```

- ❶ The `-w` option tells audit to add a watch to the file specified, in this case `/etc/shadow`. All system calls requesting access permissions to this file are analyzed.
- ❷ This rule adds a watch to the `/etc` directory and applies permission filtering for read and execute access to this directory (`-p wx`). Any system call requesting any of these two permissions is analyzed. Only the creation of new files and the deletion of existing ones are logged as directory-related events. To get more specific events for files located under this particular directory, you should add a separate rule for each file. A file must exist before you add a rule containing a watch on it. Auditing files as they are created is not supported.
- ❸ This rule adds a file watch to `/etc/passwd`. Permission filtering is applied for read, write, execute, and attribute change permissions. The `-k` option allows you to specify a key to use to filter the audit logs for this particular event later (e.g. with `ausearch`). You may use the same key on different rules in order to be able to group rules when searching for them. It is also possible to apply multiple keys to a rule.

System call auditing lets you track your system's behavior on a level even below the application level. When designing these rules, consider that auditing a great many system calls may increase your system load and cause you to run out of disk space. Consider carefully which events need tracking and how they can be filtered to be even more specific.

Example 30.4 Example Audit Rules—System Call Auditing

```
-a entry,always -S mkdir❶  
-a entry,always -S access -F a1=4❷  
-a exit,always -S ipc -F a0=2❸  
-a exit,always -S open -F success!=0❹  
-a task,always -F auid=0❺  
-a task,always -F uid=0 -F auid=501 -F gid=wheel❻
```

- ❶ This rule activates auditing for the `mkdir` system call. The `-a` option adds system call rules. This rule triggers an event whenever the `mkdir` system call is entered (`entry,always`). The `-S` option adds the system call to which this rule should be applied.

- ② This rule adds auditing to the access system call, but only if the second argument of the system call (`mode`) is 4 (`R_OK`). `entry, always` tells audit to add an audit context to this system call when entering it and to write out a report as soon as the call exits.
- ③ This rule adds an audit context to the IPC multiplexed system call. The specific `ipc` system call is passed as the first `syscall` argument and can be selected using `-F a0=ipc_call_number`.
- ④ This rule audits failed attempts to call `open`.
- ⑤ This rule is an example of a task rule (keyword: `task`). It is different from the other rules above in that it applies to processes that are forked or cloned. To filter these kind of events, you can only use fields that are known at fork time, such as `UID`, `GID`, and `AUID`. This example rule filters for all tasks carrying an audit ID of 0.
- ⑥ This last rule makes heavy use of filters. All filter options are combined with a logical AND operator, meaning that this rule applies to all tasks that carry the audit ID of 501, have changed to run as `root`, and have `wheel` as the group. A process is given an audit ID on user login. This ID is then handed down to any child process started by the initial process of the user. Even if the user changes his identity, the audit ID stays the same and allows tracing actions to the original user.

TIP: Filtering System Call Arguments

For more details on filtering system call arguments, refer to Section 32.6, “Filtering System Call Arguments” (page 438).

You can not only add rules to the audit system, but also remove them. Delete rules are used to purge the rule queue of rules that might potentially clash with those you want to add. There are different methods for deleting the entire rule set at once or for deleting system call rules or file and directory watches:

Example 30.5 *Deleting Audit Rules and Events*

```
-D①
-d entry,always -S mkdir②
-w /etc③
```

- ① Clear the queue of audit rules and delete any preexisting rules. This rule is used as the first rule in `/etc/audit/audit.rules` files to make sure that the

rules that are about to be added do not clash with any preexisting ones. The `auditctl -D` command is also used before doing an `autrace` to avoid having the trace rules clash with any rules present in the `audit.rules` file.

- ② This rule deletes a system call rule. The `-d` option must precede any system call rule that needs to be deleted from the rule queue, and must match exactly.
- ③ This rule tells audit to discard the rule with the directory watch on `/etc` from the rules queue. This rule deletes any rule containing a directory watch on `/etc`, regardless of any permission filtering or key options.

To get an overview of which rules are currently in use in your audit setup, run `auditctl -l`. This command displays all rules with one rule per line.

Example 30.6 *Listing Rules with `auditctl -l`*

```
LIST_RULES: exit,always watch=/etc perm=rx
LIST_RULES: exit,always watch=/etc/passwd perm=rwxa key=fk_passwd
LIST_RULES: exit,always watch=/etc/shadow perm=rwxa
LIST_RULES: entry,always syscall=mkdir
LIST_RULES: entry,always a1=4 (0x4) syscall=access
LIST_RULES: exit,always a0=2 (0x2) syscall=ipc
LIST_RULES: exit,always success!=0 syscall=open
```

NOTE: Creating Filter Rules

You can build very sophisticated audit rules by using the various filter options. Refer to the `auditctl(8)` man page for more information about the options available for building audit filter rules, and audit rules in general.

30.5 Understanding the Audit Logs and Generating Reports

To understand what the `aureport` utility does, it is vital to know how the logs generated by the audit daemon are structured, and what exactly is recorded for an event. Only then can you decide which report types are most appropriate for your needs.

30.5.1 Understanding the Audit Logs

The following examples highlight two typical events that are logged by audit and how their trails in the audit log are read. The audit log or logs (if log rotation is enabled) are stored in the `/var/log/audit` directory. The first example is a simple `less` command. The second example covers a great deal of PAM activity in the logs when a user tries to remotely log in to a machine running audit.

Example 30.7 *A Simple Audit Event—Viewing the Audit Log*

```
type=SYSCALL msg=audit(1234874638.599:5207): arch=c000003e syscall=2
success=yes exit=4 a0=62fb60 a1=0 a2=31 a3=0 items=1 ppid=25400 pid
=25616 auid=0 uid=0 gid=0 euid=0 suid=0 fsuid=0 egid=0 sgid=0 fsgid=0 tty=pts1
ses=1164 comm="less" exe="/usr/bin/less" key="doc_log"
type=CWD msg=audit(1234874638.599:5207): cwd="/root"
type=PATH msg=audit(1234874638.599:5207): item=0
name="/var/log/audit/audit.log" inode=1219041 dev=08:06 mode=0100644 ouid=0
ogid=0 rdev=00:00
```

The above event, a simple `less /var/log/audit/audit.log`, wrote three messages to the log. All of them are closely linked together and you would not be able to make sense of one of them without the others. The first message reveals the following information:

`type`

The type of event recorded. In this case, it assigns the `SYSCALL` type to an event triggered by a system call (less or rather the underlying `open`). The `CWD` event was recorded to record the current working directory at the time of the syscall. A `PATH` event is generated for each path passed to the system call. The `open` system call takes only one path argument, so only generates one `PATH` event. It is important to understand that the `PATH` event reports the pathname string argument without any further interpretation, so a relative path requires manual combination with the path reported by the `CWD` event to determine the object accessed.

`msg`

A message ID enclosed in brackets. The ID splits into two parts. All characters before the `:` represent a UNIX epoch time stamp. The number after the colon represents the actual event ID. All events that are logged from one application's system call have the same event ID. If the application makes a second system call, it gets another event ID.

arch

References the CPU architecture of the system call. Decode this information using the `-i` option on any of your `ausearch` commands when searching the logs.

syscall

The type of system call as it would have been printed by an `strace` on this particular system call. This data is taken from the list of system calls under `/usr/include/asm/unistd.h` and may vary depending on the architecture. In this case, `syscall=2` refers to the `open` system call (see `man open(2)`) invoked by the `less` application.

success

Whether the system call succeeded or failed.

exit

The exit value returned by the system call. For the `open` system call used in this example, this is the file descriptor number. This varies by system call.

a0 to a3

The first four arguments to the system call in numeric form. The values of these are totally system call dependent. In this example (an `open` system call), the following are used:

```
a0=62fb60 a1=0 a2=31 a3=0
```

`a0` is the start address of the passed pathname. `a1` is the flags. `8000` in hex notation translates to `100000` in octal notation, which in turn translates to `O_LARGEFILE`. `a2` is the mode, which, because `O_CREAT` was not specified, is unused. `a3` is not passed by the `open` system call. Check the manual page of the relevant system call to find out which arguments are used with it.

items

The number of strings passed to the application.

ppid

The process ID of the parent of the process analyzed.

pid

The process ID of the process analyzed.

`audit`

The audit ID. A process is given an audit ID on user login. This ID is then handed down to any child process started by the initial process of the user. Even if the user changes his identity (for example, becomes `root`), the audit ID stays the same. Thus you can always trace actions to the original user who logged in.

`uid`

The user ID of the user who started the process. In this case, 0 for `root`.

`gid`

The group ID of the user who started the process. In this case, 0 for `root`.

`euid, suid, fsuid`

Effective user ID, set user ID, and file system user ID of the user that started the process.

`egid, sgid, fsgid`

Effective group ID, set group ID, and file system group ID of the user that started the process.

`tty`

The terminal from which the application is started. In this case, a pseudoterminal used in an SSH session.

`ses`

The login session ID. This process attribute is set when a user logs in and can tie any process to a particular user login.

`comm`

The application name under which it appears in the task list.

`exe`

The resolved pathname to the binary program.

`subj`

`auditd` records whether the process is subject to any security context, such as AppArmor. `unconstrained`, as in this case, means that the process is not confined with AppArmor. If the process had been confined, the binary pathname plus the AppArmor profile mode would have been logged.

key

If you are auditing a large number of directories or files, assign key strings each of these watches. You can use these keys with `ausearch` to search the logs for events of this type only.

The second message triggered by the example `less` call does not reveal anything apart from just the current working directory when the `less` command was executed.

The third message reveals the following (the `type` and `message` flags have already been introduced):

item

In this example, `item` references the `a0` argument—a path—that is associated with the original `SYSCALL` message. Had the original call had more than one path argument (such as a `cp` or `mv` command), an additional `PATH` event would have been logged for the second path argument.

name

Refers to the pathname passed as an argument to the `less` (or `open`) call.

inode

Refers to the inode number corresponding to `name`.

dev

Specifies the device on which the file is stored. In this case, `03:01`, which stands for `/dev/sda1` or “first partition on the first IDE device.”

mode

Numerical representation of the file's access permissions. In this case, `root` has read and write permissions and his group (`root`) has read access while the entire rest of the world cannot access the file at all.

ouid and ogid

Refer to the UID and GID of the inode itself.

rdev

Not applicable for this example. The `rdev` entry only applies to block or character devices, not to files.

Example 30.8, “An Advanced Audit Event—Login via SSH” (page 400) highlights the audit events triggered by an incoming SSH connection. Most of the messages are related to the PAM stack and reflect the different stages of the SSH PAM process. Several of the audit messages carry nested PAM messages in them that signify that a particular stage of the PAM process has been reached. Although the PAM messages are logged by audit, audit assigns its own message type to each event:

Example 30.8 *An Advanced Audit Event—Login via SSH*

```
type=USER_AUTH msg=audit(1234877011.791:7731): user pid=26127 uid=0 ❶
aid=4294967295 ses=4294967295 msg='op=PAM:authentication acct="root"
exe="/usr/sbin/sshd"
(hostname=jupiter.example.com, addr=192.168.2.100, terminal=ssh res=success) '
type=USER_ACCT msg=audit(1234877011.795:7732): user pid=26127 uid=0 ❷
aid=4294967295 ses=4294967295 msg='op=PAM:accounting acct="root"
exe="/usr/sbin/sshd"
(hostname=jupiter.example.com, addr=192.168.2.100, terminal=ssh res=success) '
type=CRED_ACQ msg=audit(1234877011.799:7733): user pid=26125 uid=0 ❸
aid=4294967295 ses=4294967295 msg='op=PAM:setcred acct="root"
exe="/usr/sbin/sshd"
(hostname=jupiter.example.com, addr=192.168.2.100, terminal=/dev/pts/0
res=success) '
type=LOGIN msg=audit(1234877011.799:7734): login pid=26125 uid=0
old aid=4294967295 new aid=0 old ses=4294967295 new ses=1172
type=USER_START msg=audit(1234877011.799:7735): user pid=26125 uid=0 ❹
aid=0 ses=1172 msg='op=PAM:session_open acct="root" exe="/usr/sbin/sshd"
(hostname=jupiter.example.com, addr=192.168.2.100, terminal=/dev/pts/0
res=success) '
type=USER_LOGIN msg=audit(1234877011.823:7736): user pid=26128 uid=0 ❺
aid=0 ses=1172 msg='uid=0: exe="/usr/sbin/sshd"
(hostname=jupiter.example.com, addr=192.168.2.100, terminal=/dev/pts/0
res=success) '
type=CRED_REFR msg=audit(1234877011.828:7737): user pid=26128 uid=0 ❻
aid=0 ses=1172 msg='op=PAM:setcred acct="root" exe="/usr/sbin/sshd"
(hostname=jupiter.example.com, addr=192.168.2.100, terminal=/dev/pts/0
res=success) '
```

- ❶ PAM reports that it has successfully requested user authentication for `root` from a remote host (`jupiter.example.com`, `192.168.2.100`). The terminal where this is happening is `ssh`.
- ❷ PAM reports that it has successfully determined whether the user is authorized to log in at all.
- ❸ PAM reports that the appropriate credentials to log in have been acquired and that the terminal changed to a normal terminal (`/dev/pts/0`).

- ⑤ The user has successfully logged in. This event is the one used by `aureport -l` to report about user logins.
- ④ PAM reports that it has successfully opened a session for `root`.
- ⑥ PAM reports that the credentials have been successfully reacquired.

30.5.2 Generating Custom Audit Reports

The raw audit reports stored in the `/var/log/audit` directory tend to become very bulky and hard to understand. To find individual events of interest, you might have to read through thousands of other events before you locate the one that you want. To avoid this, use the `aureport` utility and create custom reports.

The following use cases highlight just a few of the possible report types that you can generate with `aureport`:

Read Audit Logs from Another File

When the audit logs have moved to another machine or when you want to analyze the logs of a number of machines on your local machine without wanting to connect to each of these individually, move the logs to a local file and have `aureport` analyze them locally:

```
aureport -if myfile
```

```
Summary Report
```

```
=====
```

```
Range of time in logs: 03/02/09 14:13:38.225 - 17/02/09 14:52:27.971
```

```
Selected time for report: 03/02/09 14:13:38 - 17/02/09 14:52:27.971
```

```
Number of changes in configuration: 13
```

```
Number of changes to accounts, groups, or roles: 0
```

```
Number of logins: 6
```

```
Number of failed logins: 13
```

```
Number of authentications: 7
```

```
Number of failed authentications: 573
```

```
Number of users: 1
```

```
Number of terminals: 9
```

```
Number of host names: 4
```

```
Number of executables: 17
```

```
Number of files: 279
```

```
Number of AVC's: 0
```

```
Number of MAC events: 0
```

```
Number of failed syscalls: 994
```

```
Number of anomaly events: 0
```

```
Number of responses to anomaly events: 0
```

```
Number of crypto events: 0
```

```
Number of keys: 2
Number of process IDs: 1211
Number of events: 5320
```

The above command, `aureport` without any arguments, provides just the standard general summary report generated from the logs contained in `myfile`. To create more detailed reports, combine the `-if` option with any of the options below. For example, generate a login report that is limited to a certain time frame:

```
aureport -l -ts 14:00 -te 15:00 -if myfile
```

```
Login Report
=====
# date time auid host term exe success event
=====
1. 17/02/09 14:21:09 root: 192.168.2.100 sshd /usr/sbin/sshd no 7718
2. 17/02/09 14:21:15 0 jupiter /dev/pts/3 /usr/sbin/sshd yes 7724
```

Convert Numeric Entities to Text

Some information, such as user IDs, are printed in numeric form. To convert these into a human-readable text format, add the `-i` option to your `aureport` command.

Create a Rough Summary Report

If you are just interested in the current audit statistics (events, logins, processes, etc.), run `aureport` without any other option.

Create a Summary Report of Failed Events

If you want to break down the overall statistics of plain `aureport` to the statistics of failed events, use `aureport --failed`:

```
aureport --failed

Failed Summary Report
=====
Range of time in logs: 03/02/09 14:13:38.225 - 17/02/09 14:57:35.183
Selected time for report: 03/02/09 14:13:38 - 17/02/09 14:57:35.183
Number of changes in configuration: 0
Number of changes to accounts, groups, or roles: 0
Number of logins: 0
Number of failed logins: 13
Number of authentications: 0
Number of failed authentications: 574
Number of users: 1
Number of terminals: 5
Number of host names: 4
Number of executables: 11
Number of files: 77
Number of AVC's: 0
```



```
Number of MAC events: 0
Number of failed syscalls: 994
Number of anomaly events: 0
Number of responses to anomaly events: 0
Number of crypto events: 0
Number of keys: 2
Number of process IDs: 708
Number of events: 1583
```

Create a Summary Report of Successful Events

If you want to break down the overall statistics of a plain `aureport` to the statistics of successful events, use `aureport --success`:

```
aureport --success
```

```
Success Summary Report
=====
Range of time in logs: 03/02/09 14:13:38.225 - 17/02/09 15:00:01.535
Selected time for report: 03/02/09 14:13:38 - 17/02/09 15:00:01.535
Number of changes in configuration: 13
Number of changes to accounts, groups, or roles: 0
Number of logins: 6
Number of failed logins: 0
Number of authentications: 7
Number of failed authentications: 0
Number of users: 1
Number of terminals: 7
Number of host names: 3
Number of executables: 16
Number of files: 215
Number of AVC's: 0
Number of MAC events: 0
Number of failed syscalls: 0
Number of anomaly events: 0
Number of responses to anomaly events: 0
Number of crypto events: 0
Number of keys: 2
Number of process IDs: 558
Number of events: 3739
```

Create Summary Reports

In addition to the dedicated summary reports (main summary and failed and success summary), use the `--summary` option with most of the other options to create summary reports for a particular area of interest only. Not all reports support this option, however. This example creates a summary report for user login events:

```
aureport -u -i --summary
```

```
User Summary Report
=====
total  auid
=====
5640  root
13    tux
3     wilber
```

Create a Report of Events

To get an overview of the events logged by audit, use the `aureport -e` command. This command generates a numbered list of all events including date, time, event number, event type, and audit ID.

```
aureport -e -ts 14:00 -te 14:21
```

```
Event Report
=====
# date time event type auid success
=====
1. 17/02/09 14:20:27 7462 DAEMON_START 0 yes
2. 17/02/09 14:20:27 7715 CONFIG_CHANGE 0 yes
3. 17/02/09 14:20:57 7716 USER_END 0 yes
4. 17/02/09 14:20:57 7717 CRED_DISP 0 yes
5. 17/02/09 14:21:09 7718 USER_LOGIN -1 no
6. 17/02/09 14:21:15 7719 USER_AUTH -1 yes
7. 17/02/09 14:21:15 7720 USER_ACCT -1 yes
8. 17/02/09 14:21:15 7721 CRED_ACQ -1 yes
9. 17/02/09 14:21:15 7722 LOGIN 0 yes
10. 17/02/09 14:21:15 7723 USER_START 0 yes
11. 17/02/09 14:21:15 7724 USER_LOGIN 0 yes
12. 17/02/09 14:21:15 7725 CRED_REFR 0 yes
```

Create a Report from All Process Events

To analyze the log from a process's point of view, use the `aureport -p` command. This command generates a numbered list of all process events including date, time, process ID, name of the executable, system call, audit ID, and event number.

```
aureport -p
```

```
Process ID Report
=====
# date time pid exe syscall auid event
=====
1. 13/02/09 15:30:01 32742 /usr/sbin/cron 0 0 35
2. 13/02/09 15:30:01 32742 /usr/sbin/cron 0 0 36
3. 13/02/09 15:38:34 32734 /usr/lib/gdm/gdm-session-worker 0 -1 37
```

Create a Report from All System Call Events

To analyze the audit log from a system call's point of view, use the `aureport -s` command. This command generates a numbered list of all system call events including date, time, number of the system call, process ID, name of the command that used this call, audit ID, and event number.

```
aureport -s

Syscall Report
=====
# date time syscall pid comm audit event
=====
1. 16/02/09 17:45:01 2 20343 cron -1 2279
2. 16/02/09 17:45:02 83 20350 mktemp 0 2284
3. 16/02/09 17:45:02 83 20351 mkdir 0 2285
```

Create a Report from All Executable Events

To analyze the audit log from an executable's point of view, use the `aureport -x` command. This command generates a numbered list of all executable events including date, time, name of the executable, the terminal it is run in, the host executing it, the audit ID, and event number.

```
aureport -x

Executable Report
=====
# date time exe term host audit event
=====
1. 13/02/09 15:08:26 /usr/sbin/sshd sshd 192.168.2.100 -1 12
2. 13/02/09 15:08:28 /usr/lib/gdm/gdm-session-worker :0 ? -1 13
3. 13/02/09 15:08:28 /usr/sbin/sshd ssh 192.168.2.100 -1 14
```

Create a Report about Files

To generate a report from the audit log that focuses on file access, use the `aureport -f` command. This command generates a numbered list of all file-related events including date, time, name of the accessed file, number of the system call accessing it, success or failure of the command, the executable accessing the file, audit ID, and event number.

```
aureport -f

File Report
=====
# date time file syscall success exe audit event
=====
1. 16/02/09 17:45:01 /etc/shadow 2 yes /usr/sbin/cron -1 2279
2. 16/02/09 17:45:02 /tmp/ 83 yes /bin/mktemp 0 2284
3. 16/02/09 17:45:02 /var 83 no /bin/mkdir 0 2285
```

Create a Report about Users

To generate a report from the audit log that illustrates which users are running what executables on your system, use the `aureport -u` command. This command generates a numbered list of all user-related events including date, time, audit ID, terminal used, host, name of the executable, and an event ID.

```
aureport -u

User ID Report
=====
# date time auid term host exe event
=====
1. 13/02/09 15:08:26 -1 sshd 192.168.2.100 /usr/sbin/sshd 12
2. 13/02/09 15:08:28 -1 :0 ? /usr/lib/gdm/gdm-session-worker 13
3. 14/02/09 08:25:39 -1 ssh 192.168.2.101 /usr/sbin/sshd 14
```

Create a Report about Logins

To create a report that focuses on login attempts to your machine, run the `aureport -l` command. This command generates a numbered list of all login-related events including date, time, audit ID, host and terminal used, name of the executable, success or failure of the attempt, and an event ID.

```
aureport -l -i

Login Report
=====
# date time auid host term exe success event
=====
1. 13/02/09 15:08:31 tux: 192.168.2.100 sshd /usr/sbin/sshd no 19
2. 16/02/09 12:39:05 root: 192.168.2.101 sshd /usr/sbin/sshd no 2108
3. 17/02/09 15:29:07 geeko: ? tty3 /bin/login yes 7809
```

Limit a Report to a Certain Time Frame

To analyze the logs for a particular time frame, such as only the working hours of Feb 16, 2009, first find out whether this data is contained in the the current `audit.log` or whether the logs have been rotated in by running `aureport -t`:

```
aureport -t

Log Time Range Report
=====
/var/log/audit/audit.log: 03/02/09 14:13:38.225 - 17/02/09 15:30:01.636
```

The current `audit.log` contains all the desired data. Otherwise, use the `-if` option to point the `aureport` commands to the log file that contains the needed data.

Then, specify the start date and time and the end date and time of the desired time frame and combine it with the report option needed. This example focuses on login attempts:

```
aureport -ts 02/16/09 8:00 -te 02/16/09 18:00 -l

Login Report
=====
# date time auid host term exe success event
=====
1. 16/02/09 12:39:05 root: 192.168.2.100 sshd /usr/sbin/sshd no 2108
2. 16/02/09 12:39:12 0 192.168.2.100 /dev/pts/1 /usr/sbin/sshd yes 2114
3. 16/02/09 13:09:28 root: 192.168.2.100 sshd /usr/sbin/sshd no 2131
4. 16/02/09 13:09:32 root: 192.168.2.100 sshd /usr/sbin/sshd no 2133
5. 16/02/09 13:09:37 0 192.168.2.100 /dev/pts/2 /usr/sbin/sshd yes 2139
```

The start date and time are specified with the `-ts` option. Any event that has a time stamp equal to or after your given start time appears in the report. If you omit the date, `aureport` assumes that you meant *today*. If you omit the time, it assumes that the start time should be midnight of the date specified. Use the 24 clock notation rather than the 12 hour one and adjust the date format to your locale (specified in `/etc/sysconfig/audit` under `AUDITD_LANG`, default is `en_US`).

Specify the end date and time with the `-te` option. Any event that has a time stamp equal to or before your given event time appears in the report. If you omit the date, `aureport` assumes that you meant today. If you omit the time, it assumes that the end time should be now. Use a similar format for the date and time as for `-ts`.

All reports except the summary ones are printed in column format and sent to `STDOUT`, which means that this data can be piped to other commands very easily. The visualization scripts introduced in Section 30.8, “Visualizing Audit Data” (page 412) are just one example of how to further process the data generated by audit.

30.6 Querying the Audit Daemon Logs with ausearch

The `aureport` tool helps you to create overall summaries of what is happening on the system, but if you are interested in the details of a particular event, `ausearch` is the tool to use. `ausearch` allows you to search the audit logs using special keys and search phrases that relate to most of the flags that appear in event messages in `/var/log/`

`audit/audit.log`. Not all record types contain the same search phrases. There are no `hostname` or `uid` entries in a `PATH` record, for example. When searching, make sure that you choose appropriate search criteria to catch all records you need. On the other hand, you could be searching for a specific type of record and still get various other related records along with it. This is caused by different parts of the kernel contributing additional records for events that are related to the one to find. For example, you would always get a `PATH` record along with the `SYSCALL` record for an `open` system call.

TIP: Using Multiple Search Options

Any of the command line options can be combined with logical AND operators to narrow down your search.

Read Audit Logs from Another File

When the audit logs have moved to another machine or when you want to analyze the logs of a number of machines on your local machine without wanting to connect to each of these individually, move the logs to a local file and have `ausearch` search them locally:

```
ausearch -option -if myfile
```

Convert Numeric Results into Text

Some information, such as user IDs are printed in numeric form. To convert these into human readable text format, add the `-i` option to your `ausearch` command.

Search by Audit Event ID

If you have previously run an audit report or done an `autrace`, you might want to analyze the trail of a particular event in the log. Most of the report types described in Section 30.5, “Understanding the Audit Logs and Generating Reports” (page 395) include audit event IDs in their output. An audit event ID is the second part of an audit message ID, which consists of a UNIX epoch time stamp and the audit event ID separated by a colon. All events that are logged from one application's system call have the same event ID. Use this event ID with `ausearch` to retrieve this event's trail from the log.

The `autrace` tool asks you to review the complete trail of the command traced in the logs using `ausearch`. `autrace` provides you with the complete `ausearch` command including the audit event ID.

In both cases, use a command similar to the following:

```
ausearch -a 5207
----
time->Tue Feb 17 13:43:58 2009
type=PATH msg=audit(1234874638.599:5207): item=0
name="/var/log/audit/audit.log" inode=1219041 dev=08:06 mode=0100644 ouid=0
ogid=0 rdev=00:00
type=CWD msg=audit(1234874638.599:5207): cwd="/root"
type=SYSCALL msg=audit(1234874638.599:5207): arch=c000003e syscall=2
success=yes exit=4 a0=62fb60 a1=0 a2=31 a3=0 items=1 ppid=25400 pid=25616
aid=0 uid=0 gid=0 euid=0 suid=0 fsuid=0 egid=0 sgid=0 fsgid=0 tty=pts1
ses=1164 comm="less" exe="/usr/bin/less" key="doc_log"
```

The `ausearch -a` command grabs all records in the logs that are related to the audit event ID provided and displays them. This option cannot be combined with any other option.

Search by Message Type

To search for audit records of a particular message type, use the `ausearch -m message_type` command. Examples of valid message types include `PATH`, `SYSCALL`, and `USER_LOGIN`. Running `ausearch -m` without a message type displays a list of all message types.

Search by Login ID

To view records associated with a particular login user ID, use the `ausearch -ul` command. It displays any records related to the user login ID specified provided that user had been able to log in successfully.

Search by User ID

View records related to any of the user IDs (both user ID and effective user ID) with `ausearch -ua`. View reports related to a particular user ID with `ausearch -ui uid`. Search for records related to a particular effective user ID, use the `ausearch -ue euid`. Searching for a user ID means the user ID of the user creating a process. Searching for an effective user ID means the user ID and privileges that are required to run this process.

Search by Group ID

View records related to any of the group IDs (both group ID and effective group ID) with the `ausearch -ga` command. View reports related to a particular user ID with `ausearch -gi gid`. Search for records related to a particular effective group ID, use `ausearch -ge egid`.

Search by Command Line Name

View records related to a certain command, using the `ausearch -c comm_name` command, for example, `ausearch -c less` for all records related to the `less` command.

Search by Executable Name

View records related to a certain executable with the `ausearch -x exe command`, for example `ausearch -x /usr/bin/less` for all records related to the `/usr/bin/less` executable.

Search by System Call Name

View records related to a certain system call with the `ausearch -sc syscall` command, for example, `ausearch -sc open` for all records related to the `open` system call.

Search by Process ID

View records related to a certain process ID with the `ausearch -p pid` command, for example `ausearch -p 13368` for all records related to this process ID.

Search by Event or System Call Success Value

View records containing a certain system call success value with `ausearch -sv success_value`, for example, `ausearch -sv yes` for all successful system calls.

Search by Filename

View records containing a certain filename with `ausearch -f filename`, for example, `ausearch -f /foo/bar` for all records related to the `/foo/bar` file. Using the filename alone would work as well, but using relative paths would not.

Search by Terminal

View records of events related to a certain terminal only with `ausearch -tm term`, for example, `ausearch -tm ssh` to view all records related to events on the SSH terminal and `ausearch -tm tty` to view all events related to the console.

Search by Hostname

View records related to a certain remote hostname with `ausearch -hn hostname`, for example, `ausearch -hn jupiter.example.com`. You can use a hostname, fully qualified domain name, or numeric network address.

Search by Key Field

View records that contain a certain key assigned in the audit rule set to identify events of a particular type. Use the `ausearch -k key_field`, for example, `ausearch -k CFG_etc` to display any records containing the `CFG_etc` key.

Search by Word

View records that contain a certain string assigned in the audit rule set to identify events of a particular type. The whole string will be matched on filename, hostname, and terminal. Use the `ausearch -w word`.

Limit a Search to a Certain Time Frame

Use `-ts` and `-te` to limit the scope of your searches to a certain time frame. The `-ts` option is used to specify the start date and time and the `-te` option is used to specify the end date and time. These options can be combined with any of the above, except the `-a` option. The use of these options is similar to use with `aureport`.

30.7 Analyzing Processes with `autrace`

In addition to monitoring your system using the rules you set up, you can also perform dedicated audits of individual processes using the `autrace` command. `autrace` works similarly to the `strace` command, but gathers slightly different information. The output of `autrace` is written to `/var/log/audit/audit.log` and does not look any different from the standard audit log entries.

When performing an `autrace` on a process, make sure that any audit rules are purged from the queue to avoid these rules clashing with the ones `autrace` adds itself. Delete the audit rules with the `auditctl -D` command. This stops all normal auditing.

```

auditctl -D

No rules

autrace /usr/bin/less /etc/sysconfig/auditd

Waiting to execute: /usr/bin/less
Cleaning up...
No rules
Trace complete. You can locate the records with 'ausearch -i -p 7642'

```

Always use the full path to the executable to track with `autrace`. After the trace is complete, `autrace` provides the event ID of the trace, so you can analyze the entire data trail with `ausearch`. To restore the audit system to use the audit rule set again, just restart the audit daemon with `rcauditd restart`.

30.8 Visualizing Audit Data

Neither the data trail in `/var/log/audit/audit.log` nor the different report types generated by `aureport`, described in Section 30.5.2, “Generating Custom Audit Reports” (page 401), provide an intuitive reading experience to the user. The `aureport` output is formatted in columns and thus easily available to any `sed`, `perl`, or `awk` scripts that users might connect to the audit framework to visualize the audit data.

The visualization scripts (see Section 31.6, “Configuring Log Visualization” (page 428)) are one example of how to use standard Linux tools available with SUSE Linux Enterprise Server or any other Linux distribution to create easy-to-read audit output. The following examples help you understand how the plain audit reports can be transformed into human readable graphics.

The first example illustrates the relationship of programs and system calls. To get to this kind of data, you need to determine the appropriate `aureport` command that delivers the source data from which to generate the final graphic:

```

aureport -s -i

Syscall Report
=====
# date time syscall pid comm auid event
=====
1. 16/02/09 17:45:01 open 20343 cron unset 2279
2. 16/02/09 17:45:02 mkdir 20350 mktemp root 2284

```

```
3. 16/02/09 17:45:02 mkdir 20351 mkdir root 2285
...
```

The first thing that the visualization script needs to do on this report is to extract only those columns that are of interest, in this example, the `syscall` and the `comm` columns. The output is sorted and duplicates removed then the final output is piped into the visualization program itself:

```
LC_ALL=C aureport -s -i | awk '/^[0-9]/ { print $6" "$4 }' | sort | uniq |
mkgraph
```

NOTE: Adjusting the Locale

Depending on your choice of locale in `/etc/sysconfig/auditd`, your `aureport` output might contain an additional data column for AM/PM on time stamps. To avoid having this confuse your scripts, precede your script calls with `LC_ALL=C` to reset the locale and use the 24 hour time format.

Figure 30.2 *Flow Graph—Program versus System Call Relationship*

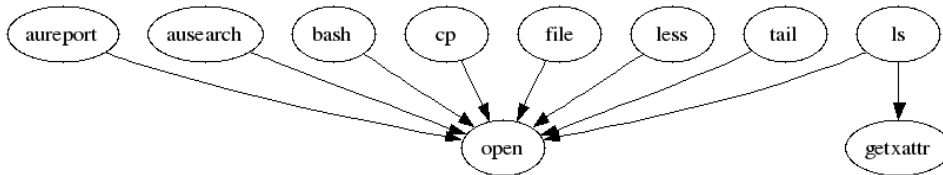

The second example illustrates the different types of events and how many of each type have been logged. The appropriate `aureport` command to extract this kind of information is `aureport -e`:

```
aureport -e -i --summary
```

```
Event Summary Report
=====
total  type
=====
2434  SYSCALL
816   USER_START
816   USER_ACCT
814   CRED_ACQ
810   LOGIN
806   CRED_DISP
779   USER_END
99    CONFIG_CHANGE
52    USER_LOGIN
```

Because this type of report already contains a two column output, it is just fed into the the visualization script and transformed into a bar chart.

```
aureport -e -i --summary | mkbar events
```

Figure 30.3 Bar Chart—Common Event Types

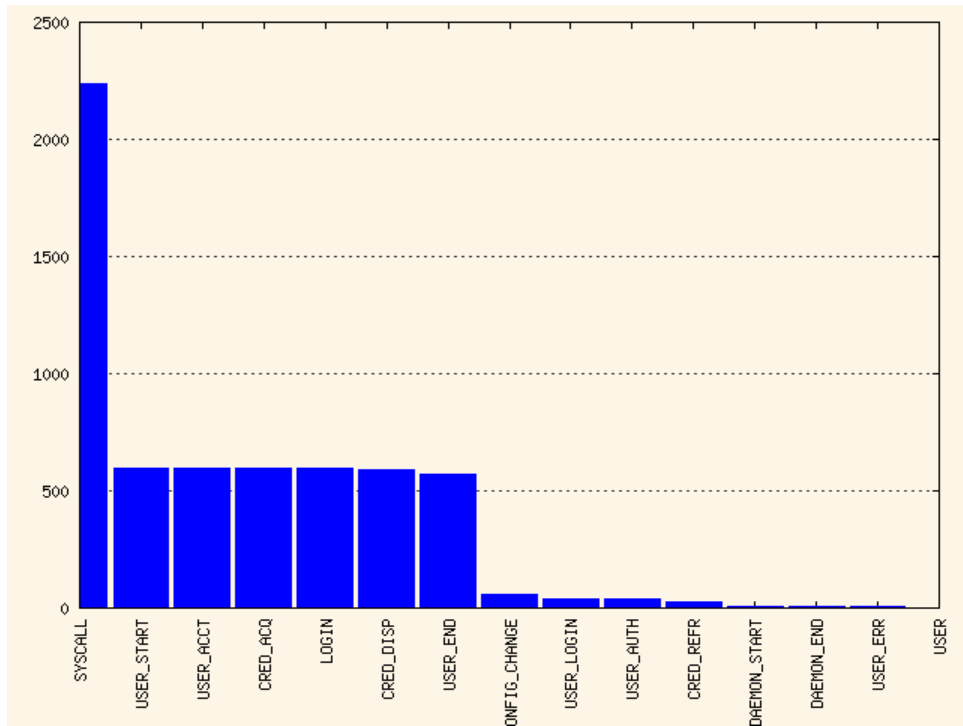

For background information about the visualization of audit data, refer to the Web site of the audit project at <http://people.redhat.com/sgrubb/audit/visualize/index.html>.

30.9 Relaying Audit Event Notifications

The auditing system also allows external applications to access and make use of the auditd daemon in real time. This feature is provided by so called *audit dispatcher* which

allows, for example, intrusion detection systems to use the auditd daemon to receive enhanced detection information.

audispd is a daemon which controls the audit dispatcher. It is normally started by the auditd daemon. The audispd daemon takes audit events and distributes them to the programs which want to analyze them in real time. Configuration of the auditd daemon is stored in `/etc/audisp/audispd.conf`. The file has the following options:

`q_depth`

Specifies the size of the event dispatcher internal queue. If syslog complains about audit events getting dropped, increase this value. Default is 80.

`overflow_action`

Specifies the way the audit daemon will react to the internal queue overflow. Possible values are `ignore` (nothing happens), `syslog` (issues a warning to syslog), `suspend` (audispd will stop processing events), `single` (the computer system will be put in single user mode), or `halt` (shuts the system down).

`priority_boost`

Specifies the priority for the audit event dispatcher (in addition to the audit daemon priority itself). Default is 4 which means no change in priority.

`name_format`

Specifies the way the computer node name is inserted into the audit event. Possible values are `none` (no computer name is inserted), `hostname` (name returned by the `gethostname` system call), `fqdn` (fully qualified domain name of the machine), `numeric` (IP address of the machine), or `user` (user defined string from the `name` option). Default is `none`.

`name`

Specifies a user defined string which identifies the machine. The `name_format` option must be set to `user`, otherwise this option is ignored.

Example 30.9 *Example `/etc/audisp/audispd.conf`*

```
q_depth = 80
overflow_action = SYSLOG
priority_boost = 4
name_format = HOSTNAME
#name = mydomain
```

The plugin programs install their configuration files in a special directory dedicated to `audispd` plugins. It is `/etc/audisp/plugins.d` by default. The plugin configuration files have the following options:

`active`

Specifies if the program will make use of `audispd`. Possible values are `yes` or `no`.

`direction`

Specifies the way the plugin was designed to communicate with audit. It informs the event dispatcher in which directions the events flow. Possible values are `in` or `out`.

`path`

Specifies the absolute path to the plugin executable. In case of internal plugins, this option specifies the plugin name.

`type`

Specifies the way the plugin is to be run. Possible values are `builtin` or `always`. Use `builtin` for internal plugins (`af_unix` and `syslog`) and `always` for most (if not all) other plugins. Default is `always`.

`args`

Specifies the argument that is passed to the plugin program. Normally, plugin programs read their arguments from their configuration file and do not need to receive any arguments. There is a limit of 2 arguments.

`format`

Specifies the format of data that the audit dispatcher passes to the plugin program. Valid options are `binary` or `string`. `binary` passes the data exactly as the event dispatcher receives them from the audit daemon. `string` instructs the dispatcher to change the event into a string that is parsable by the audit parsing library. Default is `string`.

Example 30.10 *Example /etc/audit/plugins.d/syslog.conf*

```
active = no
direction = out
path = builtin_syslog
type = builtin
args = LOG_INFO
format = string
```

Setting Up the Linux Audit Framework

31

This chapter shows how to set up a simple audit scenario. Every step involved in configuring and enabling audit is explained in detail. After you have learned to set up audit, consider a real-world example scenario in Chapter 32, *Introducing an Audit Rule Set* (page 431).

To set up audit on SUSE Linux Enterprise Server, you need to complete the following steps:

Procedure 31.1 *Setting Up the Linux Audit Framework*

- 1** Make sure that all required packages are installed: `audit`, `audit-libs`, and optionally `audit-libs-python`. To use the log visualization as described in Section 31.6, “Configuring Log Visualization” (page 428), install `gnuplot` and `graphviz` from the SUSE Linux Enterprise Server media.
- 2** Determine the components to audit. Refer to Section 31.1, “Determining the Components to Audit” (page 420) for details.
- 3** Check or modify the basic audit daemon configuration. Refer to Section 31.2, “Configuring the Audit Daemon” (page 421) for details.
- 4** Enable auditing for system calls. Refer to Section 31.3, “Enabling Audit for System Calls” (page 422) for details.
- 5** Compose audit rules to suit your scenario. Refer to Section 31.4, “Setting Up Audit Rules” (page 423) for details.

- 6 Generate logs and configure tailor-made reports. Refer to Section 31.5, “Configuring Audit Reports” (page 425) for details.
- 7 Configure optional log visualization. Refer to Section 31.6, “Configuring Log Visualization” (page 428) for details.

IMPORTANT: Controlling the Audit Daemon

Before configuring any of the components of the audit system, make sure that the audit daemon is not running by entering `rcauditd status` as `root`. On a default SUSE Linux Enterprise Server system, audit is started on boot, so you need to turn it off by entering `rcauditd stop`. Start the daemon after configuring it with `rcauditd start`.

31.1 Determining the Components to Audit

Before starting to create your own audit configuration, determine to which degree you want to use it. Check the following general rules to determine which use case best applies to you and your requirements:

- If you require a full security audit for CAPP/EAL certification, enable full audit for system calls and configure watches on various configuration files and directories, similar to the rule set featured in Chapter 32, *Introducing an Audit Rule Set* (page 431). Proceed to Section 31.3, “Enabling Audit for System Calls” (page 422).
- If you require an occasional audit of a system call instead of a permanent audit for system calls, use `autrace`. Proceed to Section 31.3, “Enabling Audit for System Calls” (page 422).
- If you require file and directory watches to track access to important or security-sensitive data, create a rule set matching these requirements. Enable audit as described in Section 31.3, “Enabling Audit for System Calls” (page 422) and proceed to Section 31.4, “Setting Up Audit Rules” (page 423).

31.2 Configuring the Audit Daemon

The basic setup of the audit daemon is done by editing `/etc/audit/auditd.conf`. You may also use YaST to configure the basic settings by calling `YaST > Security and Users > Linux Audit Framework (LAF)`. Use the tabs *Log File* and *Disk Space* for configuration.

```
log_file = /var/log/audit/audit.log
log_format = RAW
log_group = root
priority_boost = 4
flush = INCREMENTAL
freq = 20
num_logs = 4
disp_qos = lossy
dispatcher = /sbin/audispd
name_format = NONE
#name = mydomain
max_log_file = 5
max_log_file_action = ROTATE
space_left = 75
space_left_action = SYSLOG
action_mail_acct = root
admin_space_left = 50
admin_space_left_action = SUSPEND
disk_full_action = SUSPEND
disk_error_action = SUSPEND
#tcp_listen_port =
tcp_listen_queue = 5
#tcp_client_ports = 1024-65535
tcp_client_max_idle = 0
```

The default settings work reasonably well for many setups. Some values, such as `num_logs`, `max_log_file`, `space_left`, and `admin_space_left` depend on the size of your deployment. If disk space is limited, you might want to reduce the number of log files to keep if they are rotated and you might want get an earlier warning if disk space is running out. For a CAPP-compliant setup, adjust the values for `log_file`, `flush`, `max_log_file`, `max_log_file_action`, `space_left`, `space_left_action`, `admin_space_left`, `admin_space_left_action`, `disk_full_action`, and `disk_error_action`, as described in Section 30.2, “Configuring the Audit Daemon” (page 384). An example CAPP-compliant configuration looks like this:

```
log_file = path_to_separate_partition/audit.log
log_format = RAW
priority_boost = 4
flush = SYNC                                ### or DATA
freq = 20
num_logs = 4
dispatcher = /sbin/audispd
disp_qos = lossy
max_log_file = 5
max_log_file_action = KEEP_LOGS
space_left = 75
space_left_action = EMAIL
action_mail_acct = root
admin_space_left = 50
admin_space_left_action = SINGLE           ### or HALT
disk_full_action = SUSPEND                 ### or HALT
disk_error_action = SUSPEND                ### or HALT
```

The ### precedes comments where you can choose from several options. Do not add the comments to your actual configuration files.

TIP: For More Information

Refer to Section 30.2, “Configuring the Audit Daemon” (page 384) for detailed background information about the `auditd.conf` configuration parameters.

31.3 Enabling Audit for System Calls

A standard SUSE Linux Enterprise Server system has `auditd` running by default. There are different levels of auditing activity available:

Basic Logging

Out of the box (without any further configuration) `auditd` logs only events concerning its own configuration changes to `/var/log/audit/audit.log`. No events (file access, system call, etc.) are generated by the kernel audit component until requested by `auditctl`. However, other kernel components and modules may log audit events outside of the control of `auditctl` and these appear in the audit log. By default, the only module that generates audit events is Novell AppArmor.

Advanced Logging with System Call Auditing

To audit system calls and get meaningful file watches, you need to enable audit contexts for system calls.

As you need system call auditing capabilities even when you are configuring plain file or directory watches, you need to enable audit contexts for system calls. To enable audit contexts for the duration of the current session only, execute `auditctl -e 1` as `root`. To disable this feature, execute `auditctl -e 0` as `root`.

To enable audit contexts for system calls permanently, open the `/etc/sysconfig/auditd` configuration file as `root` and set `AUDITD_DISABLE_CONTEXTS` to `no`. Then restart the audit daemon with the `rcauditd restart` command. To turn this feature off temporarily, use `auditctl -e 0`. To turn it off permanently, set `AUDITD_DISABLE_CONTEXTS` to `yes`.

31.4 Setting Up Audit Rules

Using audit rules, determine which aspects of the system should be analyzed by audit. Normally this includes important databases and security-relevant configuration files. You may also analyze various system calls in detail if a broad analysis of your system is required. A very detailed example configuration that includes most of the rules that are needed in a CAPP compliant environment is available in Chapter 32, *Introducing an Audit Rule Set* (page 431).

Audit rules can be passed to the audit daemon on the `auditctl` command line as well as by composing a rule set in `/etc/audit/audit.rules` which is processed whenever the audit daemon is started. To customize `/etc/audit/audit.rules` either edit it directly, or use YaST: *Security and Users > Linux Audit Framework (LAF) > Rules for 'auditctl'*. Rules passed on the commandline are not persistent and have to be re-entered when the audit daemon is restarted.

A simple rule set for very basic auditing on a few important files and directories could look like this:

```
# basic audit system parameters
-D
-b 8192
-f 1
-e 1

# some file and directory watches with keys
-w /var/log/audit/ -k LOG_audit
-w /etc/audit/auditd.conf -k CFG_audit_conf -p rxwa
-w /etc/audit.rules -k CFG_audit_rules -p rxwa
```

```
-w /etc/passwd -k CFG_passwd -p rwx  
-w /etc/sysconfig/ -k CFG_sysconfig  
  
# an example system call rule  
-a entry,always -S umask  
  
### add your own rules
```

When configuring the basic audit system parameters (such as the backlog parameter `-b`) test these settings with your intended audit rule set to determine whether the backlog size is appropriate for the level of logging activity caused by your audit rule set. If your chosen backlog size is too small, your system might not be able to handle the audit load and consult the failure flag (`-f`) when the backlog limit is exceeded.

IMPORTANT: Choosing the Failure Flag

When choosing the failure flag, note that `-f 2` tells your system to perform an immediate shutdown without flushing any pending data to disk when the limits of your audit system are exceeded. Because this shutdown is not a clean shutdown, restrict the use of `-f 2` to only the most security-conscious environments and use `-f 1` (system continues to run, issues a warning and audit stops) for any other setup to avoid loss of data or data corruption.

Directory watches produce less verbose output than separate file watches for the files under these directories. To get detailed logging for your system configuration in `/etc/sysconfig`, for example, add watches for each individual file. Audit does not support globbing, which means you cannot just create a rule that says `-w /etc/*` and watches anything below `/etc`.

For better identification in the log file, a key has been added to each of the file and directory watches. Using the key, it is easier to comb the logs for events related to a certain rule. When creating keys, distinguish between mere log file watches and configuration file watches by using an appropriate prefix with the key, in this case `LOG` for a log file watch and `CFG` for a configuration file watch. Using the filename as part of the key also makes it easier for you to identify events of this type in the log file.

Another thing to bear in mind when creating file and directory watches is that audit cannot deal with files that do not exist when the rules are created. Any file that is added to your system while audit is already running is not watched unless you extend the rule set to watch this new file.

For more information about creating custom rules, refer to Section 30.4, “Passing Parameters to the Audit System” (page 391).

IMPORTANT: Changing Audit Rules

Never change audit rules in a running audit system. Always stop the audit daemon with `rcauditd stop` before touching the audit configuration and reread the audit configuration by restarting the daemon with `rcauditd start`.

31.5 Configuring Audit Reports

To avoid having to dig through the raw audit logs to get an impression of what your system is currently doing, run custom audit reports at certain intervals. Custom audit reports enable you to focus on areas of interest and get meaningful statistics on the nature and frequency of the events you are monitoring. To analyze individual events in detail, use the `ausearch` tool.

Before setting up audit reporting, consider the following:

- What types of events do you want to monitor by generating regular reports? Select the appropriate `aureport` command lines as described in Section 30.5.2, “Generating Custom Audit Reports” (page 401).
- What do you want to do with the audit reports? Decide whether to create graphical charts from the data accumulated or whether it should be transferred into any sort of spreadsheet or database. Set up the `aureport` command line and further processing similar to the examples shown in Section 31.6, “Configuring Log Visualization” (page 428) if you want to visualize your reports.
- When and at which intervals should the reports run? Set up appropriate automated reporting using `cron`.

For this example, assume that you are interested in finding out about any attempts to access your audit, PAM, and system configuration. Proceed as follows to find out about file events on your system:

- 1 Generate a full summary report of all events and check for any anomalies in the summary report, for example, have a look at the “failed syscalls” record, because

these might have failed due to insufficient permissions to access a file or a file not being there at all:

```
aureport
```

```
Summary Report
```

```
=====
```

```
Range of time in logs: 03/02/09 14:13:38.225 - 17/02/09 16:30:10.352
Selected time for report: 03/02/09 14:13:38 - 17/02/09 16:30:10.352
Number of changes in configuration: 24
Number of changes to accounts, groups, or roles: 0
Number of logins: 9
Number of failed logins: 15
Number of authentications: 19
Number of failed authentications: 578
Number of users: 3
Number of terminals: 15
Number of host names: 4
Number of executables: 20
Number of files: 279
Number of AVC's: 0
Number of MAC events: 0
Number of failed syscalls: 994
Number of anomaly events: 0
Number of responses to anomaly events: 0
Number of crypto events: 0
Number of keys: 2
Number of process IDs: 1238
Number of events: 5435
```

2 Run a summary report for failed events and check the “files” record for the number of failed file access events:

```
aureport --failed
```

```
Failed Summary Report
```

```
=====
```

```
Range of time in logs: 03/02/09 14:13:38.225 - 17/02/09 16:30:10.352
Selected time for report: 03/02/09 14:13:38 - 17/02/09 16:30:10.352
Number of changes in configuration: 0
Number of changes to accounts, groups, or roles: 0
Number of logins: 0
Number of failed logins: 15
Number of authentications: 0
Number of failed authentications: 578
Number of users: 1
Number of terminals: 7
Number of host names: 4
Number of executables: 12
Number of files: 77
Number of AVC's: 0
```



```
Number of MAC events: 0
Number of failed syscalls: 994
Number of anomaly events: 0
Number of responses to anomaly events: 0
Number of crypto events: 0
Number of keys: 2
Number of process IDs: 713
Number of events: 1589
```

3 To list the files that could not be accessed, run a summary report of failed file events:

```
aureport -f -i --failed --summary

Failed File Summary Report
=====
total file
=====
80 /var
80 spool
80 cron
80 lastrun
46 /usr/lib/locale/en_GB.UTF-8/LC_CTYPE
45 /usr/lib/locale/locale-archive
38 /usr/lib/locale/en_GB.UTF-8/LC_IDENTIFICATION
38 /usr/lib/locale/en_GB.UTF-8/LC_MEASUREMENT
38 /usr/lib/locale/en_GB.UTF-8/LC_TELEPHONE
38 /usr/lib/locale/en_GB.UTF-8/LC_ADDRESS
38 /usr/lib/locale/en_GB.UTF-8/LC_NAME
38 /usr/lib/locale/en_GB.UTF-8/LC_PAPER
38 /usr/lib/locale/en_GB.UTF-8/LC_MESSAGES
38 /usr/lib/locale/en_GB.UTF-8/LC_MONETARY
38 /usr/lib/locale/en_GB.UTF-8/LC_COLLATE
38 /usr/lib/locale/en_GB.UTF-8/LC_TIME
38 /usr/lib/locale/en_GB.UTF-8/LC_NUMERIC
8 /etc/magic.mgc
...
```

To focus this summary report on a few files or directories of interest only, such as `/etc/audit/auditd.conf`, `/etc/pam.d`, and `/etc/sysconfig`, use a command similar to the following:

```
aureport -f -i --failed --summary |grep -e "/etc/audit/auditd.conf" -e
"/etc/pam.d/" -e "/etc/sysconfig"

1 /etc/sysconfig/displaymanager
```

4 From the summary report, then proceed to isolate these items of interest from the log and find out their event IDs for further analysis:

```
aureport -f -i --failed |grep -e "/etc/audit/auditd.conf" -e
"/etc/pam.d/" -e "/etc/sysconfig"

993. 17/02/09 16:47:34 /etc/sysconfig/displaymanager readlink no
/bin/vim-normal root 7887
994. 17/02/09 16:48:23 /etc/sysconfig/displaymanager getxattr no
/bin/vim-normal root 7889
```

5 Use the event ID to get a detailed record for each item of interest:

```
ausearch -a 7887 -i
-----
time->Tue Feb 17 16:48:23 2009
type=PATH msg=audit(1234885703.090:7889): item=0
name="/etc/sysconfig/displaymanager" inode=369282 dev=08:06 mode=0100644
  ound=0 ogid=0 rdev=00:00
type=CWD msg=audit(1234885703.090:7889): cwd="/root"
type=SYSCALL msg=audit(1234885703.090:7889): arch=c000003e syscall=191
  success=no exit=-61 a0=7e1e20 a1=7f90e4cf9187 a2=7fffd5b57d0 a3=84
  items=1 ppid=25548 pid=23045 auid=0 uid=0 gid=0 euid=0 suid=0 fsuid=0
  egid=0 sgid=0 fsgid=0 tty=pts2 ses=1166 comm="vim" exe="/bin/vim-normal"
  key=(null)
```

TIP: Focusing on a Certain Time Frame

If you are interested in events during a particular period of time, trim down the reports by using start and end dates and times with your `aureport` commands (`-ts` and `-te`). For more information, refer to Section 30.5.2, “Generating Custom Audit Reports” (page 401).

All steps (except for the last one) can be run automatically and would easily be scriptable and configured as cron jobs. Any of the `--failed` `--summary` reports could be transformed easily into a bar chart that plots files versus failed access attempts. For more information about visualizing audit report data, refer to Section 31.6, “Configuring Log Visualization” (page 428).

31.6 Configuring Log Visualization

Using the scripts `mkbar` and `mkgraph` you can illustrate your audit statistics with various graphs and charts. As with any other `aureport` command, the plotting commands are scriptable and can easily be configured to run as cron jobs.

`mkbar` and `mkgraph` were created by Steve Grubb at Red Hat. They are available from <http://people.redhat.com/sgrubb/audit/visualize/>. Because the current version of audit in SUSE Linux Enterprise Server does not ship with these scripts, proceed as follows to make them available on your system:

1 Download the scripts to `root`'s `~/bin` directory:

```
wget http://people.redhat.com/sgrubb/audit/visualize/mkbar -O ~/bin/mkbar
wget http://people.redhat.com/sgrubb/audit/visualize/mkgraph -O
~/bin/mkgraph
```

2 Adjust the file permissions to read, write, and execute for `root`:

```
chmod 744 ~/bin/mk{bar,graph}
```

To plot summary reports, such as the ones discussed in Section 31.5, “Configuring Audit Reports” (page 425), use the script `mkbar`. Some example commands could look like the following:

Create a Summary of Events

```
aureport -e -i --summary | mkbar events
```

Create a Summary of File Events

```
aureport -f -i --summary | mkbar files
```

Create a Summary of Login Events

```
aureport -l -i --summary | mkbar login
```

Create a Summary of User Events

```
aureport -u -i --summary | mkbar users
```

Create a Summary of System Call Events

```
aureport -s -i --summary | mkbar syscalls
```

To create a summary chart of failed events of any of the above event types, just add the `--failed` option to the respective `aureport` command. To cover a certain period of time only, use the `-ts` and `-te` options on `aureport`. Any of these commands can be tweaked further by narrowing down its scope using `grep` or `egrep` and regular expressions. See the comments in the `mkbar` script for an example. Any of the above commands produces a PNG file containing a bar chart of the requested data.

To illustrate the relationship between different kinds of audit objects, such as users and system calls, use the script `mkgraph`. Some example commands could look like the following:

Users versus Executables

```
LC_ALL=C aureport -u -i | awk '/^[0-9]/ { print $4 " "$7 }' | sort | uniq  
| mkgraph users_vs_exec
```

Users versus Files

```
LC_ALL=C aureport -f -i | awk '/^[0-9]/ { print $8 " "$4 }' | sort | uniq  
| mkgraph users_vs_files
```

System Calls versus Commands

```
LC_ALL=C aureport -s -i | awk '/^[0-9]/ { print $4 " "$6 }' | sort | uniq  
| mkgraph syscall_vs_com
```

System Calls versus Files

```
LC_ALL=C aureport -s -i | awk '/^[0-9]/ { print $5 " "$4 }' | sort | uniq  
| mkgraph | syscall_vs_file
```

Graphs can also be combined to illustrate complex relationships. See the comments in the `mkgraph` script for further information and an example. The graphs produced by this script are created in PostScript format by default, but you can change the output format by changing the `EXT` variable in the script from `ps` to `png` or `jpg`. To cover a certain period of time only, use the `-ts` and `-te` options on `aureport`.

Introducing an Audit Rule Set

32

The following example configuration illustrates how audit can be used to monitor your system. It highlights the most important items that need to be audited to cover the list of auditable events specified by Controlled Access Protection Profile (CAPP).

The example rule set is divided into the following sections:

- Basic audit configuration (see Section 32.1, “Adding Basic Audit Configuration Parameters” (page 432))
- Watches on audit log files and configuration files (see Section 32.2, “Adding Watches on Audit Log Files and Configuration Files” (page 433))
- Monitoring operations on file system objects (see Section 32.3, “Monitoring File System Objects” (page 434))
- Monitoring security databases (see Section 32.4, “Monitoring Security Configuration Files and Databases” (page 435))
- Monitoring miscellaneous system calls (Section 32.5, “Monitoring Miscellaneous System Calls” (page 438))
- Filtering system call arguments (see Section 32.6, “Filtering System Call Arguments” (page 438))

To transform this example into a configuration file to use in your live setup, proceed as follows:

- 1 Choose the appropriate settings for your setup and adjust them.
- 2 Adjust the file `/etc/audit/audit.rules` by adding rules from the examples below or by modifying existing rules.

NOTE: Adjusting the Level of Audit Logging

Do not copy the example below into your audit setup without adjusting it to your needs. Determine what and to what extent to audit.

The entire `audit.rules` is just a collection of `auditctl` commands. Every line in this file expands to a full `auditctl` command line. The syntax used in the rule set is the same as that of the `auditctl` command.

32.1 Adding Basic Audit Configuration Parameters

```
-D ❶  
-b 8192 ❷  
-f 2 ❸
```

- ❶ Delete any preexisting rules before starting to define new ones.
- ❷ Set the number of buffers to take the audit messages. Depending on the level of audit logging on your system, increase or decrease this figure.
- ❸ Set the failure flag to use when the kernel needs to handle critical errors. Possible values are 0 (silent), 1 (printk, print a failure message), and 2 (panic, halt the system).

By emptying the rule queue with the `-D` option, you make sure that audit does not use any other rule set than what you are offering it by means of this file. Choosing an appropriate buffer number (`-b`) is vital to avoid having your system fail because of too high an audit load. Choosing the panic failure flag `-f 2` ensures that your audit records are complete even if the system is encountering critical errors. By shutting down the

system on a critical error, audit makes sure that no process escapes from its control as it otherwise might if level 1 (`printk`) were chosen.

IMPORTANT: Choosing the Failure Flag

Before using your audit rule set on a live system, make sure that the setup has been thoroughly evaluated on test systems using the *worst case production workload*. It is even more critical that you do this when specifying the `-f 2` flag, because this instructs the kernel to panic (perform an immediate halt without flushing pending data to disk) if any thresholds are exceeded. Consider the use of the `-f 2` flag for only the most security-conscious environments.

32.2 Adding Watches on Audit Log Files and Configuration Files

Adding watches on your audit configuration files and the log files themselves ensures that you can track any attempt to tamper with the configuration files or detect any attempted accesses to the log files.

NOTE: Creating Directory and File Watches

Creating watches on a directory is not necessarily sufficient if you need events for file access. Events on directory access are only triggered when the directory's inode is updated with metadata changes. To trigger events on file access, add watches for each individual file to monitor.

```
-w /var/log/audit/ ❶
-w /var/log/audit/audit.log

#-w /var/log/audit/audit_log.1
#-w /var/log/audit/audit_log.2
#-w /var/log/audit/audit_log.3
#-w /var/log/audit/audit_log.4

-w /etc/audit/auditd.conf -p wa ❷
-w /etc/audit/audit.rules -p wa
-w /etc/libaudit.conf -p wa
-w /etc/sysconfig/auditd -p wa
```

- ❶ Set a watch on the directory where the audit log is located. Trigger an event for any type of access attempt to this directory. If you are using log rotation, add watches for the rotated logs as well.
- ❷ Set a watch on an audit configuration file. Log all write and attribute change attempts to this file.

32.3 Monitoring File System Objects

Auditing system calls helps track your system's activity well beyond the application level. By tracking file system–related system calls, get an idea of how your applications are using these system calls and determine whether that use is appropriate. By tracking mount and umount operations, track the use of external resources (removable media, remote file systems, etc.).

IMPORTANT: Auditing System Calls

Auditing system calls results in a high logging activity. This activity, in turn, puts a heavy load on the kernel. With a kernel less responsive than usual, the system's backlog and rate limits might be exceeded. Carefully evaluate which system calls to include in your audit rule set and adjust the log settings accordingly. See Section 30.2, “Configuring the Audit Daemon” (page 384) for details on how to tweak the relevant settings.

```
-a entry,always -S chmod -S fchmod -S chown -S chown32 -S fchown -S fchown32
-S lchown -S lchown32❶

-a entry,always -S creat -S open -S truncate -S truncate64 -S ftruncate -S
ftruncate64❷

-a entry,always -S mkdir -S rmdir❸

-a entry,always -S unlink -S rename -S link -S symlink❹

-a entry,always -S setxattr❺
-a entry,always -S lsetxattr
-a entry,always -S fsetxattr
-a entry,always -S removexattr
-a entry,always -S lremovexattr
-a entry,always -S fremovexattr

-a entry,always -S mknod❻

-a entry,always -S mount -S umount -S umount2❼
```

- ❶ Enable an audit context for system calls related to changing file ownership and permissions. Depending on the hardware architecture of your system, enable or disable the `*32` rules. 64-bit systems, like `x86_64` and `ia64`, require the `*32` rules to be removed.
- ❷ Enable an audit context for system calls related to file content modification. Depending on the hardware architecture of your system, enable or disable the `*64` rules. 64-bit systems, like `x86_64` and `ia64`, require the `*64` rules to be removed.
- ❸ Enable an audit context for any directory operation, like creating or removing a directory.
- ❹ Enable an audit context for any linking operation, such as `symlink`, `link`, `unlink`, or `rename`.
- ❺ Enable an audit context for any operation related to extended file system attributes.
- ❻ Enable an audit context for the `mknod` system call, which creates special (device) files.
- ❼ Enable an audit context for any mount or unmount operation. For the `x64_64` architecture, disable the `umount` rule. For the `ia64` architecture, disable the `umount2` rule.

32.4 Monitoring Security Configuration Files and Databases

To make sure that your system is not made to do undesired things, track any attempts to change the cron and at configurations or the lists of scheduled jobs. Tracking any write access to the user, group, password and login databases and logs helps you identify any attempts to manipulate your system's user database.

Tracking changes to your system configuration (kernel, services, time, etc.) helps you spot any attempts of others to manipulate essential functionality of your system. Changes to the PAM configuration should also be monitored in a secure environment, because changes in the authentication stack should not be made by anyone other than the administrator, and it should be logged which applications are using PAM and how it is used.

The same applies to any other configuration files related to secure authentication and communication.

❶

```
-w /var/spool/atspool
-w /etc/at.allow
-w /etc/at.deny

-w /etc/cron.allow -p wa
-w /etc/cron.deny -p wa
-w /etc/cron.d/ -p wa
-w /etc/cron.daily/ -p wa
-w /etc/cron.hourly/ -p wa
-w /etc/cron.monthly/ -p wa
-w /etc/cron.weekly/ -p wa
-w /etc/crontab -p wa
-w /var/spool/cron/root
```

❷

```
-w /etc/group -p wa
-w /etc/passwd -p wa
-w /etc/shadow

-w /etc/login.defs -p wa
-w /etc/securetty
-w /var/log/faillog
-w /var/log/lastlog
```

❸

```
-w /etc/hosts -p wa
-w /etc/sysconfig/

-w /etc/inittab -p wa
-w /etc/init.d/
-w /etc/init.d/auditd -p wa

-w /etc/ld.so.conf -p wa

-w /etc/localtime -p wa

-w /etc/sysctl.conf -p wa

-w /etc/modprobe.d/
-w /etc/modprobe.conf.local -p wa
-w /etc/modprobe.conf -p wa
```

❹

```
-w /etc/pam.d/
```

❺

```
-w /etc/aliases -p wa
-w /etc/postfix/ -p wa
```

⑥

```
-w /etc/ssh/sshd_config
```

```
-w /etc/stunnel/stunnel.conf
```

```
-w /etc/stunnel/stunnel.pem
```

```
-w /etc/vsftpd.ftpusers
```

```
-w /etc/vsftpd.conf
```

⑦

```
-a exit,always -S sethostname
```

```
-w /etc/issue -p wa
```

```
-w /etc/issue.net -p wa
```

- ① Set watches on the `at` and `cron` configuration and the scheduled jobs and assign labels to these events.
- ② Set watches on the user, group, password, and login databases and logs and set labels to better identify any login-related events, such as failed login attempts.
- ③ Set a watch and a label on the static hostname configuration in `/etc/hosts`. Track changes to the system configuration directory, `/etc/sysconfig`. Enable per-file watches if you are interested in file events. Set watches and labels for changes to the boot configuration in `/etc/inittab` and the `/etc/init.d` directory. Enable per-file watches if you are interested in file events. Set watches and labels for any changes to the linker configuration in `/etc/ld.so.conf`. Set watches and a label for `/etc/localtime`. Set watches and labels for the kernel configuration files `/etc/sysctl.conf`, `/etc/modprobe.d/`, `/etc/modprobe.conf.local`, and `/etc/modprobe.conf`.
- ④ Set watches on the PAM configuration directory. If you are interested in particular files below the directory level, add explicit watches to these files as well.
- ⑤ Set watches to the postfix configuration to log any write attempt or attribute change and use labels for better tracking in the logs.
- ⑥ Set watches and labels on the `ssh`, `stunnel`, and `vsftpd` configuration files.
- ⑦ Perform an audit of the `sethostname` system call and set watches and labels on the system identification configuration in `/etc/issue` and `/etc/issue.net`.

32.5 Monitoring Miscellaneous System Calls

As well as auditing file system related system calls, as described in Section 32.3, “Monitoring File System Objects” (page 434), you can also track various other system calls. Tracking task creation helps you understand your applications' behavior. Auditing the `umask` system call lets you track how processes modify permissions. Tracking any attempts to change the system time helps you identify anyone or any process trying to manipulate the system time.

❶

```
-a entry,always -S clone -S fork -S vfork
## For ia64 architecture, disable fork and vfork rules above, and
## enable the following:
#-a entry,always -S clone2
```

❷

```
-a entry,always -S umask
```

❸

```
-a entry,always -S adjtimex -S settimeofday
```

- ❶ Track task creation. To enable task tracking on the ia64 architecture, comment the first rule and enable the second one.
- ❷ Add an audit context to the `umask` system call.
- ❸ Track attempts to change the system time. `adjtimex` can be used to skew the time. `settimeofday` sets the absolute time.

32.6 Filtering System Call Arguments

In addition to the system call auditing introduced in Section 32.3, “Monitoring File System Objects” (page 434) and Section 32.5, “Monitoring Miscellaneous System Calls” (page 438), you can track application behavior to an even higher degree. Applying filters helps you focus audit on areas of primary interest to you. This section introduces filtering system call arguments for nonmultiplexed system calls like `access` and for multiplexed ones like `socketcall` or `ipc`. Whether system calls are multiplexed depends on the hardware architecture used. Both `socketcall` and `ipc` are not multiplexed on 64-bit architectures, such as `x86_64` and `ia64`.

IMPORTANT: Auditing System Calls

Auditing system calls results in high logging activity, which in turn puts a heavy load on the kernel. With a kernel less responsive than usual, the system's backlog and rate limits might well be exceeded. Carefully evaluate which system calls to include in your audit rule set and adjust the log settings accordingly. See Section 30.2, “Configuring the Audit Daemon” (page 384) for details on how to tweak the relevant settings.

The access system call checks whether a process would be allowed to read, write or test for the existence of a file or file system object. Using the `-F` filter flag, build rules matching specific access calls in the format `-F a1=access_mode`. Check `/usr/include/fcntl.h` for a list of possible arguments to the access system call.

```
-a entry,always -S access -F a1=4❶  
-a entry,always -S access -F a1=6❷  
-a entry,always -S access -F a1=7❸
```

- ❶ Audit the access system call, but only if the second argument of the system call (`mode`) is 4 (`R_OK`). This rule filters for all access calls testing for sufficient write permissions to a file or file system object accessed by a user or process.
- ❷ Audit the access system call, but only if the second argument of the system call (`mode`) is 6, meaning 4 OR 2, which translates to `R_OK OR W_OK`. This rule filters for access calls testing for sufficient read and write permissions.
- ❸ Audit the access system call, but only if the second argument of the system call (`mode`) is 7, meaning 4 OR 2 OR 1, which translates to `R_OK OR W_OK OR X_OK`. This rule filters for access calls testing for sufficient read, write, and execute permissions.

The `socketcall` system call is a multiplexed system call. Multiplexed means that there is only one system call for all possible calls and that `libc` passes the actual system call to use as the first argument (`a0`). Check the manual page of `socketcall` for possible system calls and refer to `/usr/src/linux/include/linux/net.h` for a list of possible argument values and system call names. Audit supports filtering for specific system calls using a `-F a0=syscall_number`.

```

-a entry,always -S socketcall -F a0=1 -F a1=10❶
## Use this line on x86_64, ia64 instead
#-a entry,always -S socket -F a0=10

-a entry,always -S socketcall -F a0=5❷
## Use this line on x86_64, ia64 instead
#-a entry, always -S accept

```

- ❶ Audit the `socket(PF_INET6)` system call. The `-F a0=1` filter matches all socket system calls and the `-F a1=10` filter narrows the matches down to socket system calls carrying the IPv6 protocol family domain parameter (`PF_INET6`). Check `/usr/src/linux/include/linux/net.h` for the first argument (`a0`) and `/usr/src/linux/include/linux/socket.h` for the second parameter (`a1`). 64-bit platforms, like `x86_64` and `ia64`, do not use multiplexing on `socketcall` system calls. For these platforms, comment the rule and add the plain system call rules with a filter on `PF_INET6`.
- ❷ Audit the `socketcall` system call. The filter flag is set to filter for `a0=5` as the first argument to `socketcall`, which translates to the `accept` system call if you check `/usr/include/linux/net.h`. 64-bit platforms, like `x86_64` and `ia64`, do not use multiplexing on `socketcall` system calls. For these platforms, comment the rule and add the plain system call rule without argument filtering.

The `ipc` system call is another example of multiplexed system calls. The actual call to invoke is determined by the first argument passed to the `ipc` system call. Filtering for these arguments helps you focus on those IPC calls of interest to you. Check `/usr/include/asm-generic/ipc.h` for possible argument values.

```

❶
## msgctl
-a entry,always -S ipc -F a0=14
## msgget
-a entry,always -S ipc -F a0=13
## Use these lines on x86_64, ia64 instead
#-a entry,always -S msgctl
#-a entry,always -S msgget

❷
## semctl
-a entry,always -S ipc -F a0=3
## semget
-a entry,always -S ipc -F a0=2
## semop
-a entry,always -S ipc -F a0=1
## semtimedop
-a entry,always -S ipc -F a0=4
## Use these lines on x86_64, ia64 instead

```

```
#-a entry,always -S semctl
#-a entry,always -S semget
#-a entry,always -S semop
#-a entry,always -S semtimedop
```

③

```
## shmctl
-a entry,always -S ipc -F a0=24
## shmget
-a entry,always -S ipc -F a0=23
## Use these lines on x86_64, ia64 instead
#-a entry,always -S shmctl
#-a entry,always -S shmget
```

- ① Audit system calls related to IPC SYSV message queues. In this case, the `a0` values specify that auditing is added for the `msgctl` and `msgget` system calls (14 and 13). 64-bit platforms, like `x86_64` and `ia64`, do not use multiplexing on `ipc` system calls. For these platforms, comment the first two rules and add the plain system call rules without argument filtering.
- ② Audit system calls related to IPC SYSV message semaphores. In this case, the `a0` values specify that auditing is added for the `semctl`, `semget`, `semop`, and `semtimedop` system calls (3, 2, 1, and 4). 64-bit platforms, like `x86_64` and `ia64`, do not use multiplexing on `ipc` system calls. For these platforms, comment the first four rules and add the plain system call rules without argument filtering.
- ③ Audit system calls related to IPC SYSV shared memory. In this case, the `a0` values specify that auditing is added for the `shmctl` and `shmget` system calls (24, 23). 64-bit platforms, like `x86_64` and `ia64`, do not use multiplexing on `ipc` system calls. For these platforms, comment the first two rules and add the plain system call rules without argument filtering.

32.7 Managing Audit Event Records Using Keys

After configuring a few rules generating events and populating the logs, you need to find a way to tell one event from the other. Using the `ausearch` command, you can filter the logs for various criteria. Using `ausearch -m message_type`, you can at least filter for events of a certain type. However, to be able to filter for events related to a particular rule, you need to add a key to this rule in the `/etc/audit/audit.rules` file. This key is then added to the event record every time the rule logs an

event. To retrieve these log entries, simply run `ausearch -k your_key` to get a list of records related to the rule carrying this particular key.

As an example, assume you have added the following rule to your rule file:

```
-w /etc/audit/audit.rules -p wa
```

Without a key assigned to it, you would probably have to filter for `SYSCALL` or `PATH` events then use `grep` or similar tools to isolate any events related to the above rule.

Now, add a key to the above rule, using the `-k` option:

```
-w /etc/audit/audit.rules -p wa -k CFG_audit.rules
```

You can specify any text string as key. Distinguish watches related to different types of files (configuration files or log files) from one another using different key prefixes (`CFG`, `LOG`, etc.) followed by the filename. Finding any records related to the above rule now comes down to the following:

```
ausearch -k CFG_audit.rules
----
time->Thu Feb 19 09:09:54 2009
type=PATH msg=audit(1235030994.032:8649): item=3 name="audit.rules~"
inode=370603 dev=08:06 mode=0100640 ouid=0 ogid=0 rdev=00:00
type=PATH msg=audit(1235030994.032:8649): item=2 name="audit.rules"
inode=370603 dev=08:06 mode=0100640 ouid=0 ogid=0 rdev=00:00
type=PATH msg=audit(1235030994.032:8649): item=1 name="/etc/audit"
inode=368599 dev=08:06 mode=040750 ouid=0 ogid=0 rdev=00:00
type=PATH msg=audit(1235030994.032:8649): item=0 name="/etc/audit"
inode=368599 dev=08:06 mode=040750 ouid=0 ogid=0 rdev=00:00
type=CWD msg=audit(1235030994.032:8649): cwd="/etc/audit"
type=SYSCALL msg=audit(1235030994.032:8649): arch=c000003e syscall=82
success=yes exit=0 a0=7deeb0 a1=883b30 a2=2 a3=ffffffffffffffff items=4
ppid=25400 pid=32619 auid=0 uid=0 gid=0 euid=0 suid=0 fsuid=0 egid=0 sgid=0
fsgid=0 tty=pts1 ses=1164 comm="vim" exe="/bin/vim-normal"
key="CFG_audit.rules"
```

Useful Resources

There are other resources available containing valuable information about the Linux audit framework:

The Audit Manual Pages

There are several man pages installed along with the audit tools that provide valuable and very detailed information:

`auditd(8)`

The Linux Audit daemon

`auditd.conf(5)`

The Linux Audit daemon configuration file

`auditctl(8)`

A utility to assist controlling the kernel's audit system

`autrace(8)`

A program similar to `strace`

`ausearch(8)`

A tool to query audit daemon logs

`aureport(8)`

A tool that produces summary reports of audit daemon logs

`audispd.conf(5)`

The audit event dispatcher configuration file

`audispd(8)`

The audit event dispatcher daemon talking to plugin programs.

<http://people.redhat.com/sgrubb/audit/index.html>

The home page of the Linux audit project. This site contains several specifications relating to different aspects of Linux audit, as well as a short FAQ.

`/usr/share/doc/packages/audit`

The audit package itself contains a README with basic design information and sample `.rules` files for different scenarios:

`capp.rules`: Controlled Access Protection Profile (CAPP)

`lspp.rules`: Labeled Security Protection Profile (LSPP)

`nispom.rules`: National Industrial Security Program Operating Manual Chapter 8(NISPOM)

`stig.rules`: Secure Technical Implementation Guide (STIG)

<http://www.commoncriteriaportal.org/>

The official Web site of the Common Criteria project. Learn all about the Common Criteria security certification initiative and which role audit plays in this framework.